

WISKA COMBI 108

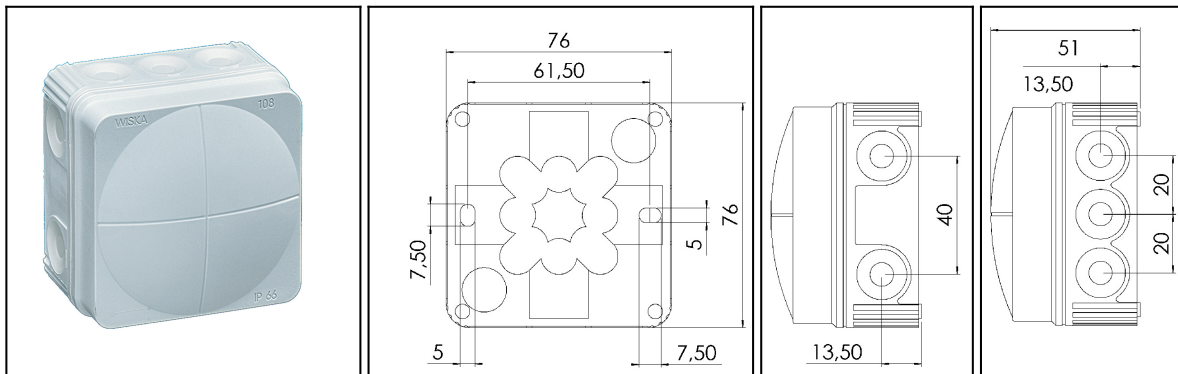

Protection class to EN 60 529:

Flame protection:

Temperature range:

Voltage:

Material:

Terminals/poles:

Fixing:

Equipment:

IP 66

glow wire test 750° C acc. to EN 60695-2-11

-5°C up to 60°C

400 V

Polypropylene, reinforced glass fibre; sealing: thermoplastic elastomere

2,5 mm²

With mounting clip for snap-on fixing or 2 internal openings outside of the sealing area

10 elastic self-sealing membranes for cable entry without mechanical devices at the side and 2 in the base

- Colour RAL 7035 light grey

- .../S = black

- .../W = white

- .../DR = grey box with red cover















- .../SMB = incl. mounting clip for snap-on fixing

Accessories:

- SMB 108: mounting clip for snap-on fixing, WISKA-No. 60528

- DN 48: screwing sleeves for fixing profile rails, WISKA-No. 60372

- DIN RAIL KIT 108, 308: Rail TS 35 + Fixing material, WISKA-No. 60362

Type	WISKA-No.		 mm		L x B x H external / außen mm
COMBI 108/leer	10060522	10/100	3 - 14		76 x 76 x 51
COMBI 108/leer/S	10061999	10/100	3 - 14		76 x 76 x 51
COMBI 108/leer/W	10060622	10/100	3 - 14		76 x 76 x 51
COMBI 108/leer/DR	10060632	10/100	3 - 14		76 x 76 x 51
COMBI 108/leer/SMB	10061974	10/100	3 - 14		76 x 76 x 51
COMBI 108/5	10060523	10/100	3 - 14		76 x 76 x 51
COMBI 108/5/S	10061998	10/100	3 - 14		76 x 76 x 51
COMBI 108/5/W	10060623	10/100	3 - 14		76 x 76 x 51
COMBI 108/FK 150	10060526	10/100	3 - 14		76 x 76 x 51
COMBI 108/FK 230	10060525	10/100	3 - 14		76 x 76 x 51
COMBI 108/FK 250	10060524	10/100	3 - 14		76 x 76 x 51