

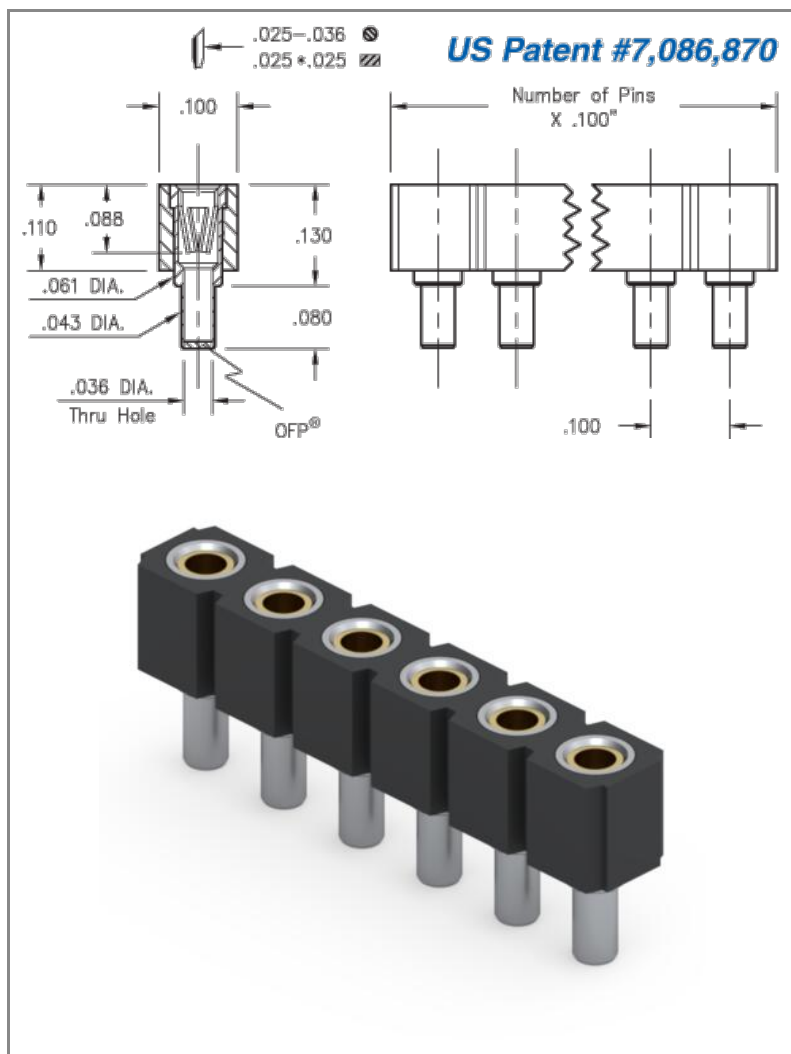

PRODUCT NUMBER: 834-43-006-10-001000

www.mill-max.com  
DATA SHEET



General Info	
<b>Description 1:</b>	Organic Fibre Plug Pass Thru Socket Accepts .025"-.036" (0,635-0,914mm) dia leads
<b>Type:</b>	Interconnect
<b>Category:</b>	Machined Pin Socket
<b>Mounting Style:</b>	Through Hole Solder Mount
<b># Pins:</b>	6
<b>Rows:</b>	Single Row
<b>Product Lifecycle:</b>	Active

## 834-43-006-10-001000- SPECIFICATIONS

Environmental Specs	
Temperature Range <sup>2</sup> :	-55/+125° C
RoHS <sup>3</sup> :	Yes

Materials	
Loose Pin/Receptacle # (Material):	3435 (Brass Alloy)
Shell Plating:	200 μ" Tin (matte finish) over 100 μ" Nickel
Inner Contact #:	47
# Contact Fingers:	6
Inner Contact Material:	Beryllium Copper
Inner Contact Plating:	30 μ" Gold over 50 μ" Nickel
Insulator Material:	High Temp Thermoplastic

Technical Specs	
Pitch:	.100" (2,540mm)

Electrical Specs	
Rated Voltage:	100 VRMS/150 VDC
Insulation Resistance:	10,000 MΩ min.
Dielectric Withstanding Voltage:	1,000 VRMS min.

## NOTES:

### 1. Standard Tolerances

Assembly tolerance: +/- .010" (.25mm)

Connector Length "L"

Connector Length "L"	Tolerance
$L \leq 2"$ ( $L \leq 50.8$ mm)	+/- .005" (+/- .127 mm)
$2 < L \leq 3"$ ( $50.8 < L \leq 76.2$ mm)	+ .007 / - .006" (+ .178 / - .152 mm)
$3 < L \leq 4"$ ( $76.2 < L \leq 101.6$ mm)	+ .009 / - .007" (+ .229 / - .178 mm)
$4 < L \leq 5"$ ( $101.6 < L \leq 127$ mm)	+ .011 / - .008" (+ .279 / - .203 mm)
$5 < L \leq 6.4"$ ( $127 < L \leq 162.56$ mm)	+ .013 / - .009" (+ .330 / - .229 mm)

Insulator width: +/- .005 (.13mm)

Insulator height: +/- .005 (.13mm)

Co-planarity of SMT connectors: .005" (.13mm) up to 1" (25.4mm) in connector length

Insulator Flatness: .005" (.13mm) up to 1" (25.4mm) in connector length

Pin Length: +/- .005 (.13mm)

Pin Diameter: +/- .002 (.051mm)

Pin Angle: +/- 2°

### 2. Per IEC 60512-11-(4,-9,-10,-12)

### 3. Mill-Max products labeled with the RoHS symbol are compliant with all three ROHS Directives. All of our products previously described as RoHS (2002/95/EC) and RoHS-2 (2011/65/EC) are also compliant with RoHS-3 (2015/863/EU).

## ADDITIONAL NOTES AND SPECIFICATIONS

In the interest of improved design, quality and performance, Mill-Max reserves the right to make changes in its specifications without prior notice. Specifications and tolerances are provided wherever possible. The tolerance on dimensions of critical to function features is typically held tighter than the stated standard tolerances, such as press-fits, holes and lengths affecting the coplanarity of SMT products. Due to the wide variety of interconnects Mill-Max offers, the specific tolerances vary from product to product. If you need information regarding the tolerance of a particular part, please contact Technical Services.

## RELATED LINKS AND DOCUMENTS

Application Note: ( [https://www.mill-max.com/sites/default/files/external/assets/2021-04/open-bottom\\_fibre\\_plug\\_receptacles\\_v4\\_0.pdf](https://www.mill-max.com/sites/default/files/external/assets/2021-04/open-bottom_fibre_plug_receptacles_v4_0.pdf) )

Engineering Notebook: ( <https://www.mill-max.com/engineering-notebooks/features-organic-fibre-plugr-pass-through-interconnects> )

Environmental Compliance: ( <https://www.mill-max.com/rohs> )