

AP2714SD

N and P-Channel Enhancement Mosfet

Feature

- **N-Channel**

$V_{DD}=40V, I_D=10A$

$R_{DS(on)} < 22m\Omega @ V_{GS}=10V$

$R_{DS(on)} < 30m\Omega @ V_{GS}=4.5V$

- **P-Channel**

$V_{DD}=-40V, I_D=-12A$

$R_{DS(on)} < 35m\Omega @ V_{GS}=-10V$

$R_{DS(on)} < 50m\Omega @ V_{GS}=-4.5V$

- Lead free product is acquired
- High power and current handling capability
- Surface mount package

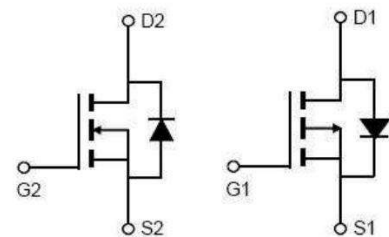

N-channel

P-channel

Schematic diagram

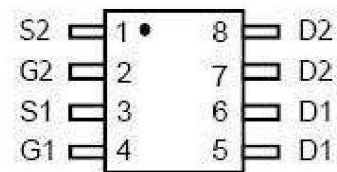

Marking and pin assignment

Application

- PWM applications
- Load Switch
- Power management

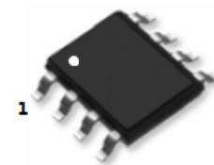

SOP-8

Package Marking and Ordering Information

Device Marking	Device	Device Package	Reel Size	Tape width	Quantity (PCS)
2714SD	AP2714SD	SOP-8	13 inch	-	4000

ABSOLUTE MAXIMUM RATINGS ($T_a=25^\circ\text{C}$ unless otherwise noted)

Parameter	Symbol	N-Channel	P-Channel	Unit
Drain-Source Voltage	V_{DS}	40	-40	V
Gate-Source Voltage	V_{GS}	± 20	± 20	V
Continuous Drain Current ($T_a = 25^\circ\text{C}$)	I_D	10	-12	A
Continuous Drain Current ($T_a = 100^\circ\text{C}$)	I_D	6.5	-7.2	A
Pulsed Drain Current ⁽¹⁾	I_{DM}	40	-45	A
Power Dissipation	P_D	4.0	7.5	W
Thermal Resistance from Junction to Ambient	$R_{\theta JA}$	31.3	16.7	$^\circ\text{C}/\text{W}$
Junction Temperature	T_J	150	150	$^\circ\text{C}$
Storage Temperature	T_{STG}	-55~ +150	-55~ +150	$^\circ\text{C}$

AP2714SD

N and P-Channel Enhancement Mosfet

AIIPOWER

DATA SHEET

N-CH ELECTRICAL CHARACTERISTICS($T_a=25^{\circ}\text{C}$ unless otherwise noted)

Parameter	Symbol	Test Condition	Min	Type	Max	Unit
Static Characteristics						
Drain-source breakdown voltage	$V_{(BR)DSS}$	$V_{GS} = 0V, I_D = -250\mu A$	40			V
Zero gate voltage drain current	I_{DSS}	$V_{DS} = 40V, V_{GS} = 0V$			1	μA
Gate-body leakage current	I_{GSS}	$V_{GS} = \pm 20V, V_{DS} = 0V$			± 100	nA
Gate threshold voltage ⁽²⁾	$V_{GS(th)}$	$V_{DS} = V_{GS}, I_D = 250\mu A$	1	1.6	2.5	V
Drain-source on-resistance ⁽²⁾	$R_{DS(on)}$	$V_{GS} = 10V, I_D = 10A$		17	22	m Ω
		$V_{GS} = 4.5V, I_D = 6A$		22	30	
Dynamic characteristics						
Input Capacitance	C_{iss}	$V_{DS} = 20V, V_{GS} = 0V, f = 1MHz$		1050		pF
Output Capacitance	C_{oss}			84		
Reverse Transfer Capacitance	C_{rss}			72		
Switching characteristics						
Turn-on delay time	$t_{d(on)}$	$V_{DD} = 20V, I_D = 5A, R_L = 6\Omega$ $V_{GS} = 10V, R_G = 1\Omega$		11		ns
Turn-on rise time	t_r			13		
Turn-off delay time	$t_{d(off)}$			36		
Turn-off fall time	t_f			9		
Total Gate Charge	Q_g	$V_{DS} = 20V, I_D = 5A,$ $V_{GS} = 10V$		11		nC
Gate-Source Charge	Q_{gs}			1.9		
Gate-Drain Charge	Q_{gd}			2.2		
Source-Drain Diode characteristics						
Diode Forward voltage ⁽²⁾	V_{DS}	$V_{GS} = 0V, I_S = 10A$			1.2	V
Diode Forward current ⁽³⁾	I_S		-	-	10	A

P-CH ELECTRICAL CHARACTERISTICS(T_a=25°C unless otherwise noted)

Parameter	Symbol	Test Condition	Min	Type	Max	Unit
Static Characteristics						
Drain-source breakdown voltage	V _{(BR)DSS}	V _{GS} = 0V, I _D = -250μA	-40			V
Zero gate voltage drain current	I _{DSS}	V _{DS} = -40V, V _{GS} = 0V			1	μA
Gate-body leakage current	I _{GSS}	V _{GS} = ±20V, V _{DS} = 0V			±100	nA
Gate threshold voltage ⁽²⁾	V _{GS(th)}	V _{DS} = V _{GS} , I _D = -250μA	-1	-1.6	-2.5	V
Drain-source on-resistance ⁽²⁾	R _{DS(on)}	V _{GS} = -10V, I _D = -8A		27	35	mΩ
		V _{GS} = -4.5V, I _D = -5A		35	50	
Dynamic characteristics						
Input Capacitance	C _{iss}	V _{DS} = -20V, V _{GS} = 0V, f = 1MHz		1415		pF
Output Capacitance	C _{oss}			134		
Reverse Transfer Capacitance	C _{rss}			102		
Switching characteristics						
Turn-on delay time	t _{d(on)}	V _{DD} = -20V, I _D = -5A, R _L = 6Ω V _{GS} = -10V, R _G = 1Ω		22		ns
Turn-on rise time	t _r			16		
Turn-off delay time	t _{d(off)}			59		
Turn-off fall time	t _f			6		
Total Gate Charge	Q _g	V _{DS} = -20V, I _D = -5A, V _{GS} = -10V		11.5		nC
Gate-Source Charge	Q _{gs}			3.5		
Gate-Drain Charge	Q _{gd}			3.2		
Source-Drain Diode characteristics						
Diode Forward voltage ⁽²⁾	V _{DS}	V _{GS} = 0V, I _S = -12A			1.2	V
Diode Forward current ⁽³⁾	I _S		-	-	-12	A

Notes:

1. Repetitive Rating: pulse width limited by maximum junction temperature
2. Pulse Test: pulse width ≤ 300μs, duty cycle ≤ 2%
3. Surface Mounted on FR4 Board, t ≤ 10 sec

N-Channel

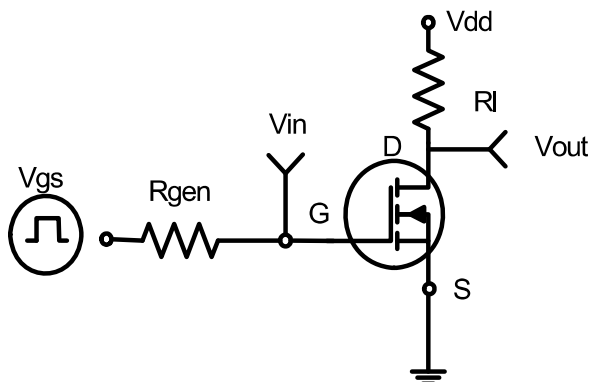

Figure 1: Switching Test Circuit

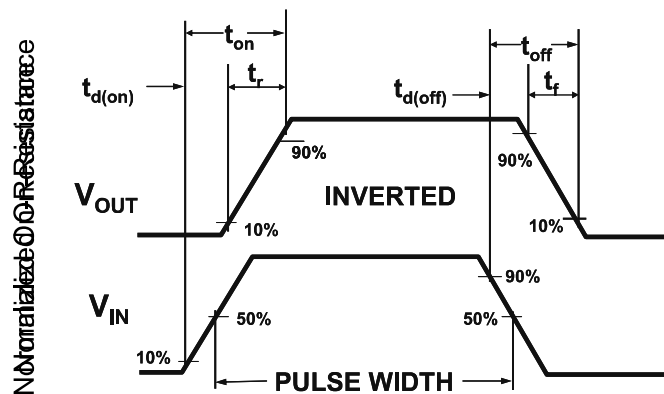

Figure 2: Switching Waveforms

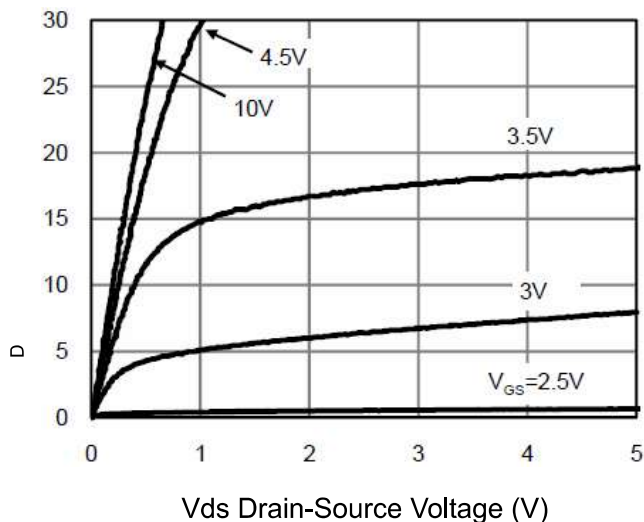

Figure 3 Output Characteristics

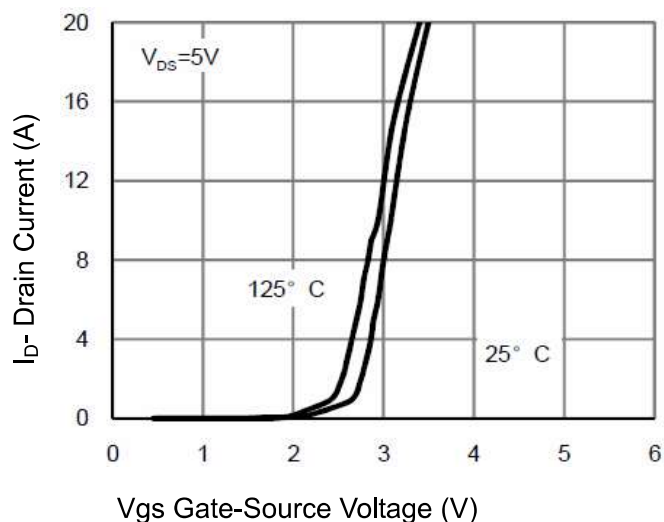

Figure 4 Transfer Characteristics

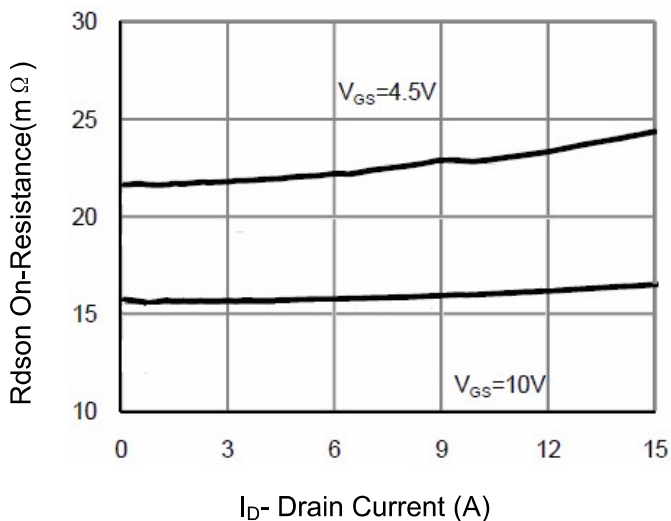

Figure 5 Drain-Source On-Resistance

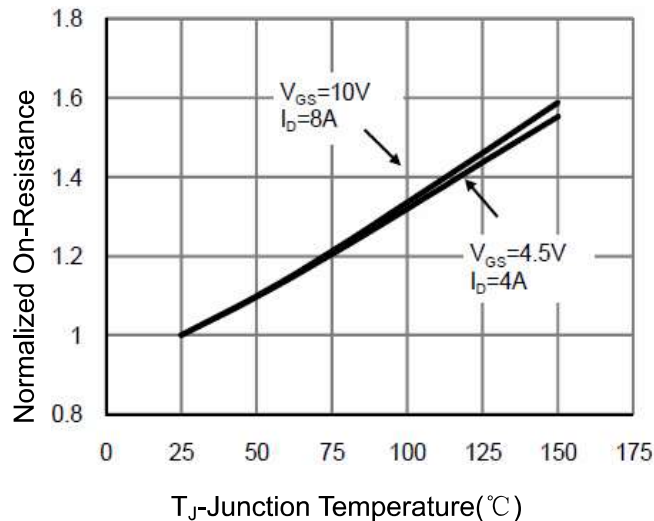
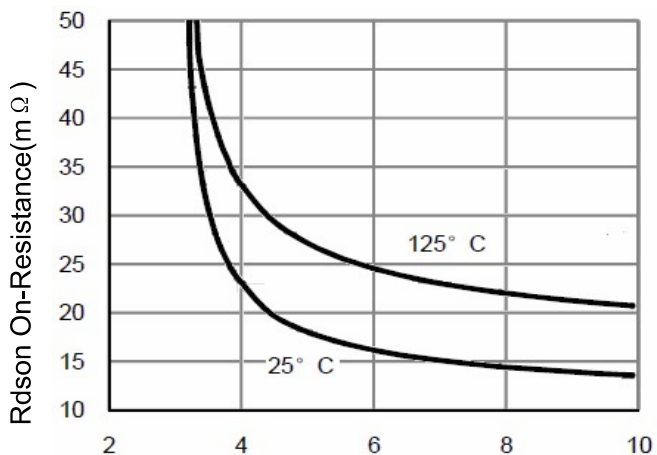
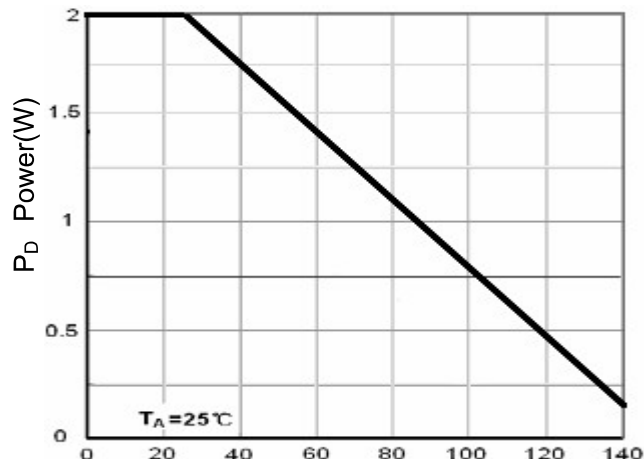

Figure 6 Drain-Source On-Resistance



Vgs Gate-Source Voltage (V)
Figure 7 Rdson vs Vgs



T_J-Junction Temperature(°C)
Figure 8 Power Dissipation

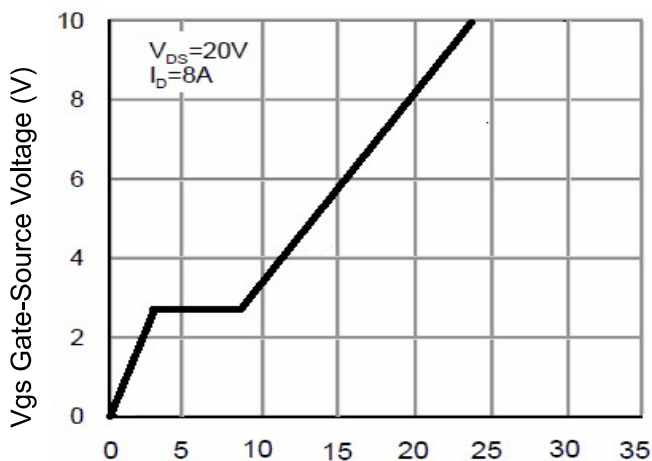

Qg Gate Charge (nC)
Figure 9 Gate Charge

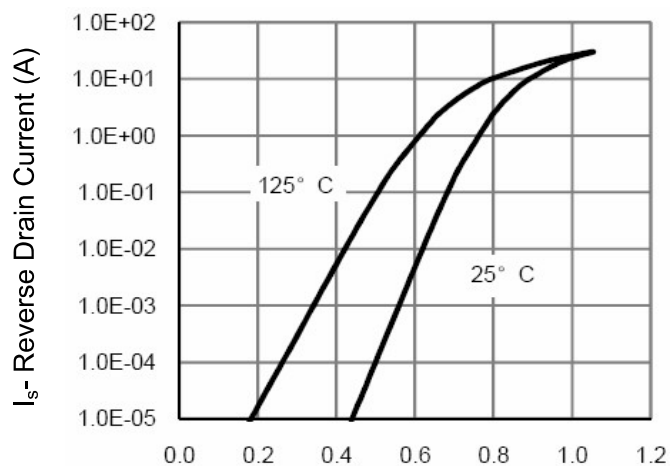

Vds Drain-Source Voltage (V)
Figure 10 Source- Drain Diode Forward

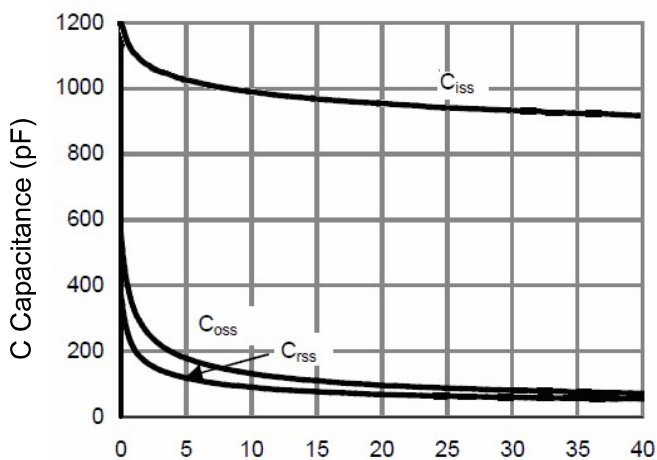

Vds Drain-Source Voltage (V)
Figure 11 Capacitance vs Vds

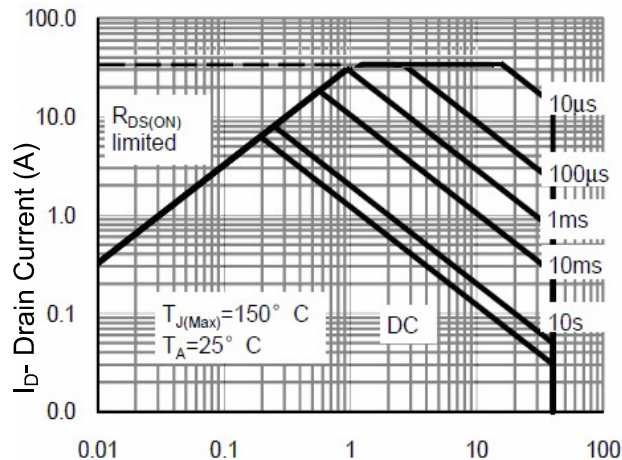

Vds Drain-Source Voltage (V)
Figure 12 Safe Operation Area

P-Channel

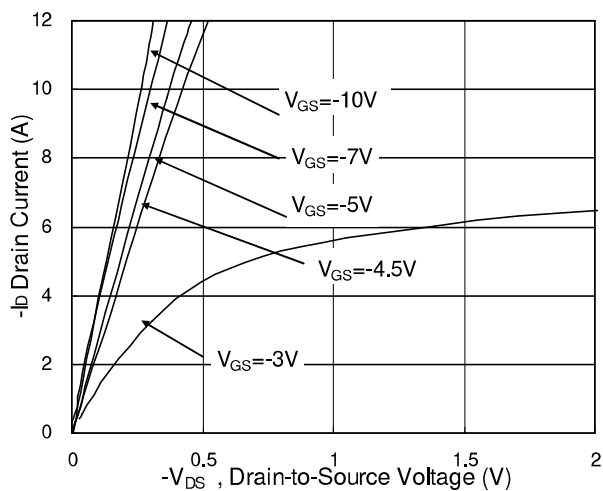

Fig.1 Typical Output Characteristics

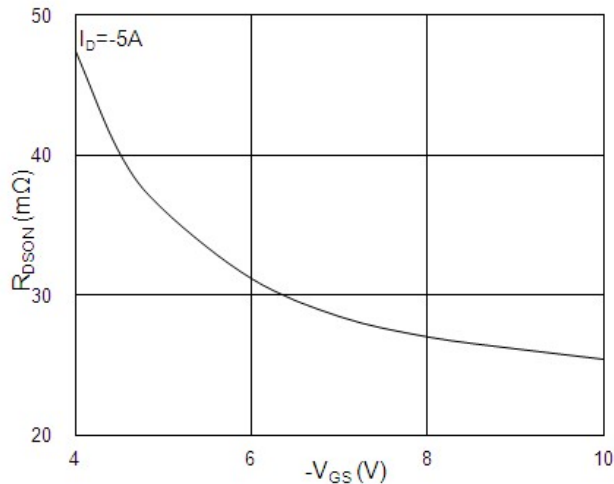

Fig.2 On-Resistance v.s Gate-Source

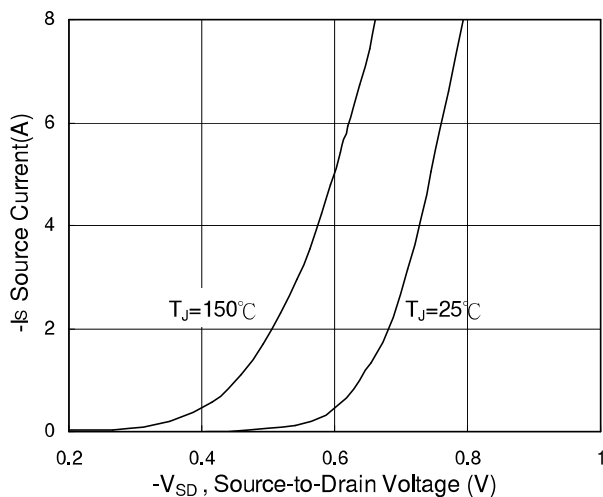

Fig.3 Forward Characteristics Of Reverse

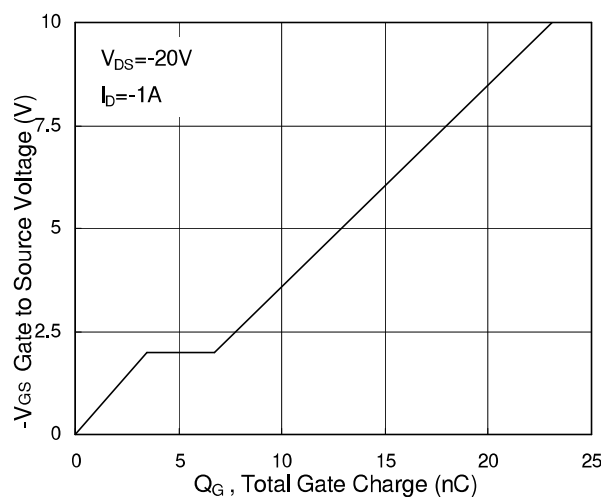

Fig.4 Gate Charge Characteristics

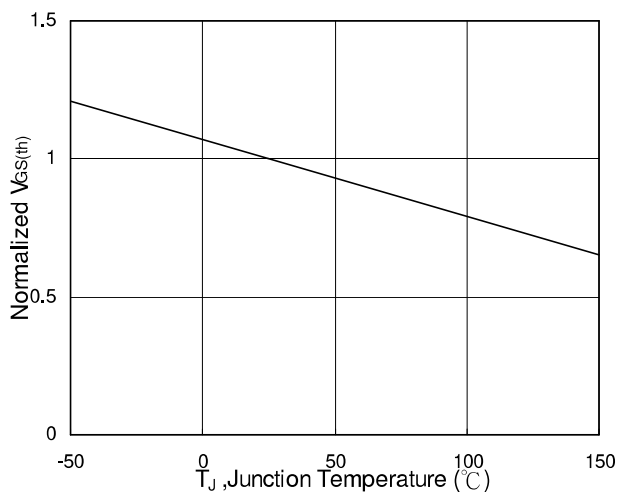

Fig.5 Normalized $V_{GS(th)}$ vs. T_J

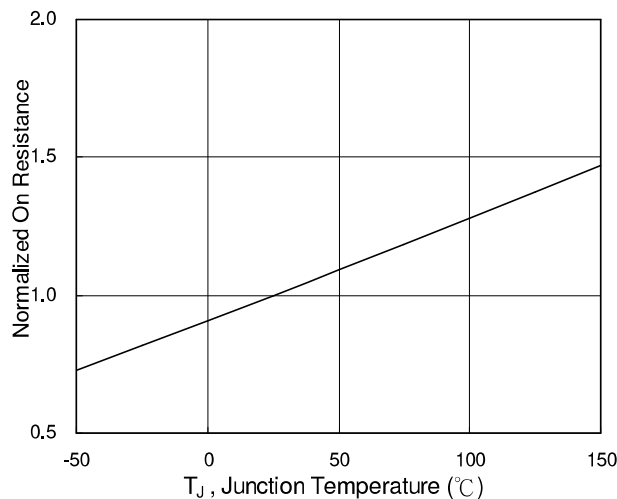

Fig.6 Normalized $R_{DS(on)}$ vs. T_J

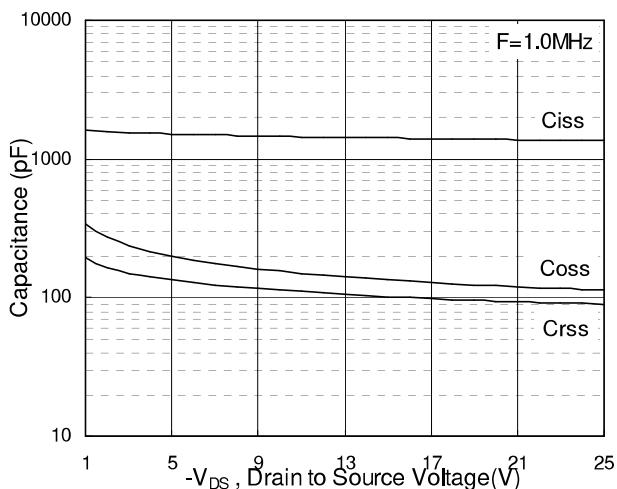

Fig.7 Capacitance

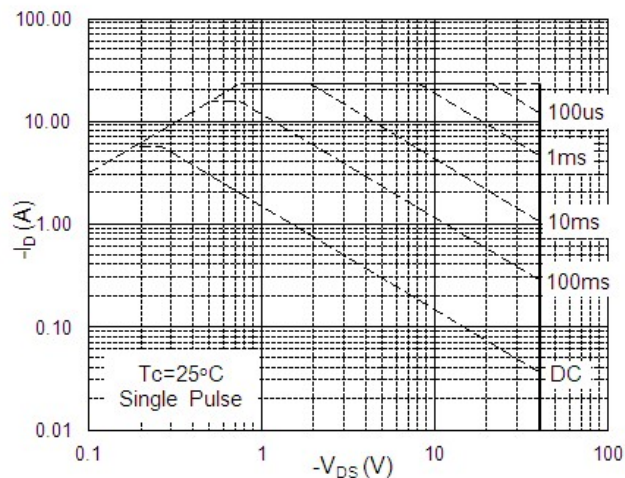

Fig.8 Safe Operating Area

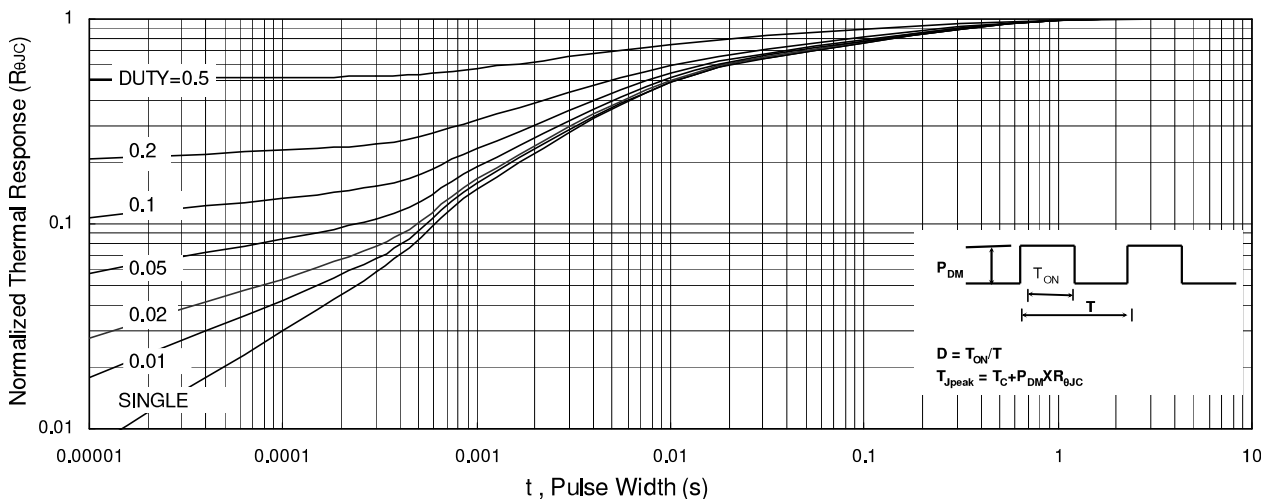

Fig.9 Normalized Maximum Transient Thermal Impedance

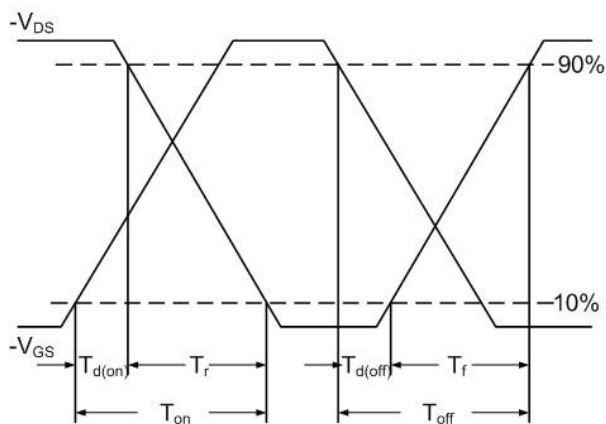

Fig.10 Switching Time Waveform

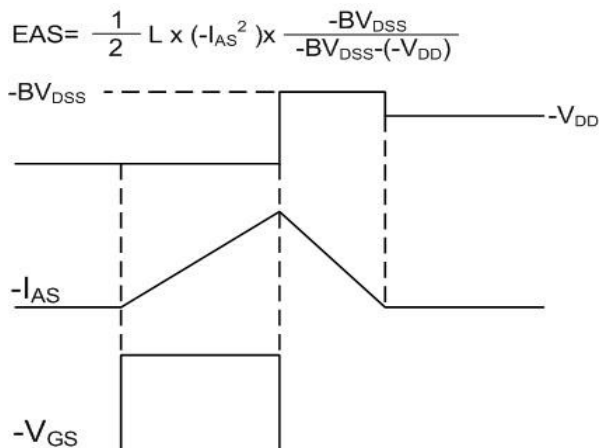
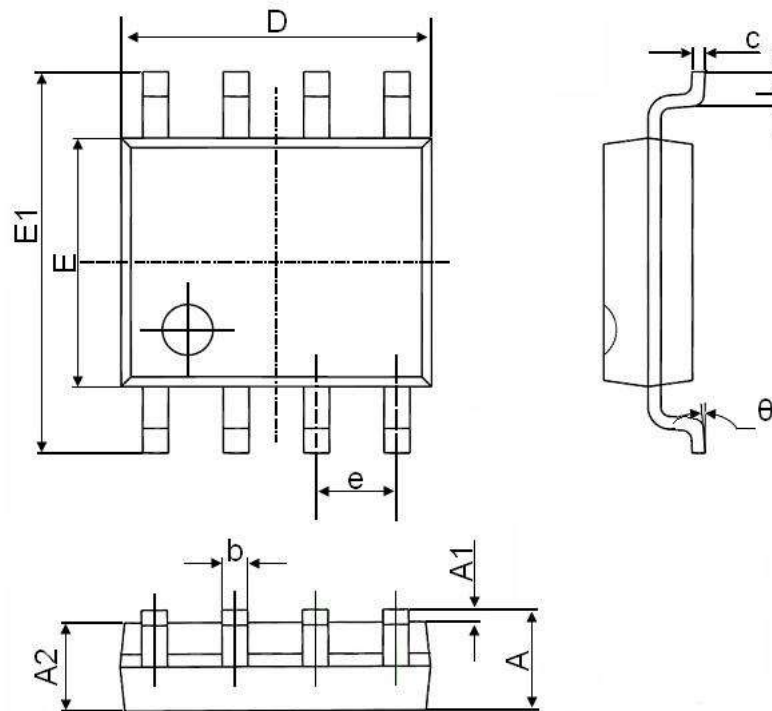

Fig.11 Unclamped Inductive Switching

SOP-8 Package Information



Symbol	Dimensions In Millimeters		Dimensions In Inches	
	Min.	Max.	Min.	Max.
A	1.350	1.750	0.053	0.069
A1	0.100	0.250	0.004	0.010
A2	1.350	1.550	0.053	0.061
b	0.330	0.510	0.013	0.020
c	0.170	0.250	0.006	0.010
D	4.700	5.100	0.185	0.200
E	3.800	4.000	0.150	0.157
E1	5.800	6.200	0.228	0.244
e	1.270(BSC)		0.050(BSC)	
L	0.400	1.270	0.016	0.050
θ	0°	8°	0°	8°