

# Hitaltech

A group of connecting technologies

 **Italtronic**<sup>®</sup> S.r.l.

## MODULBOX XTS 6MXTS B

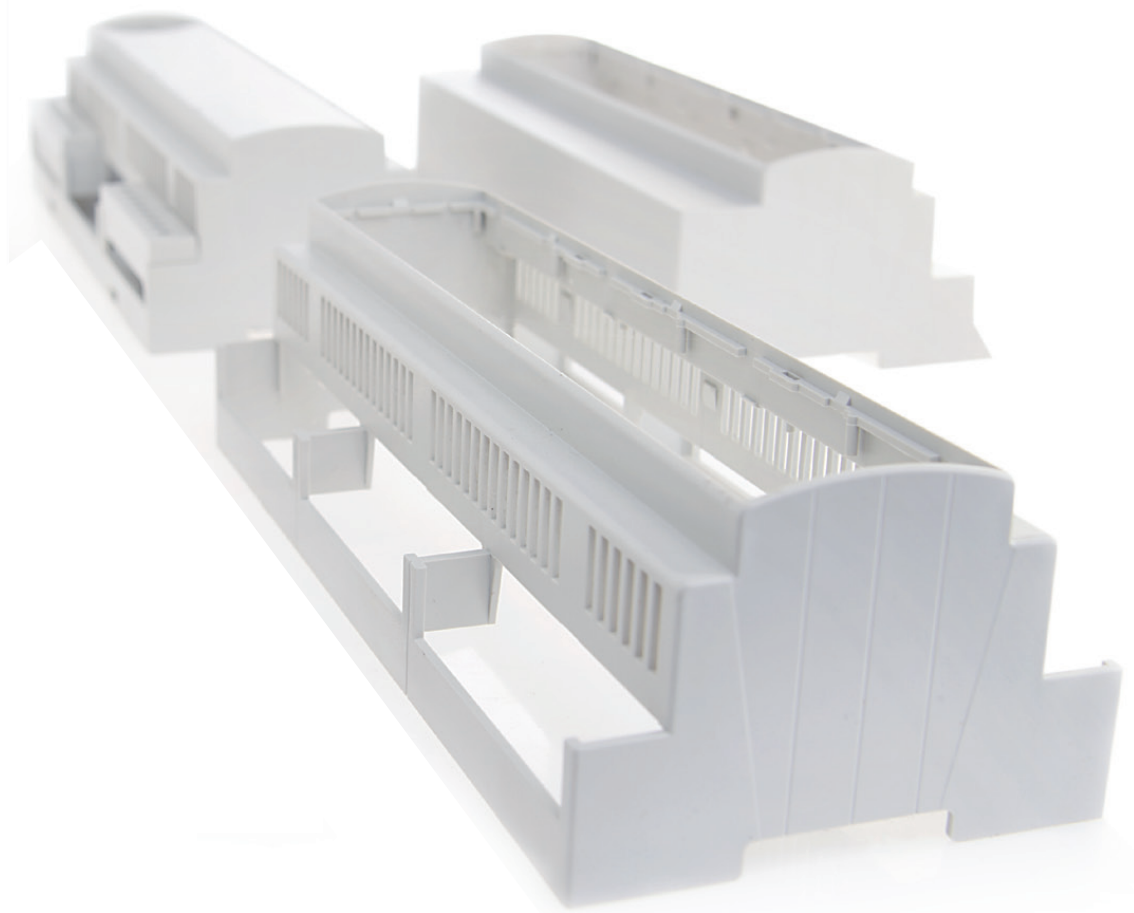

[www.hitaltech.co.uk](http://www.hitaltech.co.uk)

## Italtronic Srl. & Hitaltech



Italtronic Srl. based in Padova, Italy design and manufacture an innovative range of plastic enclosures to meet the needs of electronic and electrical applications across varying industries.

Hitaltech are pleased to be the appointed technical sales, marketing and master distributor for the UK & Ireland and US Market.

Through our knowledge and experience of the product Hitaltech aim to offer design engineers an Italtronic product which can meet their technical requirements.

The **Modulbox XT/XTS** is a DIN (EN 60715) mounting enclosure which has been designed according to DIN 43880 to meet the needs of a number of applications including heating & lighting control and energy metering.

Through a concept of flexible tooling all sides of the Modulbox XT can be customised.

2 to 12 Modules of this DIN Rail mounting enclosure are available in a standard height of 53mm.

Many customisation options are available which aim to meet any design challenge, including machining and/or machining of the enclosure & accessories to meet customer specific demands.

### MODULBOX XT MODULBOX XTS

Contenitori per strumentazione elettronica agganciabili su guida DIN (EN 60715) secondo norme DIN 43880

Materiale: Blend PC/ABS autoestinguente UL94-V0  
Colore: Grigio RAL 7035  
Misure: 2M, 3M, 4M, 5M, 6M, 8M, 9M, 12M

#### CARATTERISTICHE

Contenitore modulare da 2 a 12 moduli per strumentazione elettronica agganciabili su guida DIN (EN 60715). Pratico per la facilità di aggancio delle schede e per il montaggio del contenitore senza viti, MODULBOX XT - MODULBOX XTS si caratterizza per la vasta e completa gamma di combinazioni possibili che soddisfano le esigenze più particolari e specifiche della clientela. Diverse grandezze modulari e all'interno di queste più versioni disponibili, diversificata gamma di pannelli frontali, lavorazioni e serigrafie, chiusure particolari, sportelli di protezione piombabili, coprimorsetti e morsetti specifici: una molteplicità di opzioni e possibilità che soddisferanno ogni vostra esigenza e renderanno l'aspetto del vostro prodotto unico e personalizzato.

### MODULBOX XT MODULBOX XTS

DIN Rail (EN 60715) mounting enclosures for electronic products according to DIN 43880

Material: Self extinguishing Blend PC/ABS UL94-V0  
Colour: Grey RAL 7035  
Dimensions: 2M, 3M, 4M, 5M, 6M, 8M, 9M, 12M

#### FEATURES

MODULBOX is a DIN (EN 60715) mounting enclosure (modules from 2 up to 12) for electronic products. MODULBOX XT - MODULBOX XTS enclosures offer a wide range of matching options and possibilities which may satisfy any particular or specific Customers' need giving to the product a unique and personalized shape. They are characterized by the possibility to mount the enclosure itself without screws, by a great variety of modular sizes, diverse range of front panels, machining and silk-printing processes, specific panels, lead sealed protection panels, terminal covers and specific terminals.

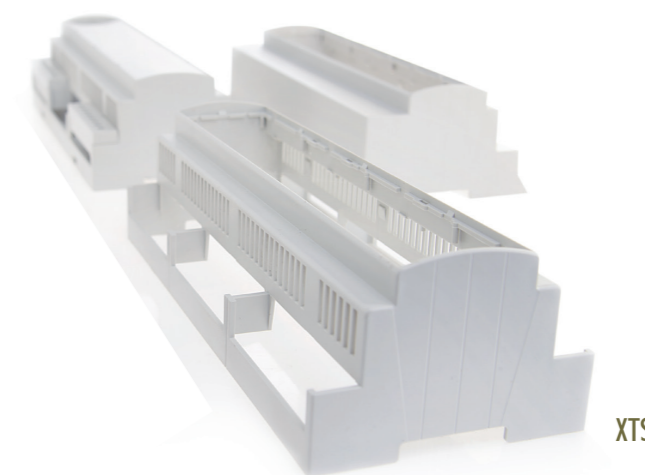

XTS

XTS shape is the version without the wings on bottom side of enclosure

MODULBOX XT MODULBOX XTS

MODULBOX XT

Norme DIN 43880/Standard DIN 43880

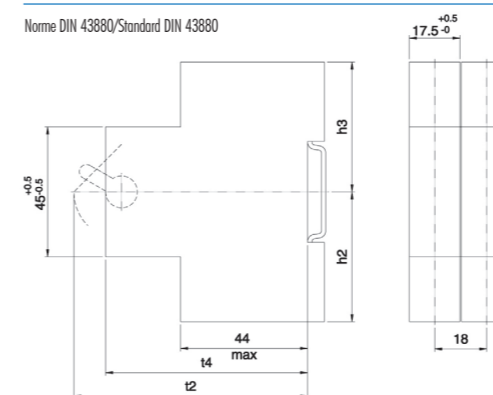

DIMENSIONI/DIMENSIONS	1	2	3
H2 max	45	55	75
H3 max	45	55	75
Ampere	Max 25 A	Max 63 A	Max 100 A
T2 max	55	70	92,5
T4 min	52	52	52
T4max	T2 max	T2 max	T2 max

Norme EN 60715/Standard EN 60715

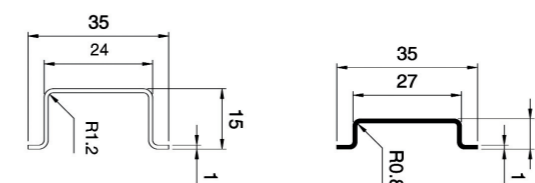

**MODULBOX XT MODULBOX XTS**

**La gamma completa a vostra disposizione**

**Materiale:** Blend PC/ABS autoestinguente UL94-V0  
**Colore:** Grigio RAL 7035  
**Misure:** 2M, 3M, 4M, 5M, 6M, 8M, 9M, 12M

**CIRCUITI STAMPATI**

Le esigenze dei Clienti sono numerose, perché molteplici sono i Clienti ed ognuno ha le proprie necessità. Italtronic ha fatto esperienza di questa evidenza del mercato ed ha trasformato la necessità di offrire una vasta gamma di prodotti in virtù. Proponiamo oggi infatti la gamma più completa in grado di soddisfare le esigenze più particolari dei nostri Clienti. Il contenitore modulare (da 2 a 12 moduli) è solo la base per la realizzazione di una innumerevole varietà di esecuzioni. Dietro al contenitore c'è un mondo di pannelli, chiusure, sistemi di aggancio, lavorazioni e serigrafie che renderanno l'aspetto del vostro prodotto unico così come unico e riconoscibile deve essere il vostro stile.

**Descrizione/Description:**

- 1) Corpo contenitore / Body Enclosure
- 2) Base / Base
- 3) Aggancio / Hook
- 4) Coprimorsetto\* / Terminal cover\*
- 5) Pannello\* / Panel\*

\* Accessori / Accessories

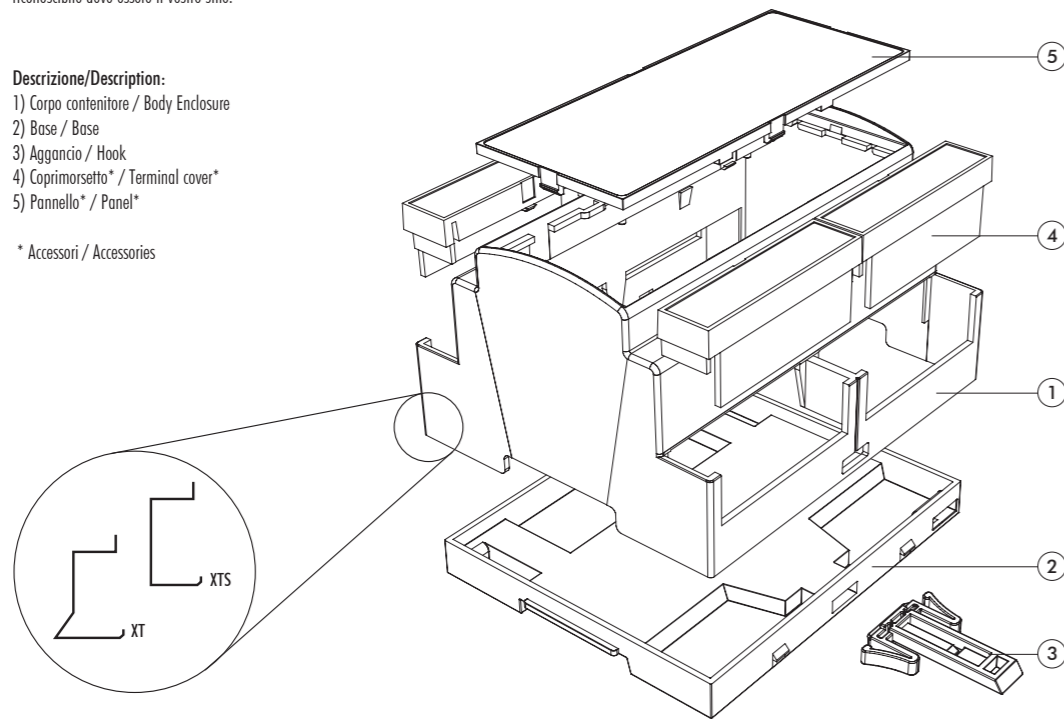

Vers. B

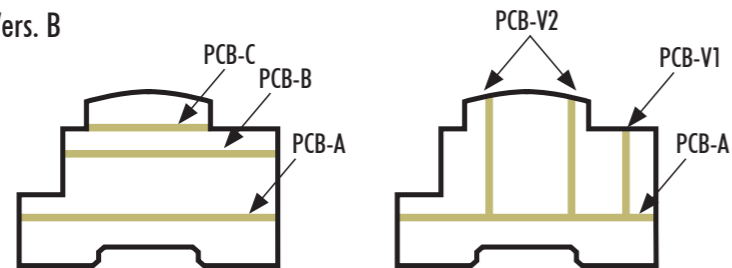

**MODULBOX XT MODULBOX XTS**

**The most complete range of options available**

**Material:** Self-extinguishing Blend PC/ABS UL94-V0  
**Colour:** Grey RAL 7035  
**Dimensions:** 2M, 3M, 4M, 5M, 6M, 8M, 9M, 12M

**PRINTED CIRCUIT BOARDS**

Customer demands are high due to the large number of customers: each with their own needs. Italtronic is aware of this market demand and now offers the widest range of products to meet the requirements of the most discerning customers. The modular enclosure (from 2 to 12 modules) is just a base on which Italtronic can insert a wide range of components. Making an enclosure involves many panels, terminal covers, fastening elements, machining and silk-screen printing processes, which make your product unique, just like your recognizable style.

**MODULBOX XT MODULBOX XTS**

**ITALTRONIC si avvicina alle esigenze del cliente.**

I contenitori della serie MODULBOX XT/XTS sono stampati impiegando stampi speciali sviluppati estremizzando al massimo il concetto di MODULARITÀ, che prevede la suddivisione nel maggior numero possibile lo stampo per iniezione plastica anziché la normale suddivisione in due parti di cui un matrice e un maschio. Ciò permette ad ITALTRONIC una maggiore flessibilità ed adattamento alle richieste della clientela perché può integrare e soddisfare meglio le necessità particolari di ogni cliente direttamente nello stampo per la produzione finale.

**Caratteristiche generali**

**SEQUENZA DI ASSEMBLAGGIO**

**MODULBOX XT MODULBOX XTS**

**ITALTRONIC is close to customer needs.**

The MODULBOX XT/XTS series enclosures are printed using special moulds developed to fully exploit the concept of modularity, allowing the plastic injection mould to be divided into as many parts possible instead of the usual two parts comprising a matrix and male. This gives ITALTRONIC more flexibility because it can integrate and better meet the needs of each customer directly in the mould for end products.

**General features**

**ASSEMBLY METHOD**



Contenitore disassemblato  
Disassembled enclosure



Montare la base  
Assemble the base

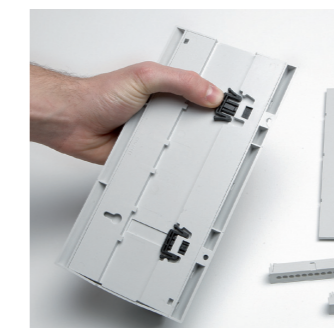

Montare il gancio  
Assemble the hook



Montare i coprimorsetti  
Assemble the terminal covers



Montare il pannello  
Assemble the panel



Contenitore assemblato  
Assembled enclosure

MODULBOX XTS

MODULBOX XTS

**Caratteristiche generali**  
SEQUENZA DI SMONTAGGIO

**General features**  
DISASSEMBLING METHOD



Contenitore assemblato  
Assembled enclosure



Rimuovere il pannello  
Remove the panel



Rimuovere i coprimorsetti  
Remove the terminal covers



Rimuovere il gancio  
Remove the hook



Rimuovere la base  
Remove the base



Contenitore disassemblato  
Disassembled enclosure

**PIOMBATURA**

Il prodotto MODULBOX XT - MODULBOX XTS è stato realizzato in modo da permettere con estrema facilità l'operazione di piombatura. Tale operazione consente di piombare tra loro la base ed il corpo contenitore. Per eseguire tale operazione non è necessario alcun componente aggiuntivo, essendo presenti sia sul corpo contenitore sia sulla base, dei fori appositamente predisposti.

**SEALING**

The product MODULBOX XT - MODULBOX XTS has been designed to allow easy sealing. Such a process allows the base and the body of the enclosure to be sealed together. In this processing, there is no need of additional components because some holes are present either on the base or on the body enclosure.



**DIN rail (EN60715) mounting enclosures for electronic products according to DIN 43880**

Material: Self extinguishing Blend PC/ABS  
Colour: Grey RAL 7035

**FEATURES**

This modular enclosure can be fastened to DIN (EN 60715) rail and can be provided with several terminal covers and various front panels. There are several versions of this modular enclosure: Type A (similar to the previous Modulbox product and bearing the same compatibility with the pcs), type B (with one side higher to leave more space for larger electronic components) and type C (with both sides higher to have more space for the electronic components).

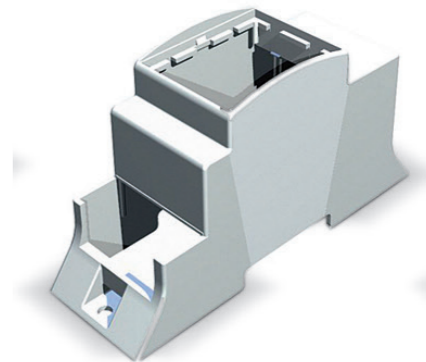

H53-B

Picture is an example of B version (picture shown is 25.0206000.BL)

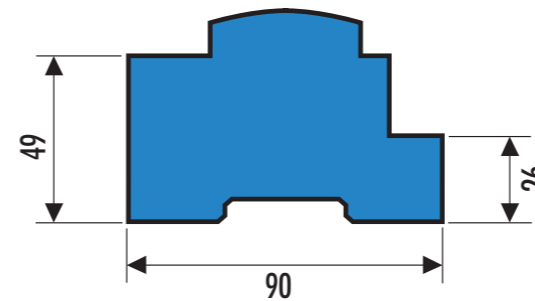

This type has one side higher to allow electronic components of bigger volume. It has been designed to allow the snap-in lock assembling of three different printed circuit boards (CSA, CSB e CSC).

H53: the standard version of type B is H53. This version maintains the possibility to assemble panels and terminal covers on one side only of the enclosure. Its side, next to the assembling area of the terminal blocks, is high.

It is possible to have special versions upon requests for a relatively low order quantity.

Part	Description
25.0606000.BL	COMPLETE ENCLOSURE MODULBOX XTS 6MH53-B (Includes, DIN Rail Hook)
<b>Optional Accessories (purchased separately) are listed below:</b>	
P05060201P.BL	6M Grey Panel with Frame - Accessory
P05060721P	6M Transparent Panel with Frame - Accessory
P05030201T.BL	3M Terminal cover, pre marked 5.08mm pitch - Accessory
P05030206T.BL	3M Terminal Cover, Blank - Accessory