

PV[®] WIRE-TO-BOARD CONNECTOR SYSTEM

UNIQUE DESIGN PROVIDES HIGH RELIABILITY, HIGH DURABILITY AND HIGH RETENTION

DESCRIPTION

The innovative PV[®] crimp-to-wire system connects discrete wire to printed circuit boards. High reliability dual-metal receptacle terminals plug to industry standard 0.025 inch (0.635mm) square posts. A variety of containment, protection and guidance options are available for both sides of the connector interface.

Wire side- PV[®] receptacle terminals can be terminated to wire and used discretely or inserted to multiple-circuit, MINI-LATCH connector housings that include optional polarizing keys.

Printed Circuit side- Shrouded multiple-post, headers include an integral friction feature that grips the sides of the mating MINI-LATCH housings and reduces the risk of disengagement. Other FCI header options include discrete staked pins or BergStik[®] un-shrouded headers.

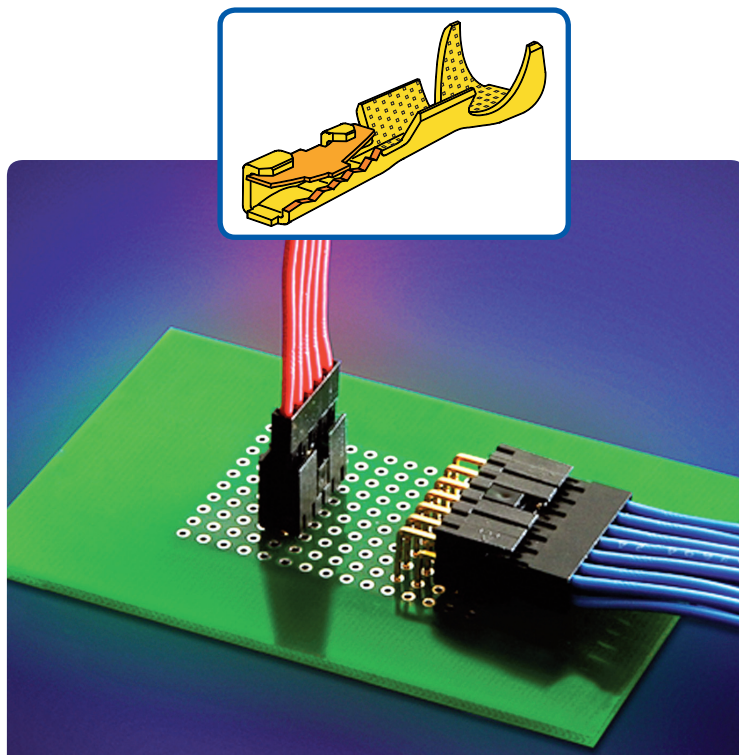

FEATURES & BENEFITS

- Unique dual-metal PV[®] receptacle contact maintains contact pressure through 1000 mating cycles. A beryllium copper spring provides high normal force at the mating interface, while the brass contact body produces a reliable, gas-tight crimp termination
- Choice of three different spring pressures allows the user to customize insertion and withdrawal forces to individual application requirements
- Shrouded header side walls engage with the sides of the MINI-LATCH housing to provide additional retention
- MINI-LATCH housing firmly retains PV[®] wire contacts
- Available in single or double row configurations
- Keyed MINI-LATCH housings and header keyways provide polarization to prevent mis-mating
- Two wall header design provides mechanical benefits plus economy
- Application tooling is supported by FCI

TARGET MARKETS / APPLICATIONS

- Instrumentation and Medical
- Industrial Equipment
- Consumer and White Goods
- Automotive Electronics
- Data and Communications
- Military and Avionics

basics 
The easy way to do business

PV® WIRE-TO-BOARD CONNECTOR SYSTEM

MINI-LATCH RECEPTACLE HOUSINGS

0.100 inch / 2.54 mm pitch

SINGLE ROW, POLARIZED, 78211 SERIES

Range: 03 to 15 positions

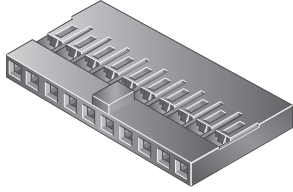

DOUBLE ROW, POLARIZED, 65846 SERIES

Range: 04 to 72 positions

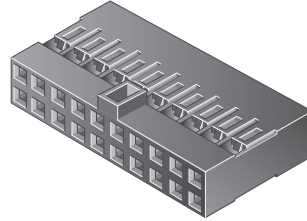

SINGLE ROW, 65039 SERIES

Range: 01 to 36 positions

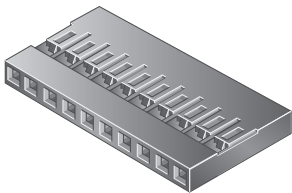

DOUBLE ROW, 65043 SERIES

Range: 04 to 72 positions

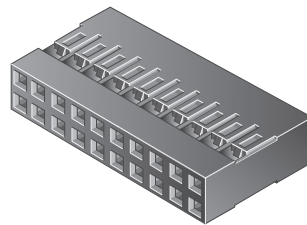

For specific part numbers, please consult drawings or www.fciconnect.com/pv
Maximum wire diameter for use in these housings is 1.52 mm

SHROUDED PCB HEADERS

0.100 inch / 2.54 mm pitch

SINGLE ROW, VERTICAL, 69167 SERIES

Range: 03 to 15 positions

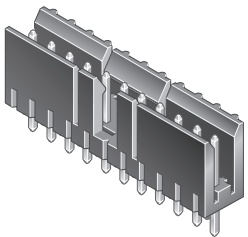

DOUBLE ROW, VERTICAL, 69168 SERIES

Range: 04 to 30 positions

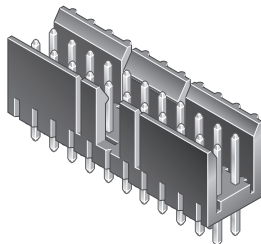

SINGLE ROW, RIGHT ANGLE 78208 SERIES

Range: 01 to 15 positions

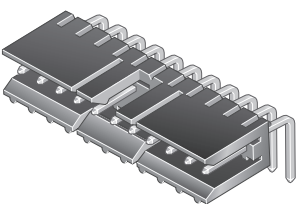

DOUBLE ROW, RIGHT ANGLE 78207 SERIES

Range: 04 to 30 positions

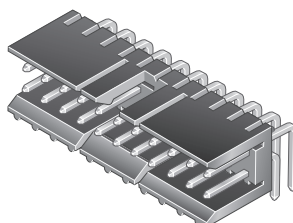

PART NUMBER CONSTRUCTION

PPPPP-ZNNHLF

PPPPP	= PCB Header Style
69167	= Single Row, Vertical
78208	= Single Row, Right Angle
69168	= Double Row, Vertical
78207	= Double Row, Right Angle

Z	= Plating Finish
1	= 30µin (0.76µm) Gold/GTX
2	= 15µin (0.38µm) Gold/GTX
4	= Pure Tin

NN	= Number of Positions
03 to 15	= available for Single Row
04 to 30	= available for Double Row

For detailed dimensions, connect to www.fciconnect.com/pv

PV[®] DUAL METAL CRIMP RECEPTACLE TERMINALS

For mating to 0.025 inch / 0.635 mm square posts

HOW TO SELECT THE RIGHT CONTACT

- STEP 1 = Select Application
- STEP 2 = Select Spring Force
- STEP 3 = Select Wire Size (AWG)
- STEP 4 = Select Plating

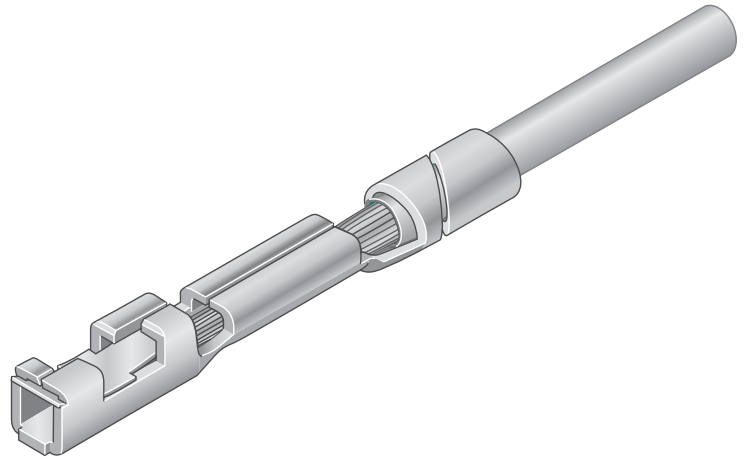

STEP 1

STEP 2

APPLICATION HOUSING

SPRING FORCE

40 - 72 contacts per housing	Standard
10 - 50 contacts per housing	High
02 - 20 contacts per housing	Ultra High
Discrete Contact	Ultra High

STEP 3

STEP 4

WIRE SIZE (AWG)	SPRING FORCE	PLATING / PACKAGING						
		REEL			BOX (Loose Piece)			
		Tin	15 u Gold (0.38µm)	30 u Gold (0.76µm)	40 u Gold (0.91µm) (Europe)	Tin	15 u Gold (0.38µm)	30 u Gold (0.76µm)
PV [®] PART NUMBERS								
18, 20 or two 22 or two 24	standard		48241-000LF	48231-000LF	48276-002LF		48250-000LF	48266-000LF
	high		48244-000LF	48047-002LF			48253-000LF	48232-000LF
	ultra-high	47648-000LF	48247-000LF	48252-000LF	47566-002LF	47749-000LF	48256-000LF	48233-000LF
22, 24, 26 or two 26 or two 28	standard	47445-000LF	48242-000LF	48049-000LF	47457-002LF		48251-000LF	48235-000LF
	high	47217-000LF	48245-000LF	48046-000LF	47439-002LF	47715-000LF	48254-000LF	48234-000LF
	ultra-high	47649-000LF	48248-000LF	48051-000LF	47565-002LF	47750-000LF	48257-000LF	48236-000LF
28, 30, 32 or two 30 or two 32	standard	47446-000LF	48243-000LF	48048-002LF		47748-000LF		48238-000LF
	high	47213-000LF	48246-000LF	48045-000LF	47437-002LF	47714-000LF	48255-000LF	48237-000LF
	ultra-high	47650-000LF	48249-000LF	48050-000LF	47564-002LF	47751-000LF	48258-000LF	48239-000LF
32, 34, 36	standard			75543-015LF				
	high	75543-007LF		75543-013LF		75543-008LF		75543-014LF
	ultra-high	75543-011LF		75543-017LF		75543-012LF		75543-018LF

= European Part Numbers

TECHNICAL INFORMATION

MATERIALS

- Contact Material:
 - PV® wire terminals: Brass body and Beryllium Copper spring
 - PCB headers: Phosphor bronze
- Contact Plating:
 - PV® wire terminals: Gold or lead-free pure tin over nickel
 - PCB headers: Gold or GXT™ (palladium-nickel with gold flash) or lead-free pure tin over nickel
- Housing Material:
 - MINI-LATCH Housings: Modified Polyphenylene Oxide UL 94-V0
 - Shrouded PCB Headers: Glass filled Nylon UL 94-V0
- All parts with “LF” suffix are RoHS compliant

ELECTRICAL CHARACTERISTICS

- Current Rating Single Circuit: 3.0 amps with 32 AWG wire; Larger wires allow more; All applications require de-rating
- Withstanding Voltage: 1000 V RMS
- Insulation Resistance, Wire Connector: >10000 Megohms
- Insulation Resistance, PCB Header: >5000 Megohms
- Contact Resistance (LLCR), Wire Connector: <2 milliohms

ELECTRICAL CHARACTERISTICS

- Mating Force (individual contact maximum)
 - High force spring: 450 grams
 - Ultra-high force spring: 1100 grams
- Un-mating Force (individual contact minimum)
 - High force spring: 75 grams
 - Ultra-high force spring: 175 grams
- PV® contact retention in MINI-LATCH Housing: 4 lbs per contact
- Durability: 1000 cycles
- Temperature: -40C to +105 C

APPROVALS AND CERTIFICATIONS

- UR E66906
- CSA LR46923

TECHNICAL DOCUMENTS

- Product Specification:
 - BUS-12-067 (PV® and MINI-LATCH Wire connectors)
 - BUS-12-075 (Shrouded PCB Headers)
- Application drawings: TA-75, TA-146, TA-531

APPLICATION TOOLING

■ PV-250A Semi-automatic Crimping Machine

- Easy to use
- Pneumatically operated
- Low cost
- Estimated 1000 crimps per hour

■ Machine Part Number

- 107416-101 (18-20AWG)
- 107416-102 (22-26AWG)
- 107416-103 (28-32AWG)

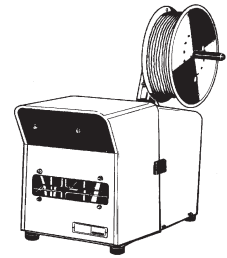

■ OL-740 Semi-automatic Two-Ton Bench Press

- Uses quick-changing, adjustable crimping applicators for different terminals and wire sizes
- Most rugged construction
- Easy to use
- Electrically operated
- Estimated 2400 crimps per hour

■ Machine Part Number

- 133911-102 (does not include app)

■ Applicator Tooling Part Numbers

- 133867-104 (18-20AWG)
- 133867-105 (22-26AWG)
- 133867-106 (28-32AWG)

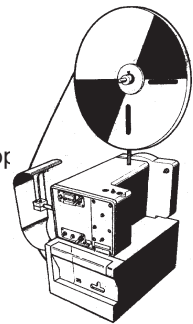

■ Ratcheting Hand Crimping Tool

■ Part Number

- HT-0073 (for 18-20 AWG Wire)
- HT-0095 (for 22-32 AWG Wire)
- HT-0112 (for 32-36 AWG Wire)

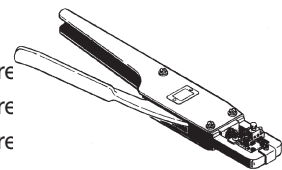

■ PV® Contact Removal Tool

■ Part Number

- HT-0080

