

CROWN CLIP Series Sockets

Product Facts

- Compact design
- High performance CROWN BAND contacts
- Currents to 350 Amps¹
- Mates with solid or laminated blades
- Supports true hot-plug (current interruption)²
- Float-mount option reduces mating forces
- Meets UL (USR & CNR), and CSA safety requirements
- All CROWN CLIP products in this section are RoHS compliant

Typical Applications

- Bus Bar based power distribution
- Power racks
- Rack mounted switching power supplies

Notes:

- 1 Dual CROWN CLIP socket using nickel plated mating tab, equivalent rating for other CROWN CLIP socket designs is 300A
- 2 Current interruption requires a gold plated, solid mating tab, and is not currently supported using a laminated mating tab



CROWN CLIP sockets are compact, high-current socket connectors for high current bus bar power distribution. Using ELCON high performance CROWN BAND technology, CROWN CLIP Sockets are available in single pole format to mate with a solid blade, handling up to 350 Amps, or in dual pole format to mate with laminated bus bar tabs for feed and return currents.

Product Highlights

Hot-Plug Design

CROWN CLIP sockets also comply with safety regulatory requirements for current interruption under load. Compliance is achieved by a contact design that restricts the effects of arcing to areas that do not compromise the integrity of the connection. Hot-plugging requires a gold plated mating blade.

Safety Agency Compliance

CROWN CLIP sockets comply with the UL1977 standard and CSA standard C22.2 No. 182.3-M1987. Tyco Electronics will work with customers to obtain application specific regulatory certifications if needed.



Sample Application

CROWN CLIP sockets allow hot-plugging of rack-mounted switching power supplies.

Photo reproduced courtesy of Unipower Corporation.

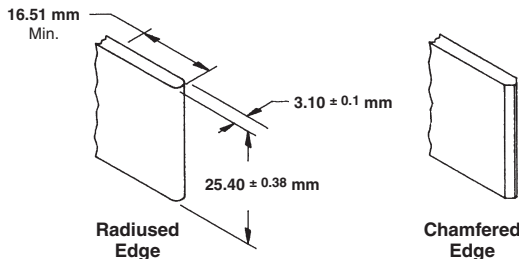

Mating Blades

Recommendations for customer supplied mating blades are:

Insertion Length — .650 [16.50] minimum, 1.00 [25.40] maximum

Thickness — .125 [3.18] or .118 [3.00]

Material — Copper, gold or nickel plated, with chamfered or rounded mating edge

Dimensions are in inches and millimeters unless otherwise specified. Values in brackets are metric equivalents.

Dimensions are shown for reference purposes only. Specifications subject to change.

USA: 1-800-522-6752
Canada: 1-905-470-4425
Mexico: 01-800-733-8926
C. America: 52-55-1106-0803

South America: 55-11-2103-6000
Hong Kong: 852-2735-1628
Japan: 81-44-844-8013
UK: 44-(0)8002-67666

CROWN CLIP Series Sockets (Continued)

Original CROWN CLIP Sockets

Part Number 1643906-1

Product Specifications

Materials

Insulator — Polyester, UL 94V-0

CROWN BAND Contacts — Beryllium copper alloy, selectively plated with gold (30 micro inches minimum), over nickel

Crown Holder — Copper alloy

Electrical

Current Rating, Steady State —

Nickel plated solid tab: 300 Amp maximum; 200 Amp at 30°C maximum temperature rise

Current Rating, Hot-Plug — Gold plated solid tab: 200 Amp maximum, 42V; 100 Amp maximum, 48V

Mechanical

Insertion Force — 10.0 lbs (4.54 Kg) maximum

Extraction Force — 5.0 lbs (2.72 Kg) minimum

Single pole, float-mount socket design delivers 300 Amp current capability plus current interruption.

Float-mount design provides alignment for blind-mating of rack-mounted power supply units. Parallel cantilever design contacts include

ELCON CROWN BAND contact elements to ensure low voltage drop and heat generation, plus consistent insertion and extraction forces. Current interruption ratings are 100A at 48V and 200A at 42V, both using a gold plated, solid tab.

Customer Drawing available upon request.

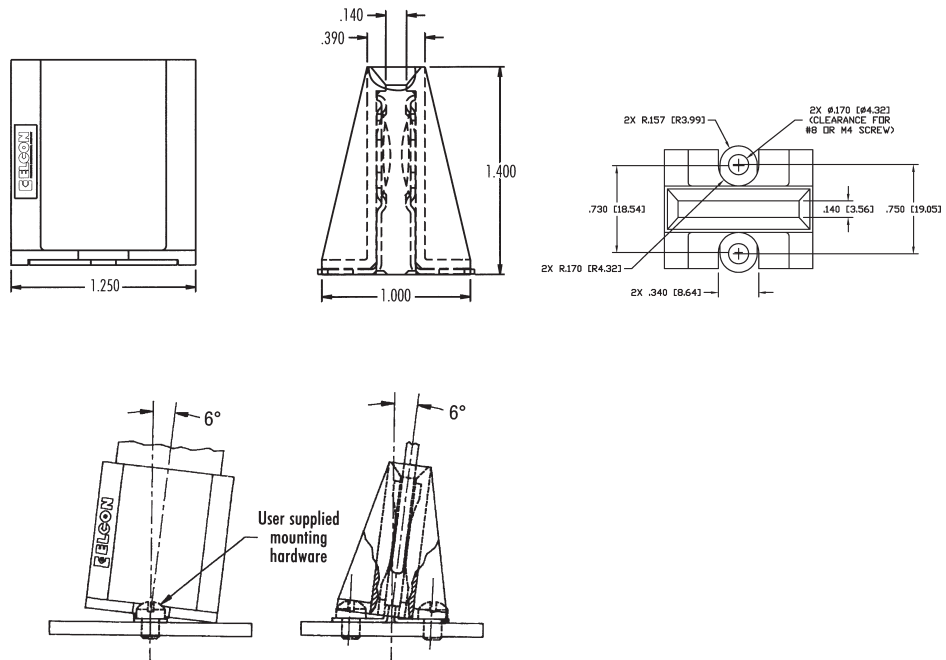

CROWN CLIP Sockets Electrical Performance

The graph at right shows the electrical performance of CROWN CLIP sockets in terms of temperature rise and volt-age drop at currents from 150 Amps to 350 Amps. The set up used for the test had six CROWN CLIP socket samples mounted on a .25" x 1.75" x 6.0" bus bar, mating with 1.0" long by .125" thick nickel plated blades connected in series using 1/0 AWG wire.

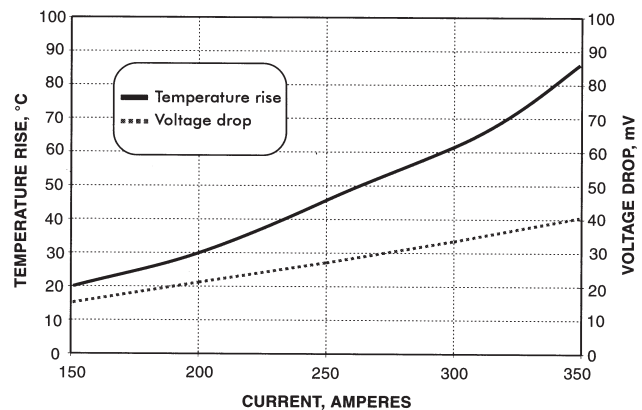

Note: All part numbers are RoHS compliant.

CROWN CLIP Series Sockets (Continued)

**CROWN CLIP II Sockets
Part Number 1643903-1**

Product Specifications

Materials

Insulator — Polyester, UL 94V-0
Contact — Copper alloy, selectively plated with gold (30 micro inches minimum), over nickel

Electrical

Current Rating, Steady State — Nickel plated solid tab: 300 Amp maximum; 230 Amp at 30°C maximum temperature rise

Current Rating, Hot-Plug — Gold plated solid tab: 200 Amp maximum, 42V; 100 Amp maximum, 48V

Mechanical

Insertion Force — 20.0 lbs (9.08 Kg) typical

Extraction Force — 10.0 lbs (4.54 Kg) typical

Dual pole, float-mount socket design delivers 300 Amp current capability plus current interruption.

Float-mount design provides alignment for blind-mating of rack-mounted power supply units. The dual pole contact design allows mating

to a two pole laminated bus bar or double sided PCB tab, adding design flexibility by providing feed and return using a single socket. Current interruption ratings are 100 A at 48 V and 200 A at 42 V, both using a gold plated, solid tab.

Customer Drawing available upon request.

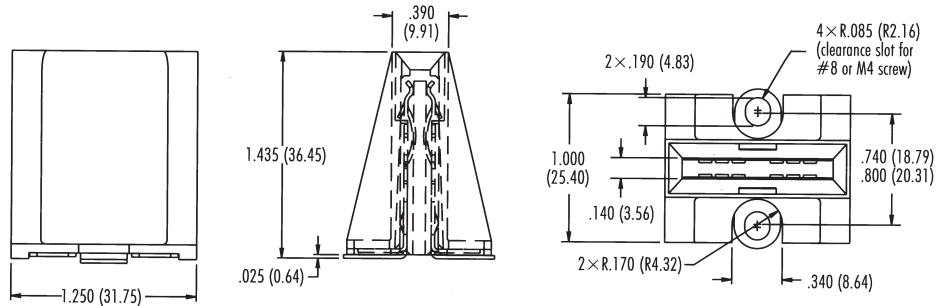

CROWN CLIP Sockets II Connector Electrical Performance

The graphs below show the electrical performance of CROWN CLIP II sockets in terms of temperature rise and voltage drop at currents from 150 Amps to 350 Amps. The set up used for the test had samples of six CROWN CLIP sockets mounted on a .25" x 1.75" x 6.0" bus bar, mating with 1.0" long by .125" thick nickel plated blades connected in series using 1/0 AWG wire.

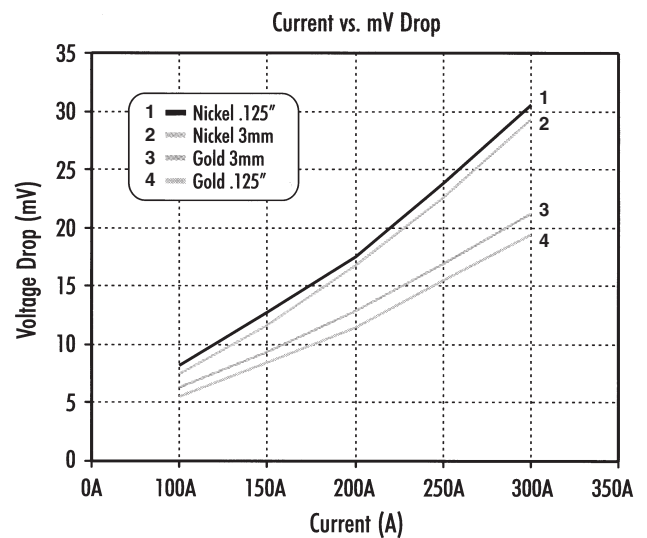
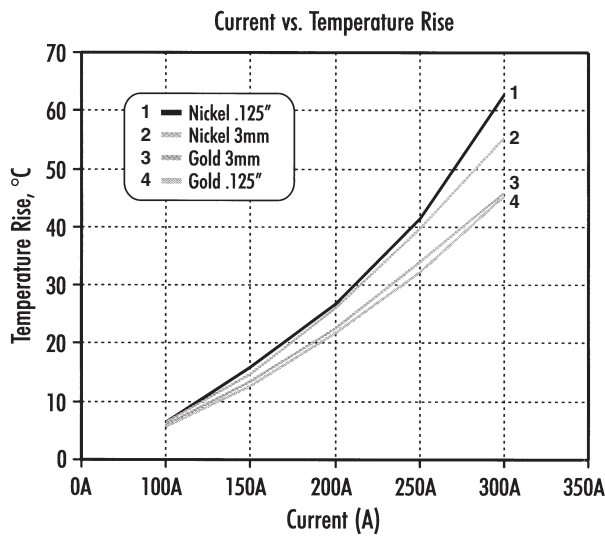

Note: All part numbers are RoHS compliant.

CROWN CLIP Series Sockets (Continued)

**Dual CROWN CLIP Sockets
Part Numbers 1926671-1**

Product Specifications

Materials

Insulator — Polyester, UL 94V-0
CROWN BAND — Beryllium copper alloy, selectively plated with gold (30 micro inches minimum), over nickel
Crown Holder — Copper alloy

Electrical

Current Rating, Steady State — Nickel plated solid tab: 350 Amp maximum; 225 Amp at 30°C maximum temperature rise

Current Rating, Steady State — Laminated bus bar tab: 130 Amp per side (260 A total) maximum; 75 Amp per side (150 A total) at 30°C maximum temperature rise

Current Rating, Hot-Plug — Gold plated solid tab: 200 Amp maximum, 5V; 100 Amp maximum, 60V

Mechanical

Insertion Force — 20.0 lbs (9.08 Kg) typical

Extraction Force — 13.0 lbs (5.9 Kg) typical

Dual pole, feed-through socket design delivers 350 Amp current capability plus current interruption. The dual pole contact design allows mating to a two pole laminated bus bar or double sided PCB tab, adding design flexibility by providing feed and return using a single socket. The feed-through design aspect allows insertion of mating

blade from both top and bottom of socket. The contacts include ELCON CROWN BAND contact elements to help provide low voltage drop and heat generation, plus consistent insertion and extraction forces. Current interruption ratings are 100A at 60V and 200A at 5V, both using a gold plated, solid tab.



Feed-Thru View

Customer Drawing available upon request.

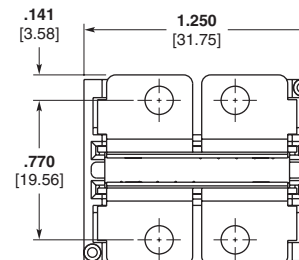
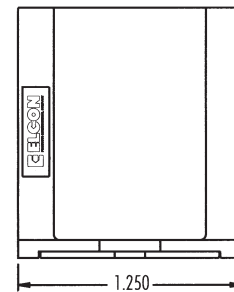
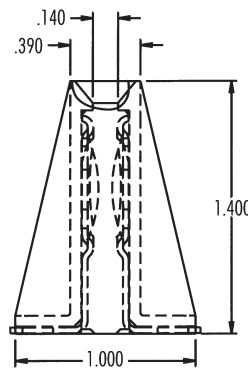

Part Number 1926671-1
4-hole CROWN CLIP
300A

Sample Application

ELCON Dual CROWN CLIP connectors mounted on a laminated power distribution bus bar in a large server.



Photos reproduced courtesy of Eldre Corporation

Note: All part numbers are RoHS compliant.

CROWN CLIP Series Sockets (Continued)

CROWN CLIP Junior
Direct Power Connection
for Bus Bars

Product Facts

- **Current: 150 A**
- **Mating Force: 40 N max.**
- **Mating Bus Bar Thickness: 3.0 ± 0.1 mm**
- **Bus Bar misalignment: ± 1.0 mm**
- **Hot Pluggable**
- **Contact Resistance: 0.2 milliohms**
- **Blind Mateable**
- **Anti Over Stress Feature**
- **Reduced Installation Costs**
- **Screw Fix or PC Tail Option**

Technical Documents

Product Specification
108-19360

Application Specification
114-19128

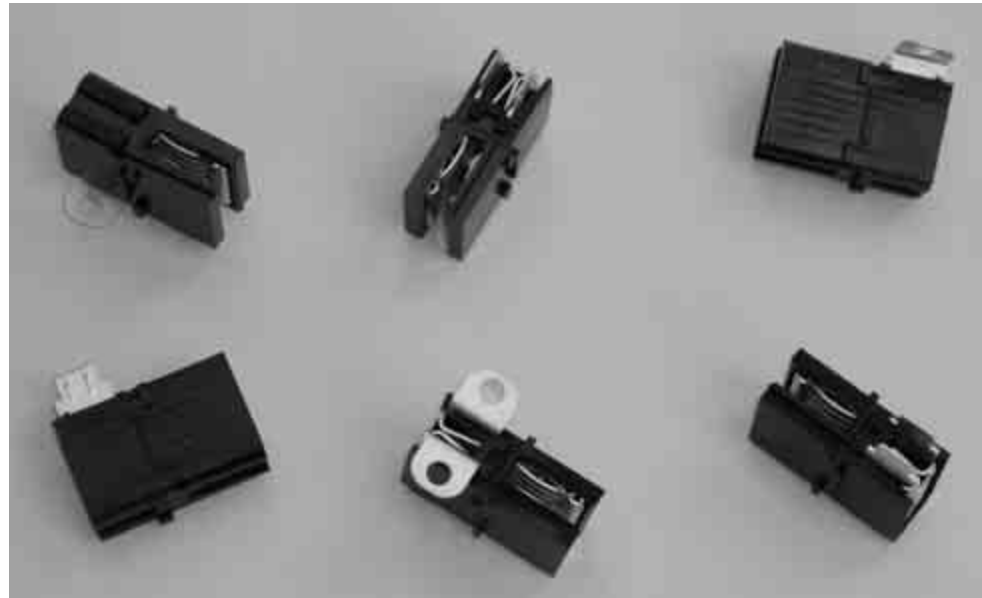

Applications

- **Core Network Energy Systems**
- **Cellular Base Stations**
- **PSU Power Distribution**
- **Servers, Storage & Network Routers**
- **Industrial**

The CROWN CLIP Junior connector provides a space efficient connector in solder or screw-mount configurations ideal for power supply/distribution applications. Satisfying the demand for low insertion/extraction forces, it is hot plug capable for controlled and reliable separation of high power.

The connector mates to a 3.0 mm thick plated bus bar that provides a separable interface to ease assembly, inspection and trouble shooting. The selective

plated, high conductivity copper contacts offer low resistance, low millivolt drop for efficient power distribution. In blind mate applications this connector can handle adverse tolerances through the unique anti-stress feature allowing reliable mating to misaligned bus bars.

The CROWN CLIP Junior connector can be soldered direct to a PCB or screwed to a bus bar for a 150 A current capacity.

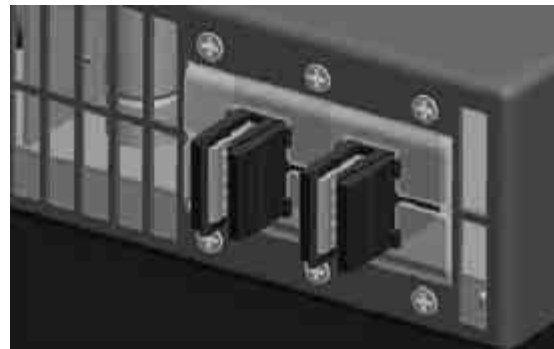

Pluggable Bus Bar Connectors

Product Facts

- Separable bus bar connector
- 062 series for .062" [1.57] thick, 1/2" [12.7] minimum width bus bar
- 125 series for .125" [3.18] thick, 1" [25.4] minimum width bus bar
- Mounts direct to bus bar or terminated wire
- Low resistance, low millivolt drop
- High current rating: up to 500 amps for 125 series and 250 amps for 062 series
- Blind mateable (misalignment up to ± .060" [1.52 mm] for both series)
- Anti-overstress feature
- Component Recognition Underwriter's Laboratories File No. E113407 

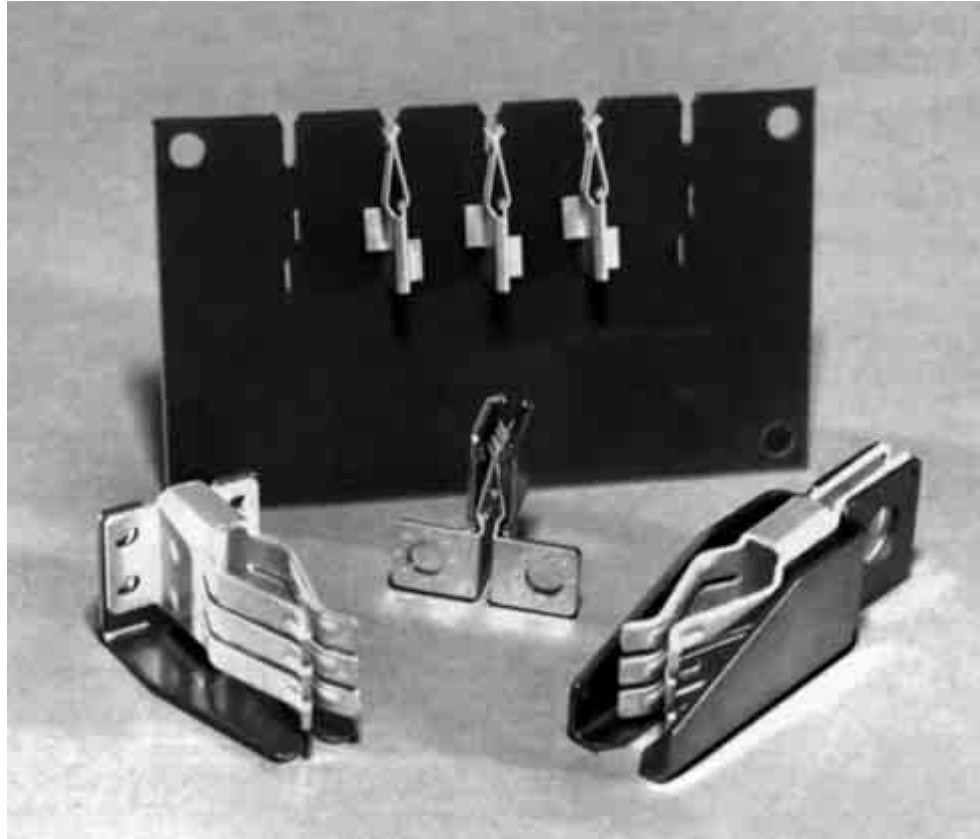

Technical Documents

Applications Specifications

Provide instructions for assembling or applying product

114-2130 062 Series
114-2111 125 Series

Product Specifications

108-1380 062 Series
108-1101 125 Series

The Tyco Electronics pluggable bus bar connectors are suitable for computer, industrial control and modular power supply applications that demand low millivolt drop and reliable separation. This unique connector design replaces the nuts and bolts previously used to transfer power from the source to the bus bar and simplifies power distribution.

The pluggable bus bar connectors mate with .125" [3.18] or .062" [1.57] thick plated bus bars providing a separable connection that eases assembly, inspection and trouble shooting. The silver-plated, high conductivity copper alloy contacts offer a low resistance contact resulting in low millivolt drop providing efficient power distribution.

These blind mateable connectors feature a generous lead-in on the integral stainless steel guide plate. This permits mating if the bus bar is slightly misaligned and provides anti-overstress protection for the contact.

Pluggable bus bar connectors can be mounted directly to a bus bar or fed by a power supply cable as outlined in the Application Specifications.

Pluggable Bus Bar Connectors (Continued)

125 Series

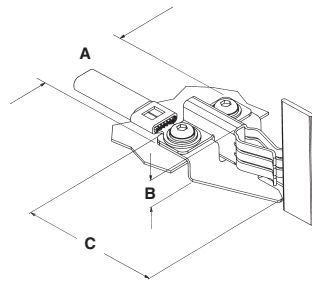

Style F

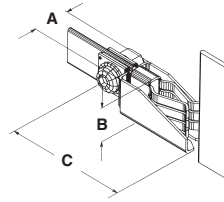

Style F2

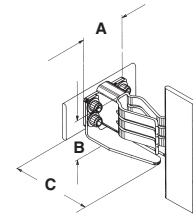

Style F3

Selection Data

Series	Style	Dimensions			Part Number
		"A" (Width)	"B" (Height)	"C" (Length)	
125 Series Fits Bus Bar .125 [3.18] Thick	F *	2.290 58.17	1.141 28.99	3.200 81.28	104502-1
	F2	.850 21.59	1.122 28.5	3.294 83.67	104501-1
	F3	1.250 31.75	1.141 28.99	1.993 50.61	213647-1

* Bus Bar or Cable Power Feed

062 Series

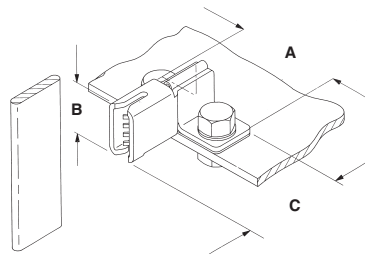

Style F

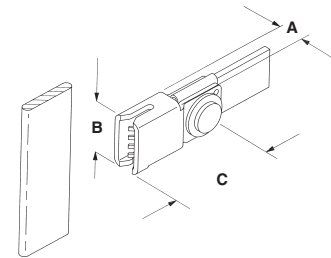

Style F2

Selection Data

Series	Style	Dimensions			Part Number
		"A" (Width)	"B" (Height)	"C" (Length)	
062 Series Fits Bus Bar .062 [1.57] Thick	F	1.360 34.54	.705 17.91	1.342 34.09	104729-1
	F2	.356 9.04	.705 17.91	1.342 34.09	104742-2

Note: All part numbers are RoHS compliant.

Pluggable Bus Bar Connectors (Continued)

Materials

Contact — Copper alloy, plated Silver over nickel

Guide Plate — Stainless steel

Specifications

Rated Current —

125 Series — Up to 500 amps at 30°C maximum t-rise *

062 Series — Up to 250 amps at 30°C maximum t-rise *

*actual current rating is dependent on bus bar/wire and ambient conditions (see charts).

Contact Resistance —

125 Series — 10 milliohms maximum

062 Series — 50 milliohms maximum

Mating Force —

125 Series — 30 lb. [133.4 N] maximum

062 Series — 6 lb. [26.7 N] maximum

Unmating Force —

125 and 062 Series — 1 lb. [4.4 N] minimum

Durability —

125 Series — 100 cycle minimum

062 Series — 50 cycle minimum

125 Series

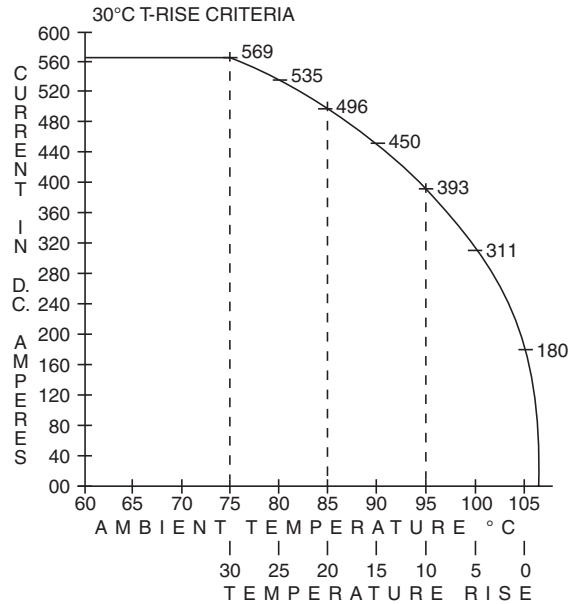

Current Carrying Capability

Test Configuration	Multiplication Factor
Contact on 4x12 [101.6 x 304.8] bar mated with 4x12 [101.6 x 304.8] bar	1.00
Contact on 1x12 [25.4 x 304.8] bar mated with 1x23 [25.4 x 584.2] bar	0.40
Contact on AWG #00 mated with 1x12 [25.4 x 304.8] bar	0.38
Contact on AWG #2 mated with 1x12 [25.4 x 304.8] bar	0.32

062 Series

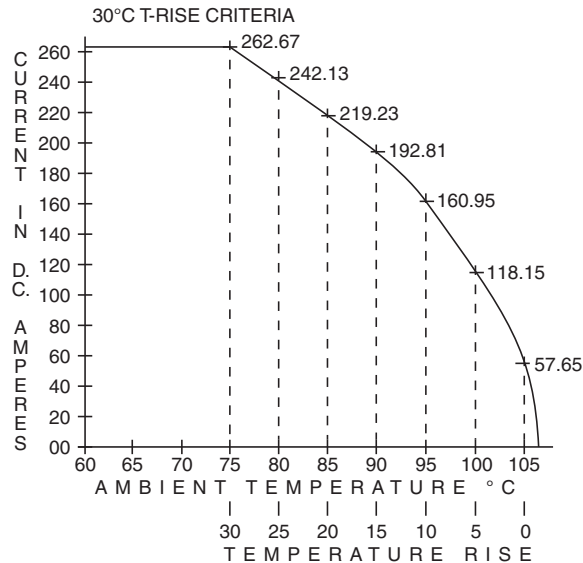

Current Carrying Capability

Test Configuration	Multiplication Factor
Contact on 1.5 x 6 [38.1 x 304.8] Bar mated with 1.5 x 12 [38.1 x 304.8] Bar	1.00
Contact on 1.0 x 6 [25.4 x 304.8] Bar mated with 1.0 x 12 [25.4 x 304.8] Bar	0.81
Contact on 0.5 x 6 [12.7 x 304.8] Bar mated with 0.5 x 12 [12.7 x 304.8] Bar	0.58

CROWN LINE Power Distribution System

Product Facts

- Currents up to 250 A
- Up to 2 Meters in Length
- Pluggable Breakers
- VDE Finger proof
- Flammability UL 94 V-0
- Easily Configurable
- Adaptable
- Space Efficient
- Reduced Cable
- Reduced Installation Costs
- Polarized Connector Fitting
- Left and Right Handed

Applications

- Power Distribution
- Core Network Equipment
- Cellular Base Stations
- Servers, Storage & Network Routers
- Industrial

Technical Documents

Product Specification

108-19299

Application Specification

114-19108



The CROWN LINE system is designed for cost effective power distribution in equipment cabinets, telecoms base stations, computer servers, storage systems and industrial applications.

The unique finger proof design is designed to reduce assembly time, give repeatable low impedance electrical performance and reduce wiring errors with pre-determined input/output connections. System thermal characteristics are improved with the use of flat copper conductors allowing better airflow and

reducing current skin effects compared to conventional use of large AWG cables.

The CROWN LINE system consists of an extruded profile holding two solid copper conductors. Power is supplied to conductors from a regulated power source using flexible power cables and color coded RAPID LOCK right-angle sockets. The option to vary conductor thickness provides a flexible and adaptable design up to 2 meters in length with the ability to preform conductors to fit into awkward spaces.

Power input and output connectors use proven CROWN BAND and CROWN CLIP contact systems for reliable, low loss connections.

A connector with or without a circuit breaker, can be mated direct to the CROWN LINE System at any location along its length. The circuit breaker connector (CBC) accepts industry standard circuit breakers with tab terminals. A positive lock cable assembly connects from the CBC to deliver power where needed.

CROWN LINE Power Distribution System (Continued)

Bus Bar Products

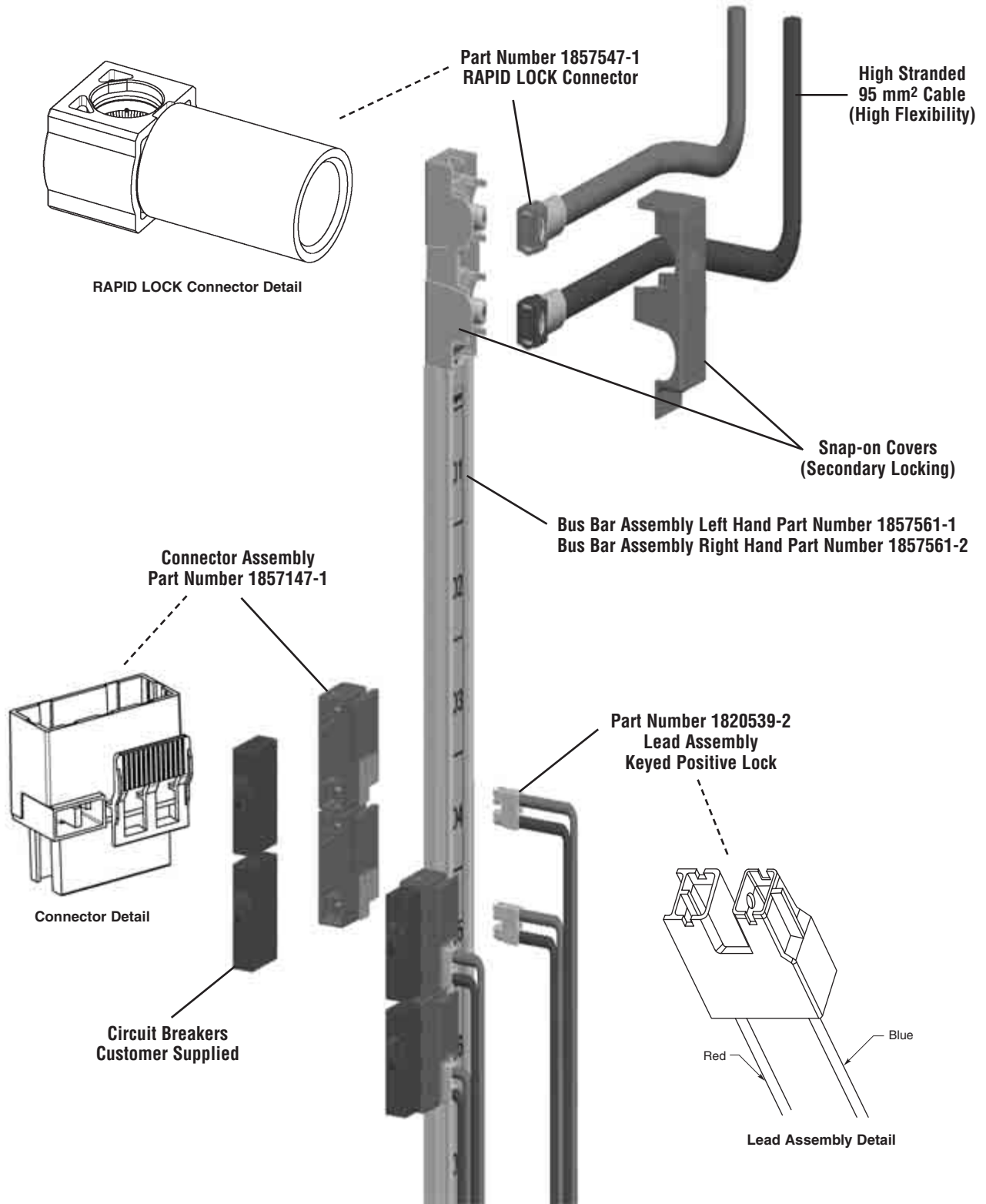

Note: All part numbers are RoHS compliant.