

**Product number F13659_ANGELINA-S-B**

Family	Angelina	FWHM	(simulated) 22
Type	Reflector	Efficiency	(simulated) 95 %
LED	CLL04x/CLU04x	cd/lm	(simulated) 3.100
Color	Metal	Gerber File	Available
Diameter	82 mm		
Height	31 mm		
Style	Round		
Optic Material	PC		
Holder Material	-		
Fastening	""		
Status	Production ready		

Product number F13660_ANGELINA-M-B

Family	Angelina	FWHM	(simulated) 37
Type	Reflector	Efficiency	(simulated) 95 %
LED	CLL04x/CLU04x	cd/lm	(simulated) 1.600
Color	Metal	Gerber File	Available
Diameter	82 mm		
Height	31 mm		
Style	Round		
Optic Material	PC		
Holder Material	-		
Fastening	""		
Status	Production ready		

Product number F13661_ANGELINA-W-B

Family	Angelina	FWHM	(simulated) 52
Type	Reflector	Efficiency	(simulated) 95 %
LED	CLL04x/CLU04x	cd/lm	(simulated) 1.100
Color	Metal	Gerber File	Available
Diameter	82 mm		
Height	31 mm		
Style	Round		
Optic Material	PC		
Holder Material	-		
Fastening	""		
Status	Production ready		

Product number F13661_ANGELINA-W-B

Family	Angelina	FWHM	(simulated) 55
Type	Reflector	Efficiency	(simulated) 90 %
LED	CLL04x/CLU04x	cd/lm	(simulated) 0.940
Color	Metal	Gerber File	Available
Diameter	82 mm		
Height	31 mm		
Style	Round		
Optic Material	PC		
Holder Material	-		
Fastening	""		
Status	Production ready		

**Product number F13325_ANGELINA-S**

Family	Angelina	FWHM	29 degrees
Type	Reflector	Efficiency	93 %
LED	CLL04x/CLU04x	cd/lm	1.700
Color	Metal	Gerber File	Available
Diameter	82 mm		
Height	31 mm		
Style	Round		
Optic Material	PC		
Holder Material	-		
Fastening	""		
Status	Production ready		

**Product number FCN13691_ANGELINA-S**

Family	Angelina	FWHM	29 degrees
Type	RefPack	Efficiency	93 %
LED	CLL04x/CLU04x	cd/lm	1.700
Color	Metal	Gerber File	Available
Diameter	82 mm		
Height	36.04 mm		
Style	Round		
Optic Material	-		
Holder Material	-		
Fastening	""		
Status	Production ready		

**Product number F13325_ANGELINA-S**

Family	Angelina	FWHM	30 degrees
Type	Reflector	Efficiency	92 %
LED	CLL04x/CLU04x	cd/lm	1.600
Color	Metal	Gerber File	Available
Diameter	82 mm		
Height	31 mm		
Style	Round		
Optic Material	PC		
Holder Material	-		
Fastening	""		
Status	Production ready		

**Product number F13659_ANGELINA-S-B**

Family	Angelina	FWHM	30 degrees
Type	Reflector	Efficiency	92 %
LED	CLL04x/CLU04x	cd/lm	1.600
Color	Metal	Gerber File	Available
Diameter	82 mm		
Height	31 mm		
Style	Round		
Optic Material	PC		
Holder Material	-		
Fastening	""		
Status	Production ready		

**Product number F13659_ANGELINA-S-B**

Family	Angelina	FWHM	33 degrees
Type	Reflector	Efficiency	88 %
LED	CLL04x/CLU04x	cd/lm	1.390
Color	Metal	Gerber File	Available
Diameter	82 mm		
Height	31 mm		
Style	Round		
Optic Material	PC		
Holder Material	-		
Fastening	""		
Status	Production ready		

Product number FC13977_ANGELINA-RZ-S-B

Family	Angelina	FWHM	33 degrees
Type	RefPack	Efficiency	88 %
LED	CLL04x/CLU04x	cd/lm	1.390
Color	Metal	Gerber File	Available
Diameter	82 mm		
Height	31 mm		
Style	Round		
Optic Material	PC		
Holder Material	-		
Fastening	["screw", "socket"]		
Status	Production ready		

For BJB connectors

Product number F13660_ANGELINA-M-B

Family	Angelina	FWHM	39 degrees
Type	Reflector	Efficiency	94 %
LED	CLL04x/CLU04x	cd/lm	1.200
Color	Metal	Gerber File	Available
Diameter	82 mm		
Height	31 mm		
Style	Round		
Optic Material	PC		
Holder Material	-		
Fastening	""		
Status	Production ready		

Product number F13401_ANGELINA-M

Family	Angelina	FWHM	42 degrees
Type	Reflector	Efficiency	92 %
LED	CLL04x/CLU04x	cd/lm	1.100
Color	Metal	Gerber File	Available
Diameter	82 mm		
Height	31 mm		
Style	Round		
Optic Material	PC		
Holder Material	-		
Fastening	""		
Status	Production ready		

**Product number FCN13692_ANGELINA-M**

Family	Angelina	FWHM	42 degrees
Type	RefPack	Efficiency	92 %
LED	CLL04x/CLU04x	cd/lm	1.100
Color	Metal	Gerber File	Available
Diameter	82 mm		
Height	36.04 mm		
Style	Round		
Optic Material	-		
Holder Material	-		
Fastening	""		
Status	Production ready		

Product number F13401_ANGELINA-M

Family	Angelina	FWHM	43 degrees
Type	Reflector	Efficiency	91 %
LED	CLL04x/CLU04x	cd/lm	1.100
Color	Metal	Gerber File	Available
Diameter	82 mm		
Height	31 mm		
Style	Round		
Optic Material	PC		
Holder Material	-		
Fastening	""		
Status	Production ready		

Product number F13402_ANGELINA-W

Family	Angelina	FWHM	43 degrees
Type	Reflector	Efficiency	91 %
LED	CLL04x/CLU04x	cd/lm	1.100
Color	Metal	Gerber File	Available
Diameter	82 mm		
Height	31 mm		
Style	Round		
Optic Material	PC		
Holder Material	-		
Fastening	""		
Status	Production ready		

Product number F13660_ANGELINA-M-B

Family	Angelina	FWHM	50 degrees
Type	Reflector	Efficiency	87 %
LED	CLL04x/CLU04x	cd/lm	0.920
Color	Metal	Gerber File	Available
Diameter	82 mm		
Height	31 mm		
Style	Round		
Optic Material	PC		
Holder Material	-		
Fastening	""		
Status	Production ready		

**Product number FC13978_ANGELINA-RZ-M-B**

Family	Angelina	FWHM	50 degrees
Type	RefPack	Efficiency	87 %
LED	CLL04x/CLU04x	cd/lm	0.920
Color	Metal	Gerber File	Available
Diameter	82 mm	For BJB connectors	
Height	31 mm		
Style	Round		
Optic Material	PC		
Holder Material	-		
Fastening	["screw", "socket"]		
Status	Production ready		

**Product number F13402_ANGELINA-W**

Family	Angelina	FWHM	54 degrees
Type	Reflector	Efficiency	92 %
LED	CLL04x/CLU04x	cd/lm	0.960
Color	Metal	Gerber File	Available
Diameter	82 mm		
Height	31 mm		
Style	Round		
Optic Material	PC		
Holder Material	-		
Fastening	""		
Status	Production ready		

**Product number FCN13693_ANGELINA-W**

Family	Angelina	FWHM	54 degrees
Type	RefPack	Efficiency	92 %
LED	CLL04x/CLU04x	cd/lm	0.960
Color	Metal	Gerber File	Available
Diameter	82 mm		
Height	36 mm		
Style	Round		
Optic Material	-		
Holder Material	-		
Fastening	""		
Status	Production ready		

**Product number F13661_ANGELINA-W-B**

Family	Angelina	FWHM	62 degrees
Type	Reflector	Efficiency	92 %
LED	CLL04x/CLU04x	cd/lm	0.820
Color	Metal	Gerber File	Available
Diameter	82 mm		
Height	31 mm		
Style	Round		
Optic Material	PC		
Holder Material	-		
Fastening	""		
Status	Production ready		

**Product number F13661_ANGELINA-W-B**

Family	Angelina	FWHM	66 degrees
Type	Reflector	Efficiency	87 %
LED	CLL04x/CLU04x	cd/lm	0.730
Color	Metal	Gerber File	Available
Diameter	82 mm		
Height	31 mm		
Style	Round		
Optic Material	PC		
Holder Material	-		
Fastening	""		
Status	Production ready		

**Product number FC13979_ANGELINA-RZ-W-B**

Family	Angelina	FWHM	66 degrees
Type	RefPack	Efficiency	87 %
LED	CLL04x/CLU04x	cd/lm	0.730
Color	Metal	Gerber File	Available
Diameter	82 mm		
Height	31 mm		
Style	Round		
Optic Material	PC		
Holder Material	-		
Fastening	["socket", "screw"]		
Status	Production ready		

For BJB connectors

**Product number F13838_ANGELINA-XW**

Family	Angelina	FWHM	88 degrees
Type	Reflector	Efficiency	95 %
LED	CLL04x/CLU04x	cd/lm	0.510
Color	White	Gerber File	Available
Diameter	82 mm		
Height	31 mm		
Style	Round		
Optic Material	HRPC		
Holder Material	-		
Fastening	""		
Status	Production ready		

**Product number FCN13912_ANGELINA-XW**

Family	Angelina	FWHM	88 degrees
Type	RefPack	Efficiency	95 %
LED	CLL04x/CLU04x	cd/lm	0.510
Color	White	Gerber File	Available
Diameter	-		
Height	-		
Style	Round		
Optic Material	-		
Holder Material	-		
Fastening	["screw"]		
Status	Production ready		

Product number F13839_ANGELINA-XW-B

Family	Angelina	FWHM	91 degrees
Type	Reflector	Efficiency	94 %
LED	CLL04x/CLU04x	cd/lm	0.500
Color	White	Gerber File	Available
Diameter	82 mm		
Height	31 mm		
Style	Round		
Optic Material	HRPC		
Holder Material	-		
Fastening	-		
Status	Production ready		

Product number F13839_ANGELINA-XW-B

Family	Angelina	FWHM	91 degrees
Type	Reflector	Efficiency	88 %
LED	CLL04x/CLU04x	cd/lm	0.450
Color	White	Gerber File	Available
Diameter	82 mm		
Height	31 mm		
Style	Round		
Optic Material	HRPC		
Holder Material	-		
Fastening	-		
Status	Production ready		

Product number FC13982_ANGELINA-RZ-XW-B

Family	Angelina	FWHM	91 degrees
Type	RefPack	Efficiency	88 %
LED	CLL04x/CLU04x	cd/lm	0.450
Color	White	Gerber File	Available
Diameter	82 mm		
Height	31 mm		
Style	Round		
Optic Material	HRPC		
Holder Material	-		
Fastening	["screw", "socket"]		
Status	Production ready		

For BJB connector 47.319.2030

Product number F13839_ANGELINA-XW-B

Family	Angelina	FWHM	92 degrees
Type	Reflector	Efficiency	94 %
LED	CLL04x/CLU04x	cd/lm	0.480
Color	White	Gerber File	Available
Diameter	82 mm		
Height	31 mm		
Style	Round		
Optic Material	HRPC		
Holder Material	-		
Fastening	-		
Status	Production ready		



PRODUCT DATASHEET

Angelina series

last update 16/1/2015

NOTE: The typical divergence will be changed by different color, chip size and chip position tolerance. The typical total divergence is the full angle measured where the luminous intensity is half of the peak value.

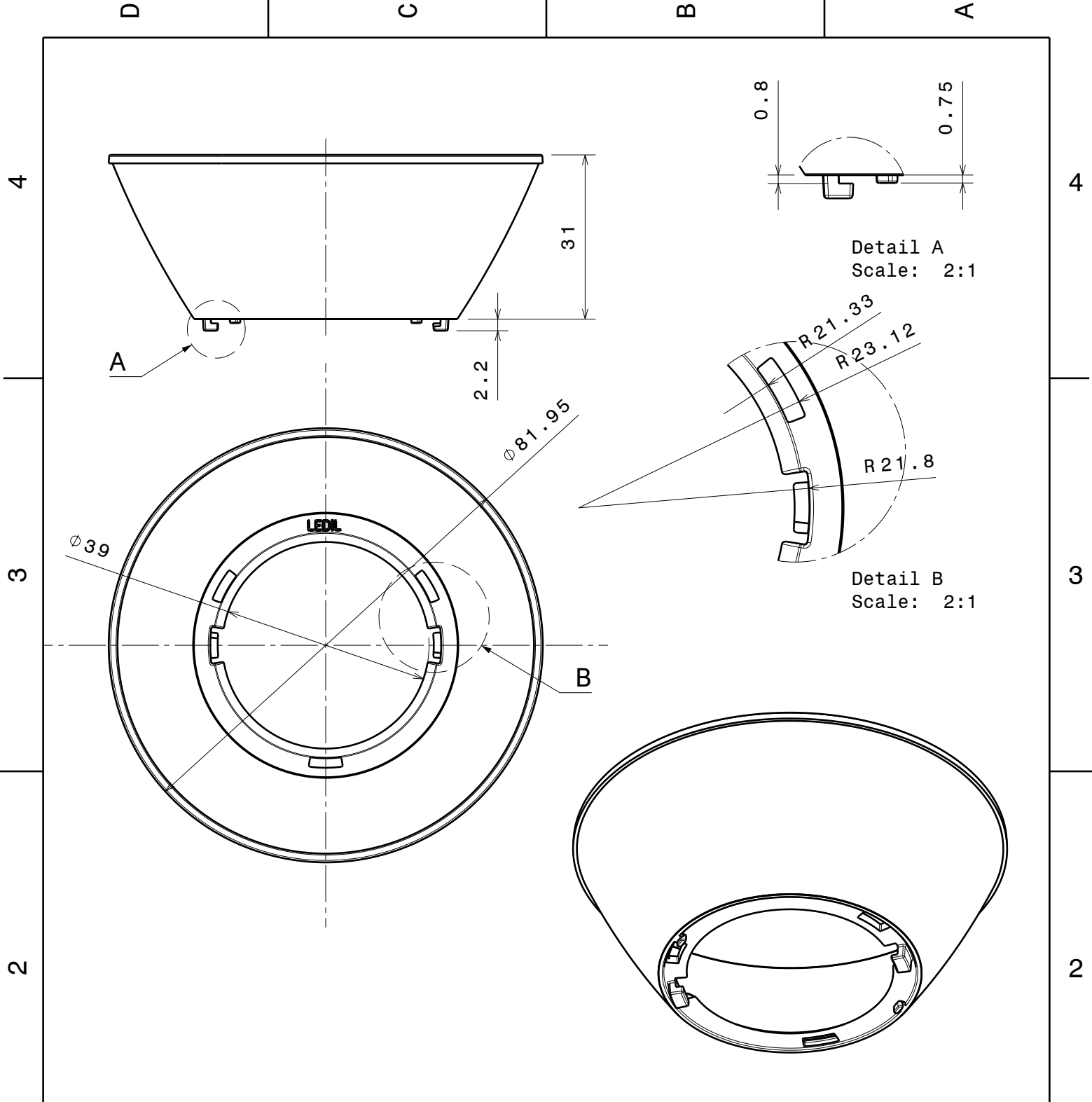

INDEX	PART NO	DESCRIPTION	MATERIAL	COLOUR
1		ANGELINA-B	PC	metal

Tolerances if not otherwise shown
 According to DIN ISO 2768-1
 Linear measures:
 Up to 30mm class M, otherwise class C.
 According to DIN ISO 2768-2
 Form and position: class L

LEDiL Ledil Oy
 Salorankatu 10
 FIN 24240 SALO
 Finland

THIRD ANGLE PROJECTION:

DRAWING TITLE
ANGELINA-B series Reflector

This drawing is the property of LEDiL Oy. It may not be reproduced, copied or communicated without a written agreement with LEDiL Oy."

SIZE PART NUMBER
A4 -

SCALE 1:1 WEIGHT - SHEET 1/1

Luminaire: Ledil Oy F13661_ANGELINA-W-B_(CLU048)_(47_319_2030)_SIMULATED
Lamps: 1 x Citizen CLU048 (CLU048-1212C4-303M2K1) + BJB connector 47.319.2030

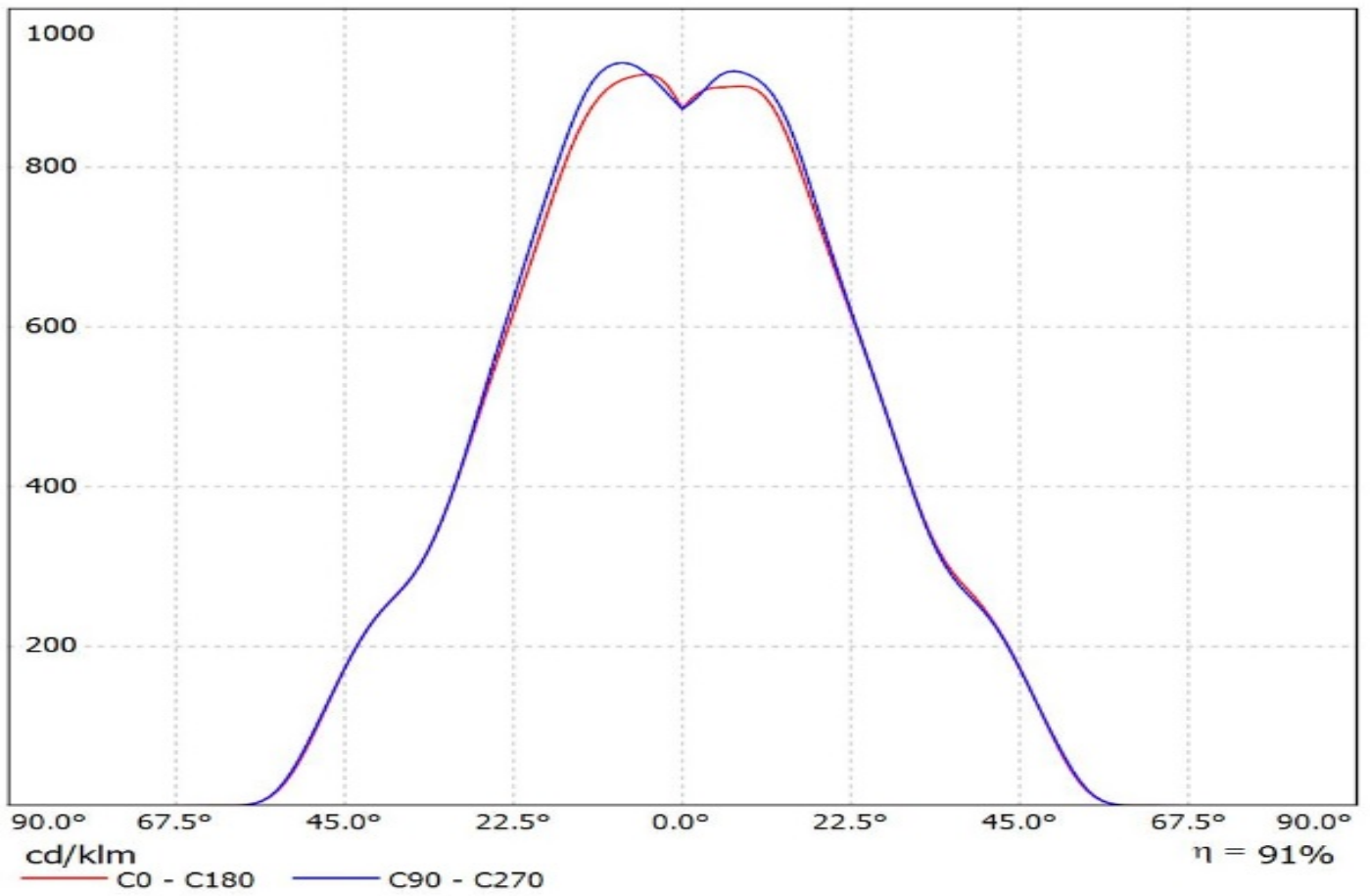

Luminaire: Ledil FCN13691_ANGELINA-S_(CLU044)_ (431_Typ_L3)

Lamps: 1 x Citizen_CLU044_(CLU044-1212B8-303M1A2)_1272.54lm@250mA_P=8.16W_I=0.25A

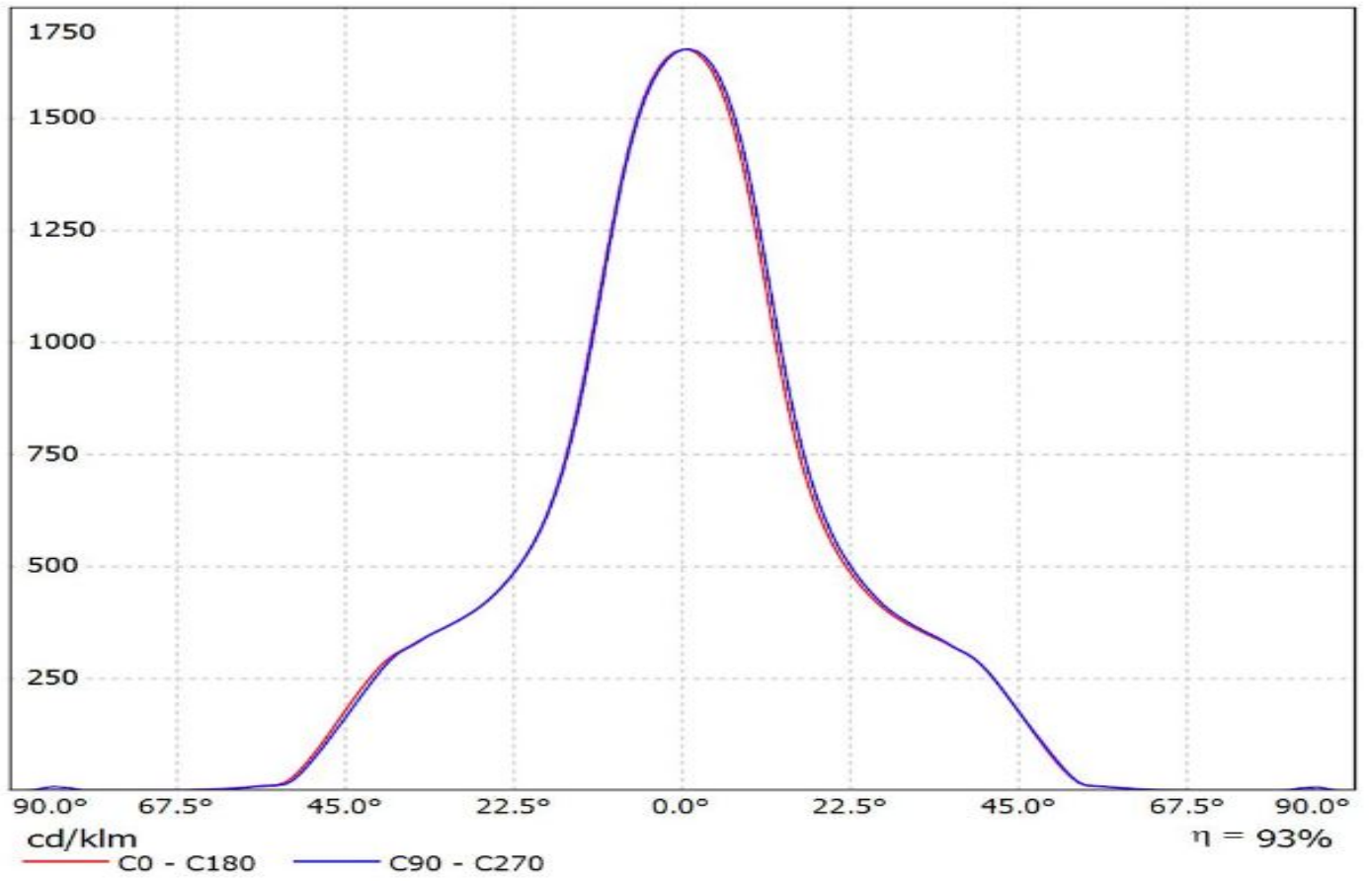

Luminaire: Ledil F13325_ANGELINA-S_(CLU046+IDEAL)

Lamps: 1 x Citizen_CLU046_(-1212C1-303M2G2)_1383.92lm@250mA_CCT=3000K_P=8.122W_I=0.25A

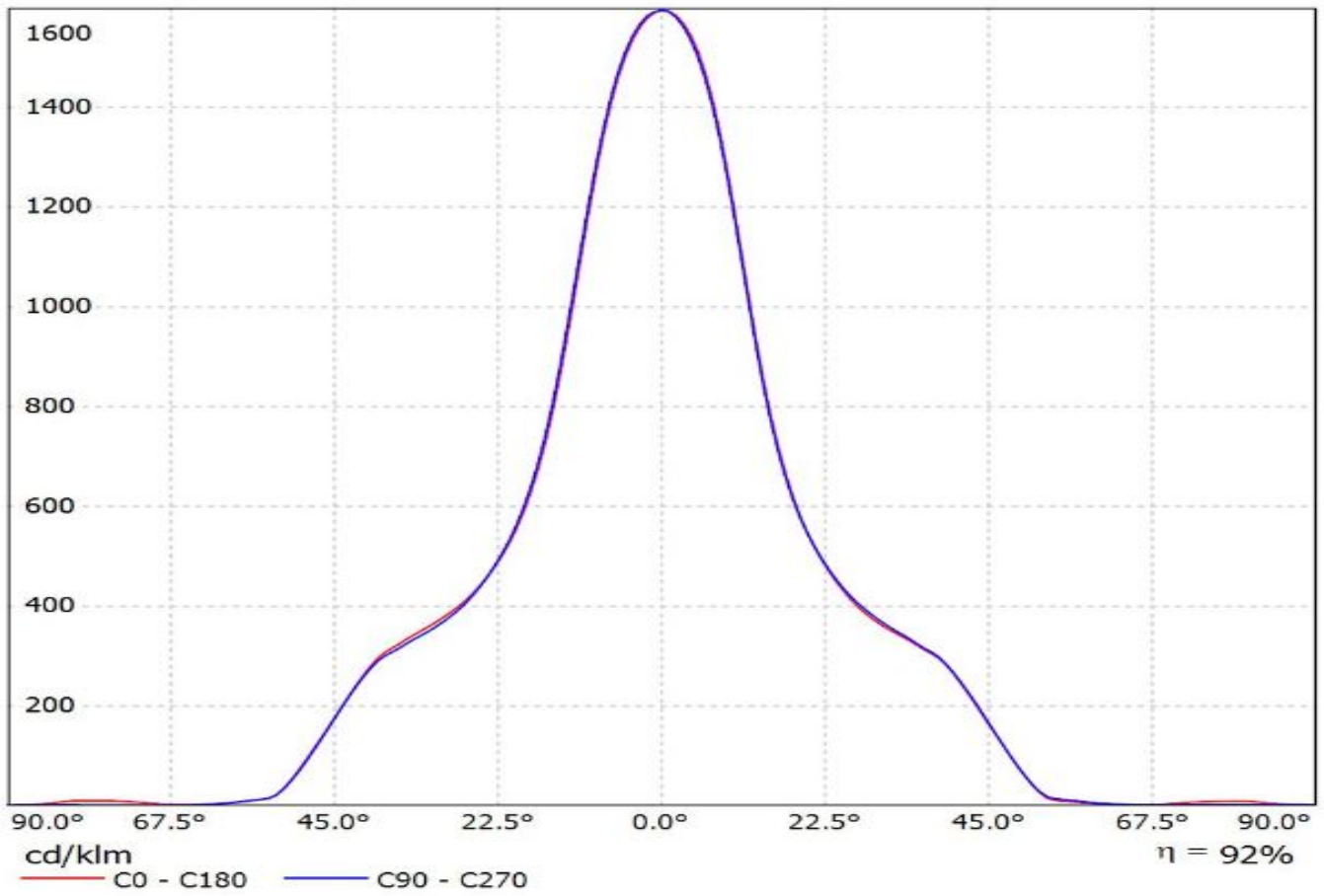

Luminaire: LEDiL Oy F13659_ANGELINA-S-B_(CLU044)

Lamps: 1 x Citizen_CLU044_(CLU044-1212B8-303M1A2)_1300.9lm@250mA_P=8.14849W_I=249.9mA

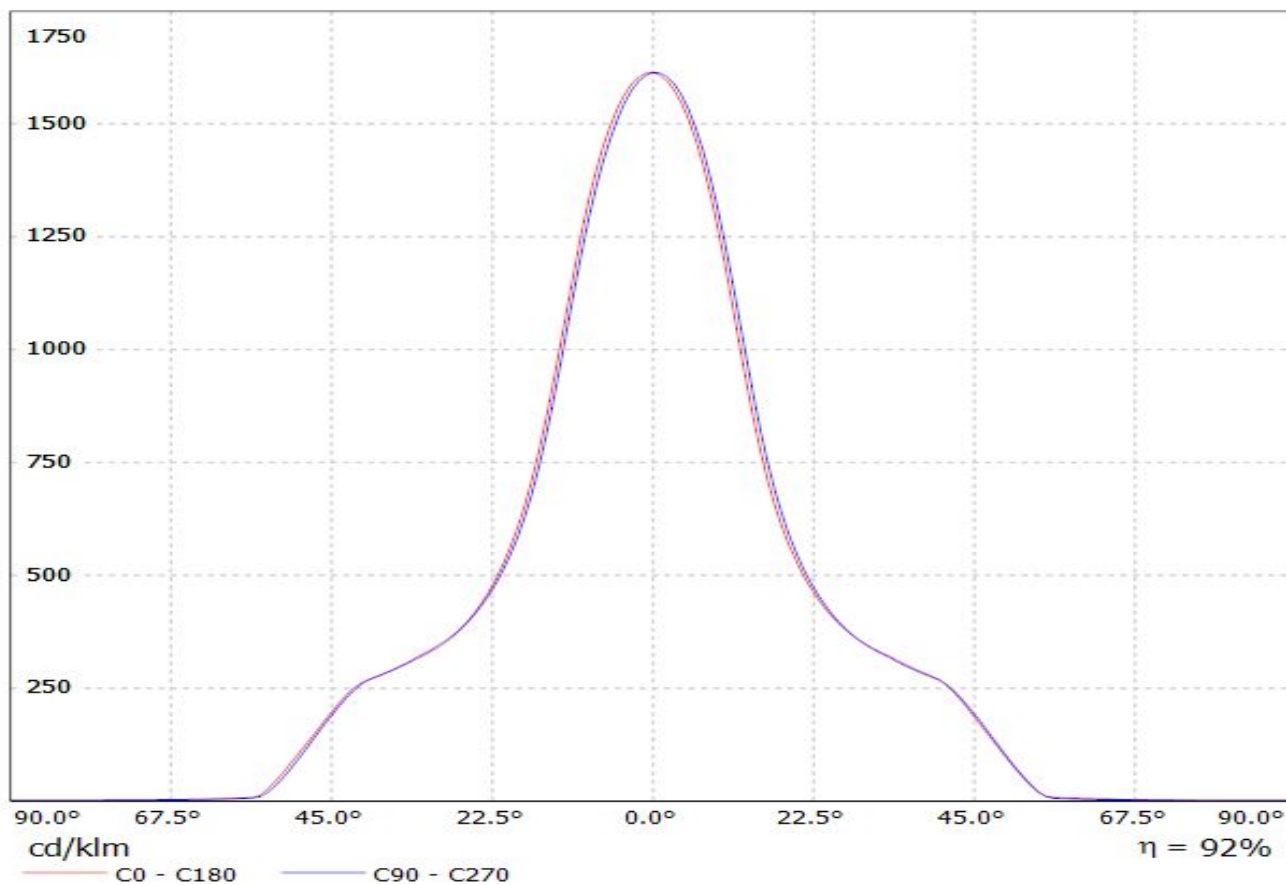

Luminaire: LEDiL Oy FC13977_ANGELINA-RZ-S-B_(CLU044)_+(Stucchi_8102-G2)
Lamps: 1 x Citizen_CLU044_(1212B8-303M1A2)_+(Stucchi_8102/G2)_1291.68lm@250mA_P=8.13748W_I=0.250A

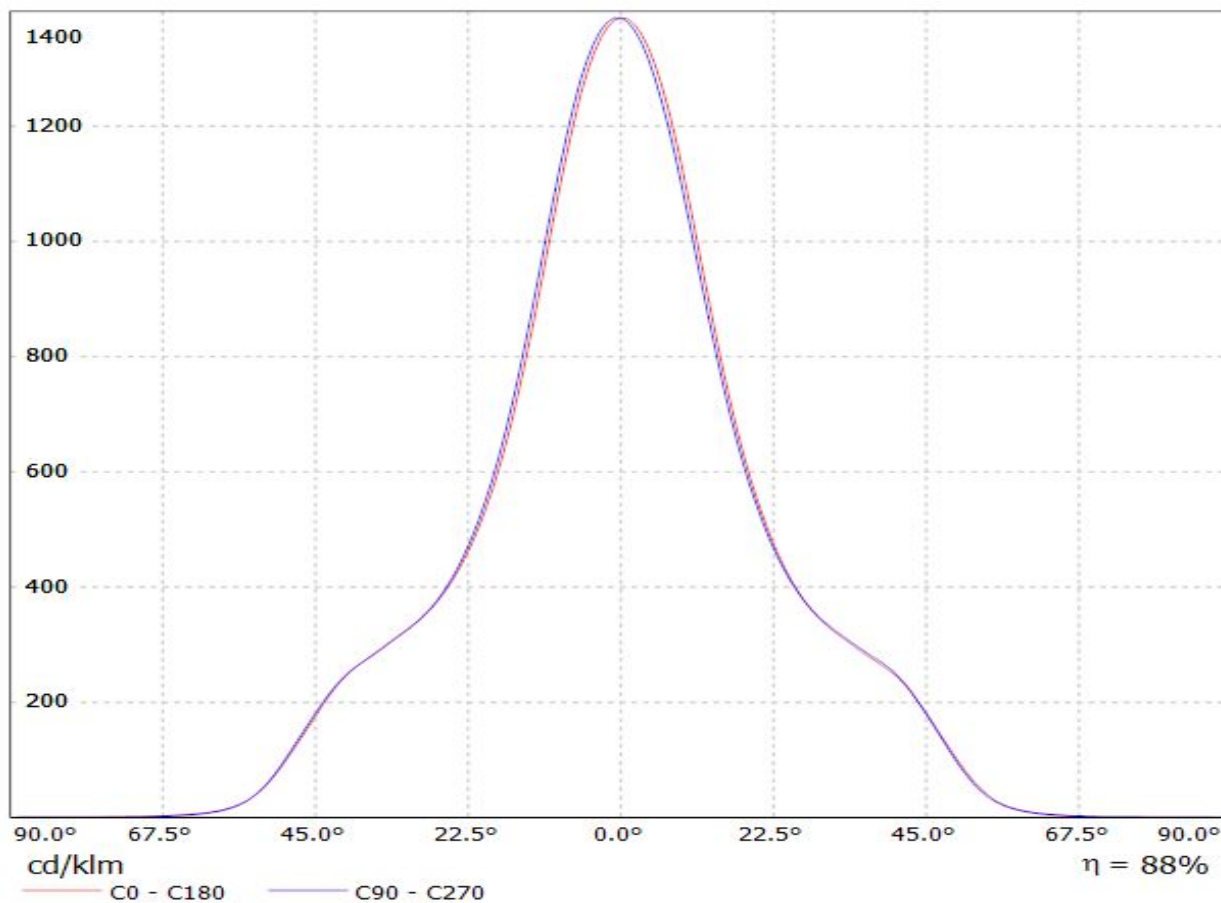

Luminaire: LEDiL Oy F13660_ANGELINA-M-B_(CLU044)

Lamps: 1 x Citizen_CLU044_(CLU044-1212B8-303M1A2)_1300.9lm@250mA_P=8.14849W_I=249.9mA

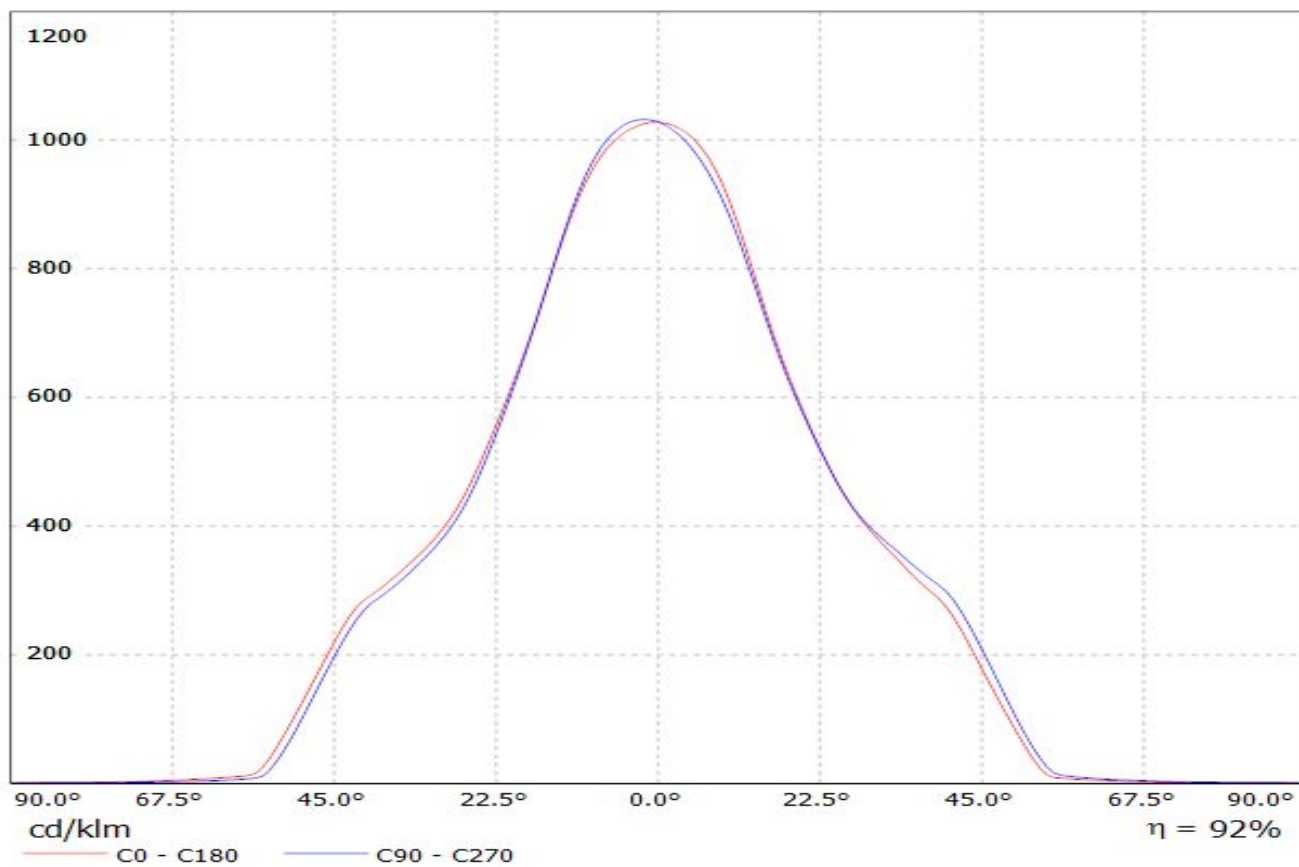

Luminaire: Ledil FCN13692_ANGELINA-M_(CLU044)_ (431_Typ_L3)

Lamps: 1 x Citizen_CLU044_(CLU044-1212B8-303M1A2)_1272.54lm@250mA_P=8.16W_I=0.25A

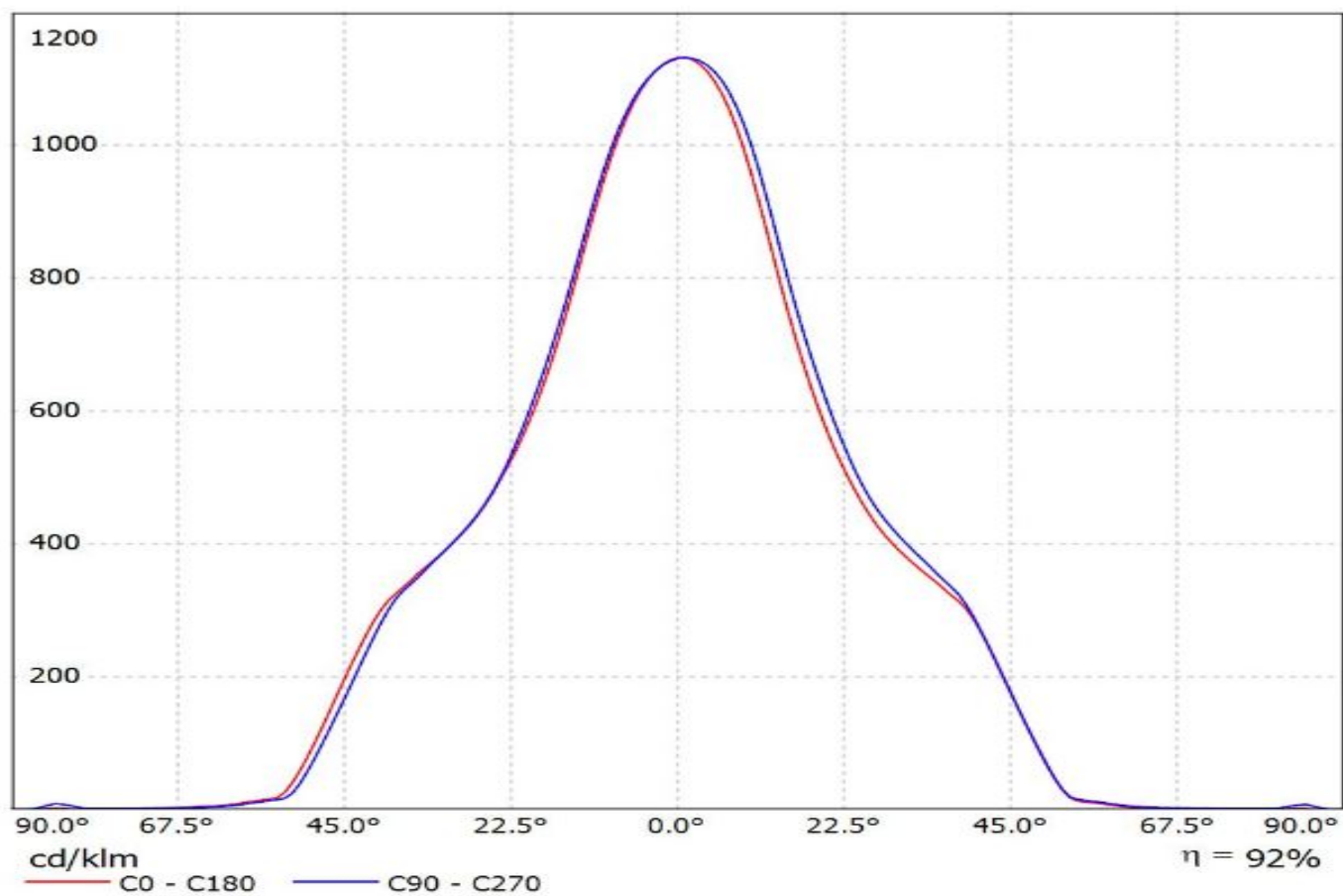

Luminaire: Ledil F13401_ANGELINA-M_(CLU046+IDEAL)

Lamps: 1 x Citizen_CLU046_(-1212C1-303M2G2)_1383.92lm@250mA_CCT=3000K_P=8.122W_I=0.25A

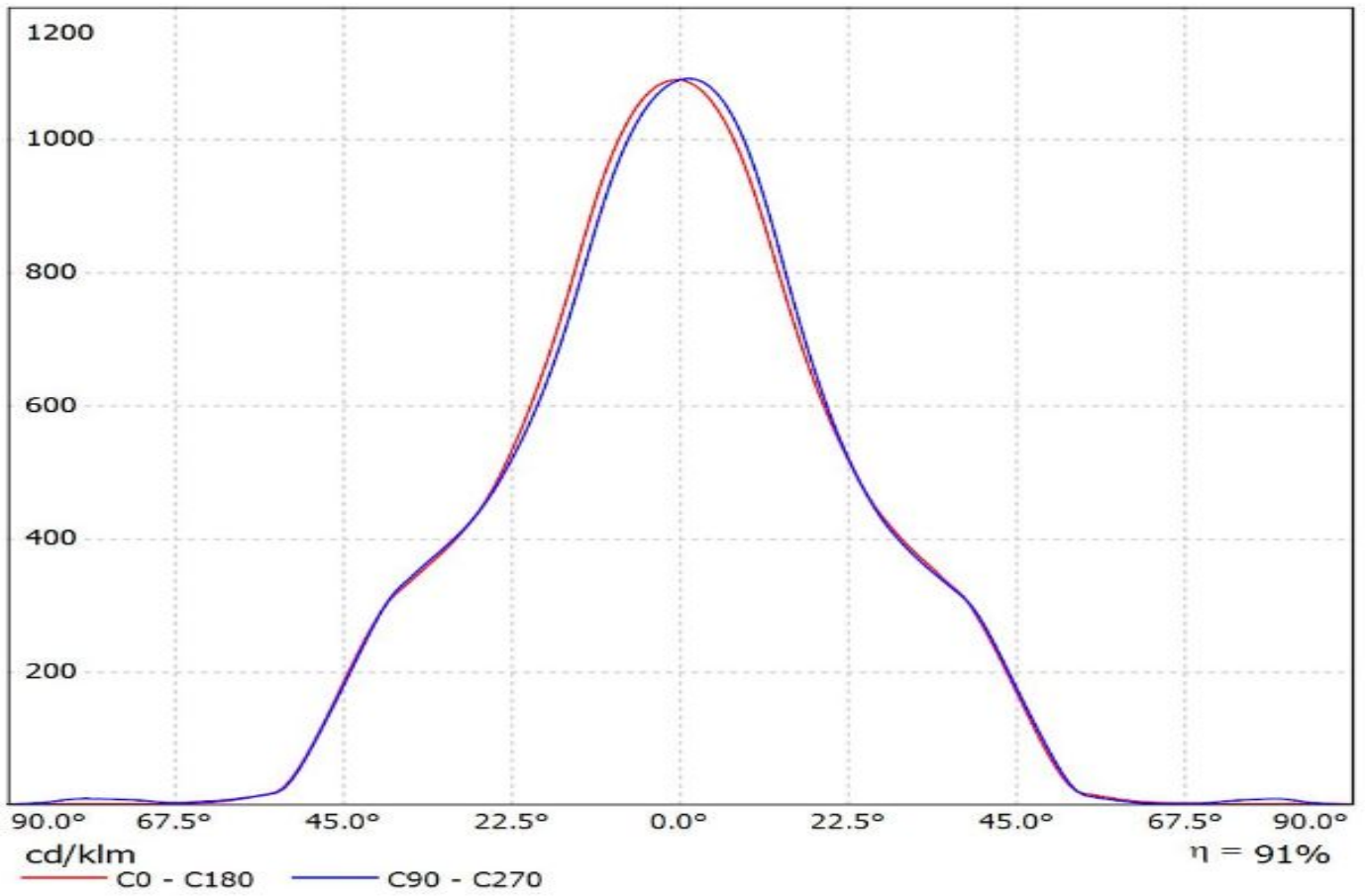

Luminaire: Ledil F13402_ANGELINA-W_(CLU046+IDEAL)

Lamps: 1 x Citizen_CLU046_(-1212C1-303M2G2)_1383.92lm@250mA_CCT=3000K_P=8.122W_I=0.25A

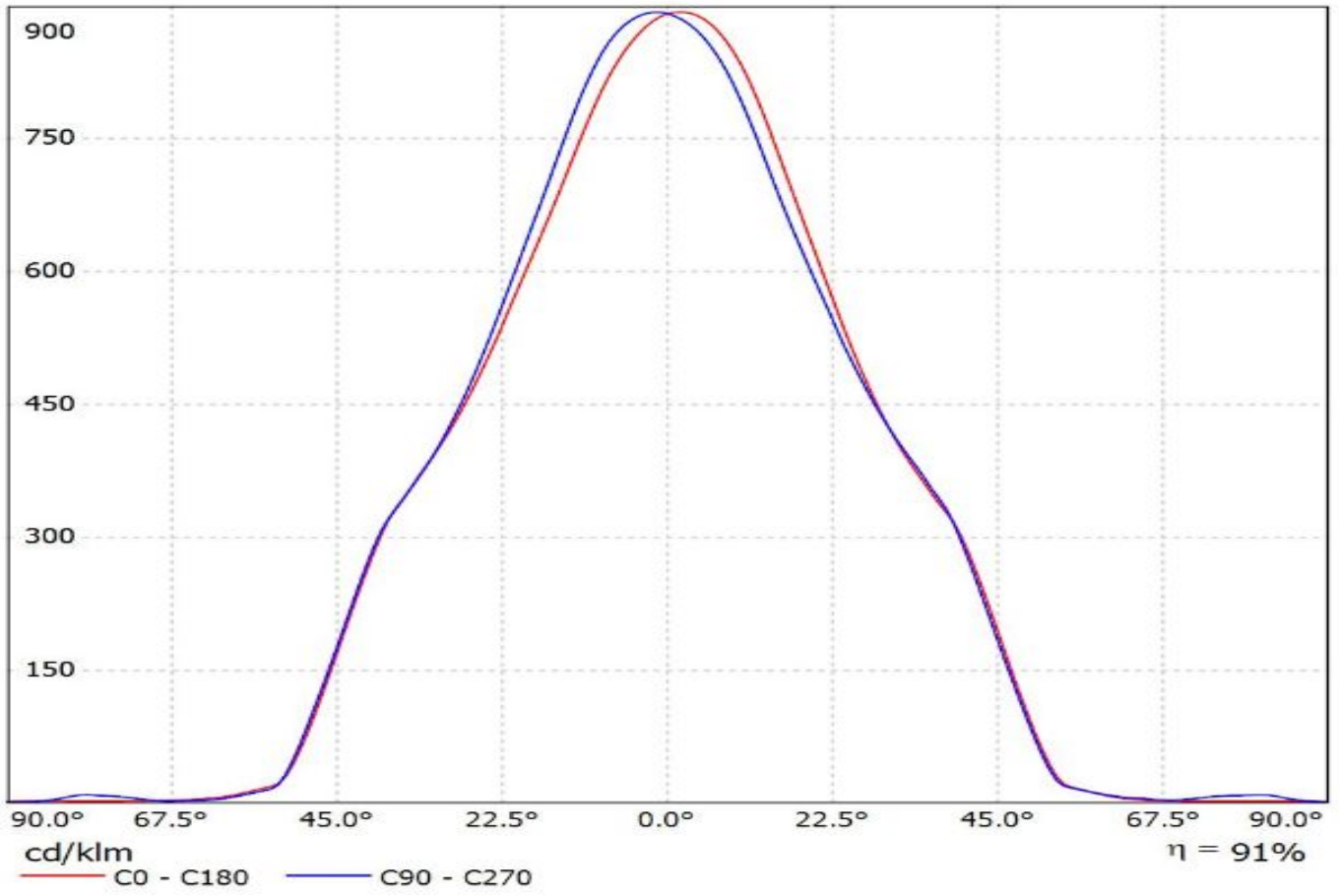

Luminaire: LEDiL Oy FC13978_ANGELINA-RZ-M-B_(CLU044)_+_ (Stucchi_8102-G2)
Lamps: 1 x Citizen_CLU044_(1212B8-303M1A2)_+_ (Stucchi_8102/G2)_1291.68lm@250mA_P=8.13748W_I=0.250A

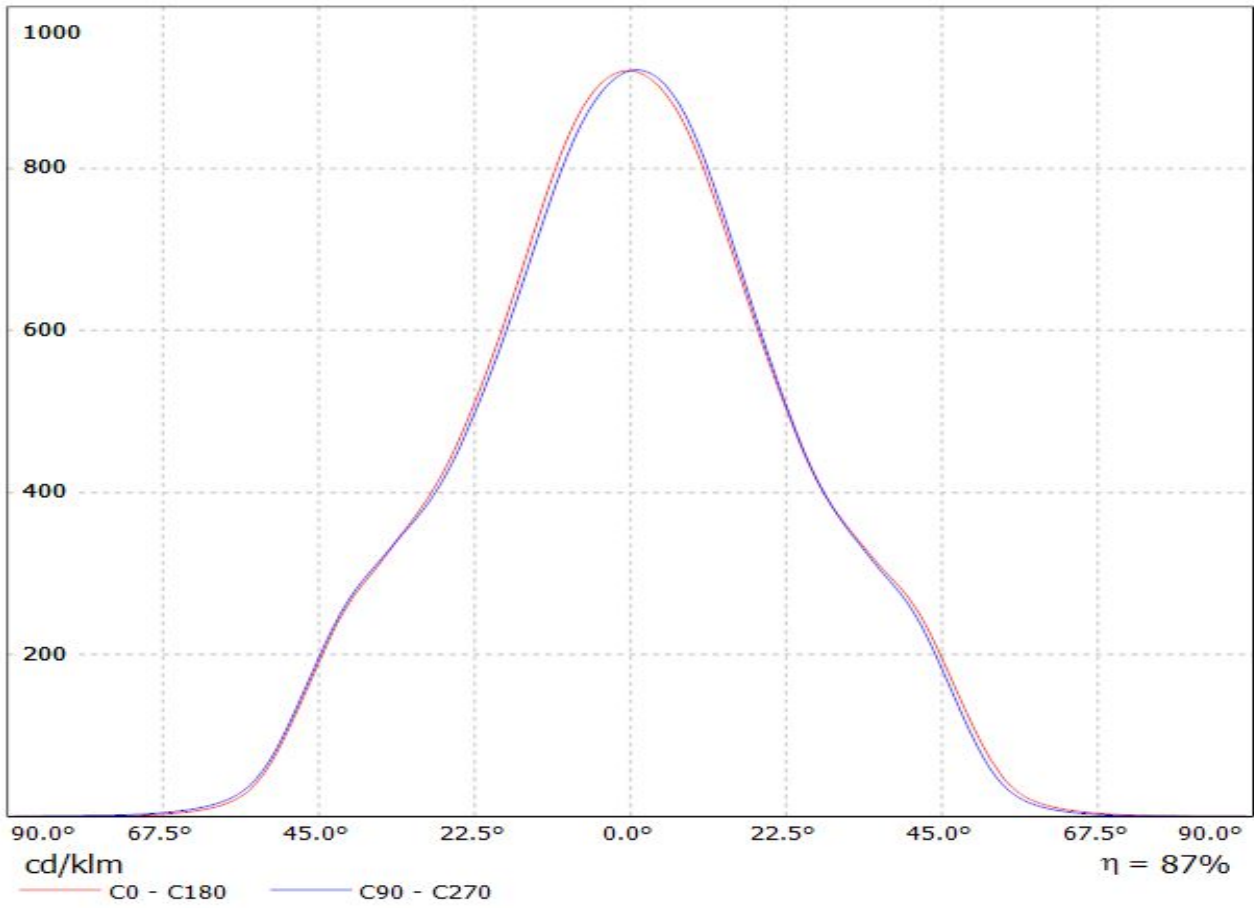

Luminaire: Ledil FCN13693_ANGELINA-W_(CLU044)_(431_Typ_L3)

Lamps: 1 x Citizen_CLU044_(CLU044-1212B8-303M1A2)_1272.54lm@250mA_P=8.16W_I=0.25A

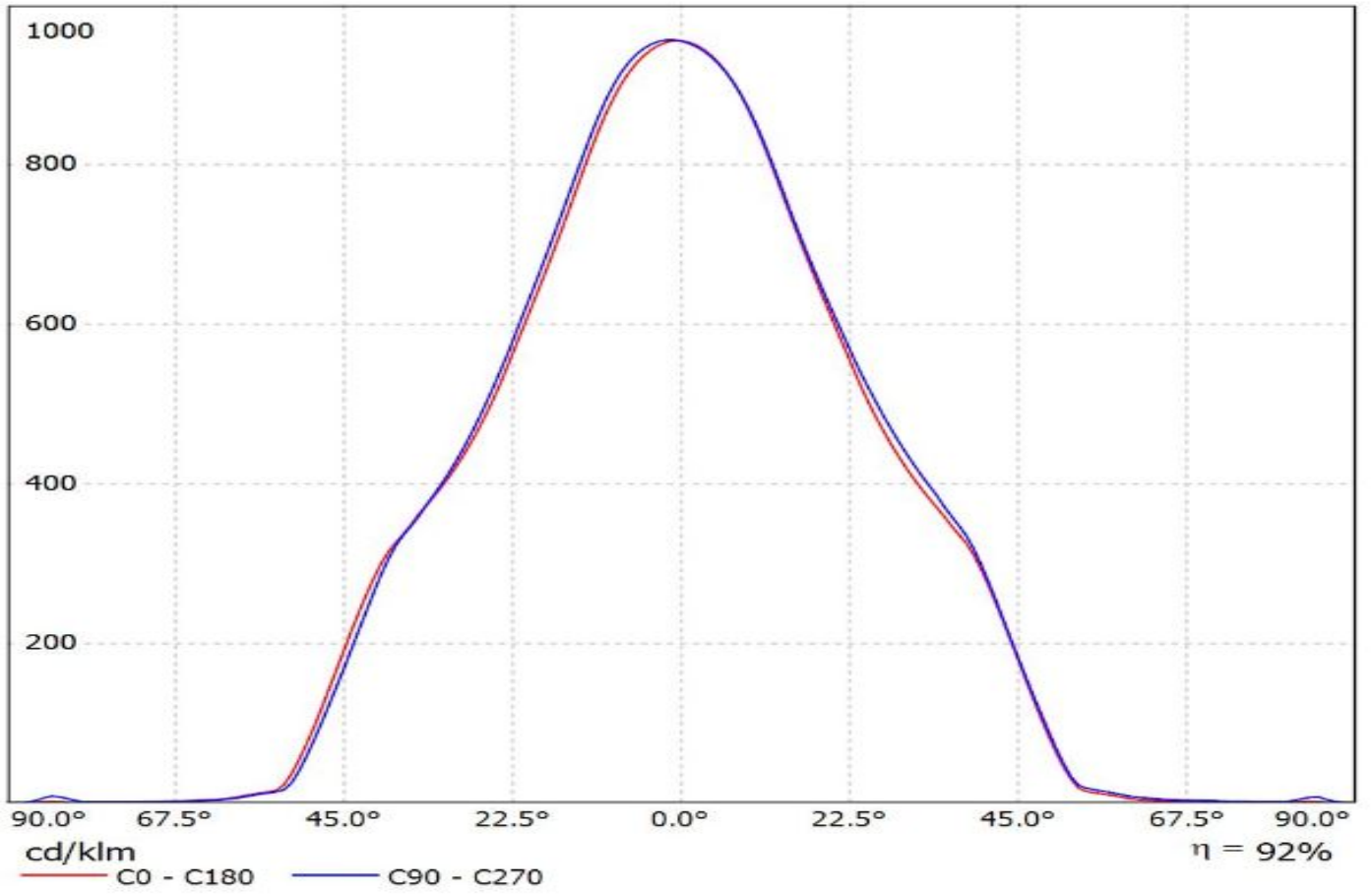

Luminaire: LEDiL Oy F13661_ANGELINA-W-B_(CLU044)

Lamps: 1 x Citizen_CLU044_(CLU044-1212B8-303M1A2)_1300.9lm@250mA_P=8.14849W_I=249.9mA

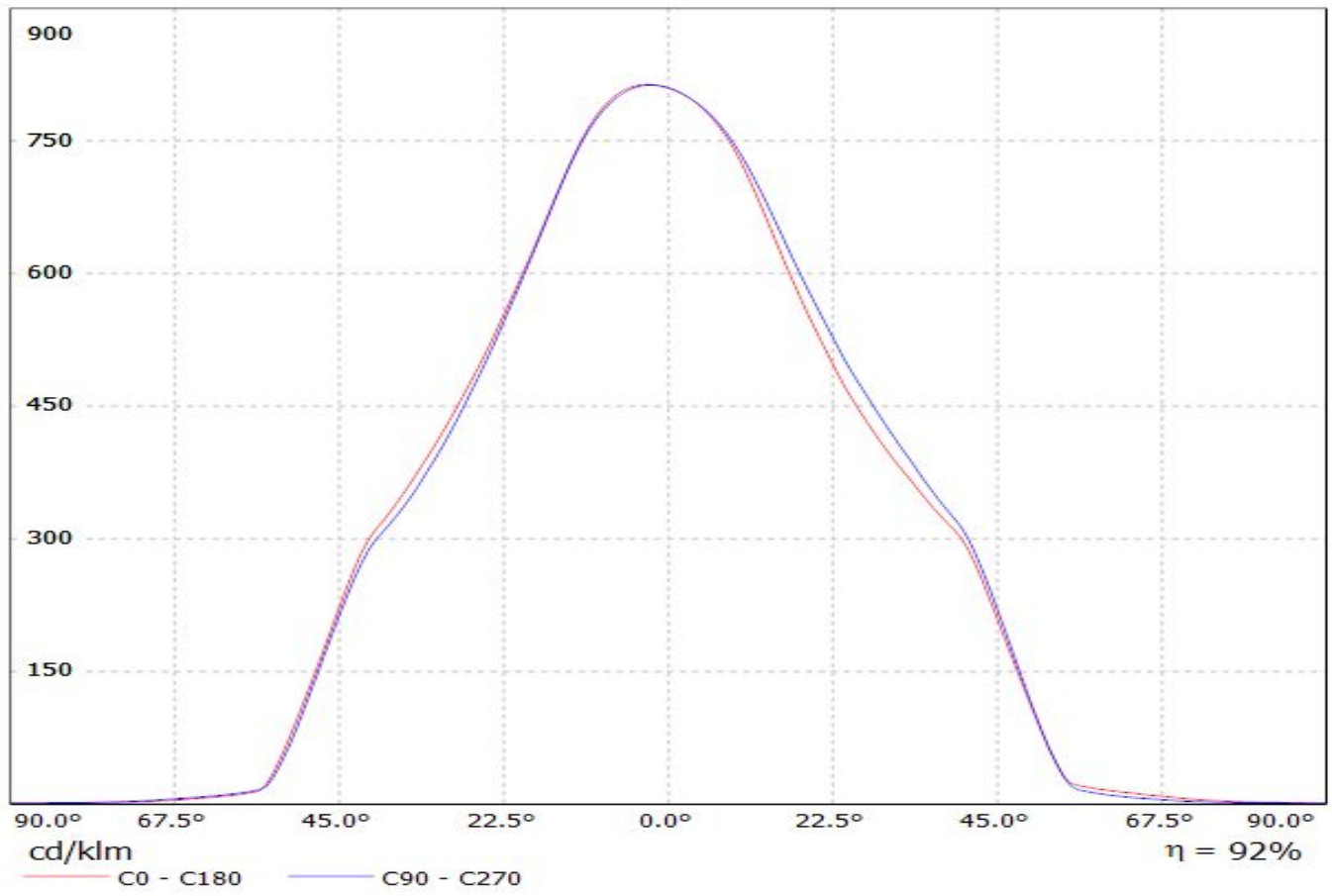

Luminaire: LEDiL Oy FC13979_ANGELINA-RZ-W-B_(CLU044)_+_ (Stucchi_8102-G2)

Lamps: 1 x Citizen_CLU044_(1212B8-303M1A2)_+_ (Stucchi_8102/G2)_1291.68lm@250mA_P=8.13748W_I=0.250A

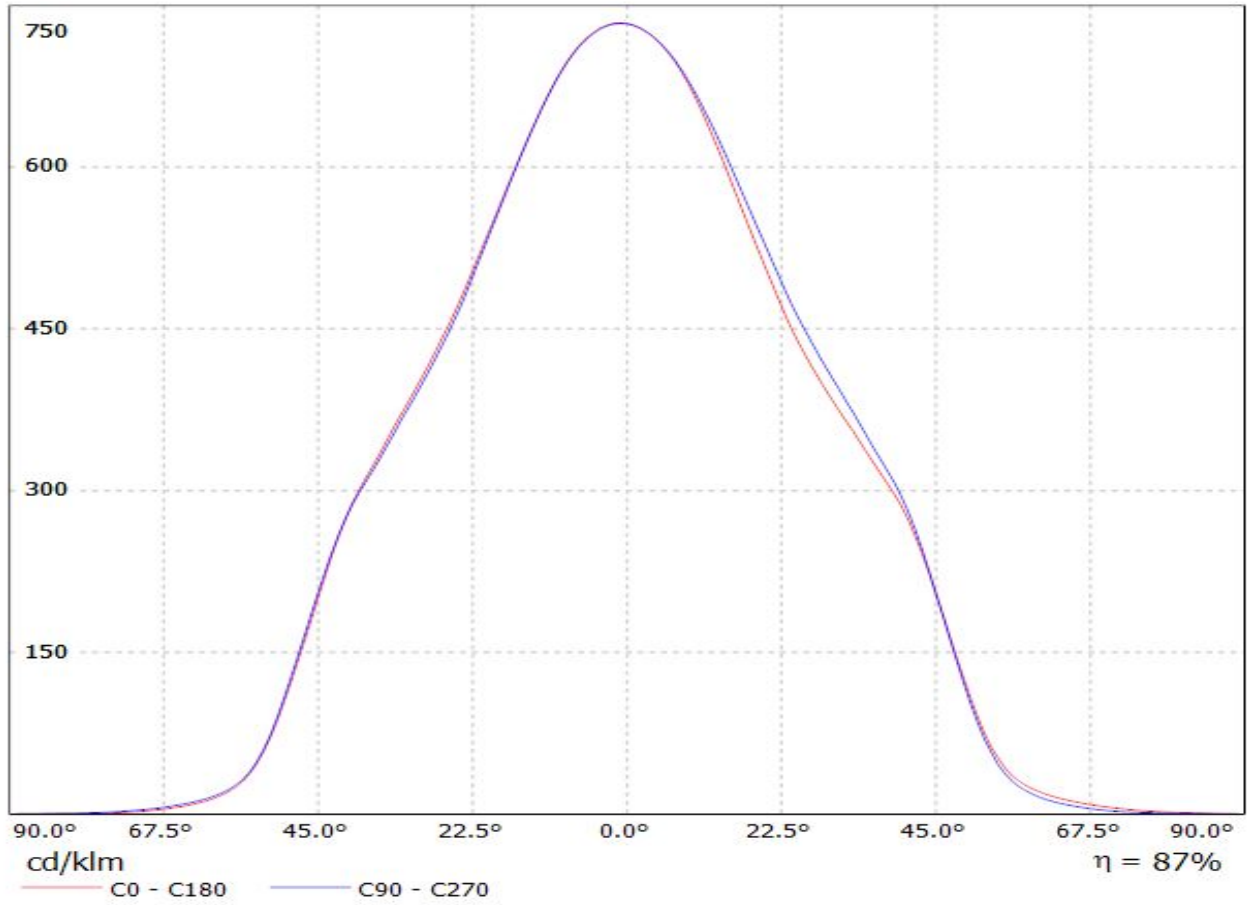

Luminaire: Ledil FCN13912_ANGELINA-XW (CLU044) (431_Typ_L3)
Lamps: 1 x Citizen_CLU044_(CLU044-1212B8-303M1A2)_1272.54lm@250mA_P=8.16W_I=0.25A

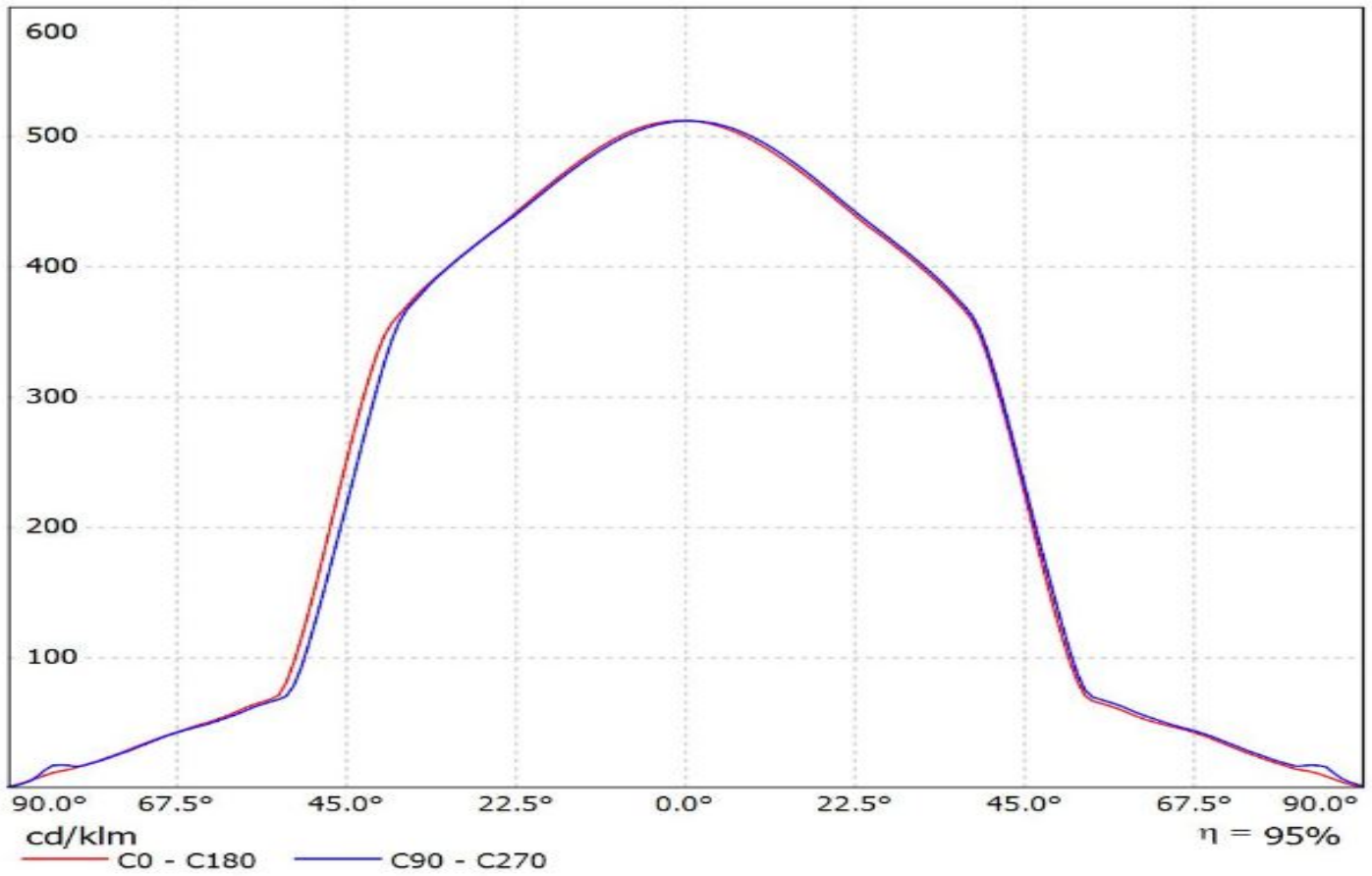

Luminaire: LEDiL Oy F13839_ANGELINA-XW-B_(CLL042) Eff: 94%
Lamps: 1 x Citizen_CLL042_(CLL042-1218A5-303H3-D2)_959.2lm@250mA_P=8.04978W_I=0.2499A

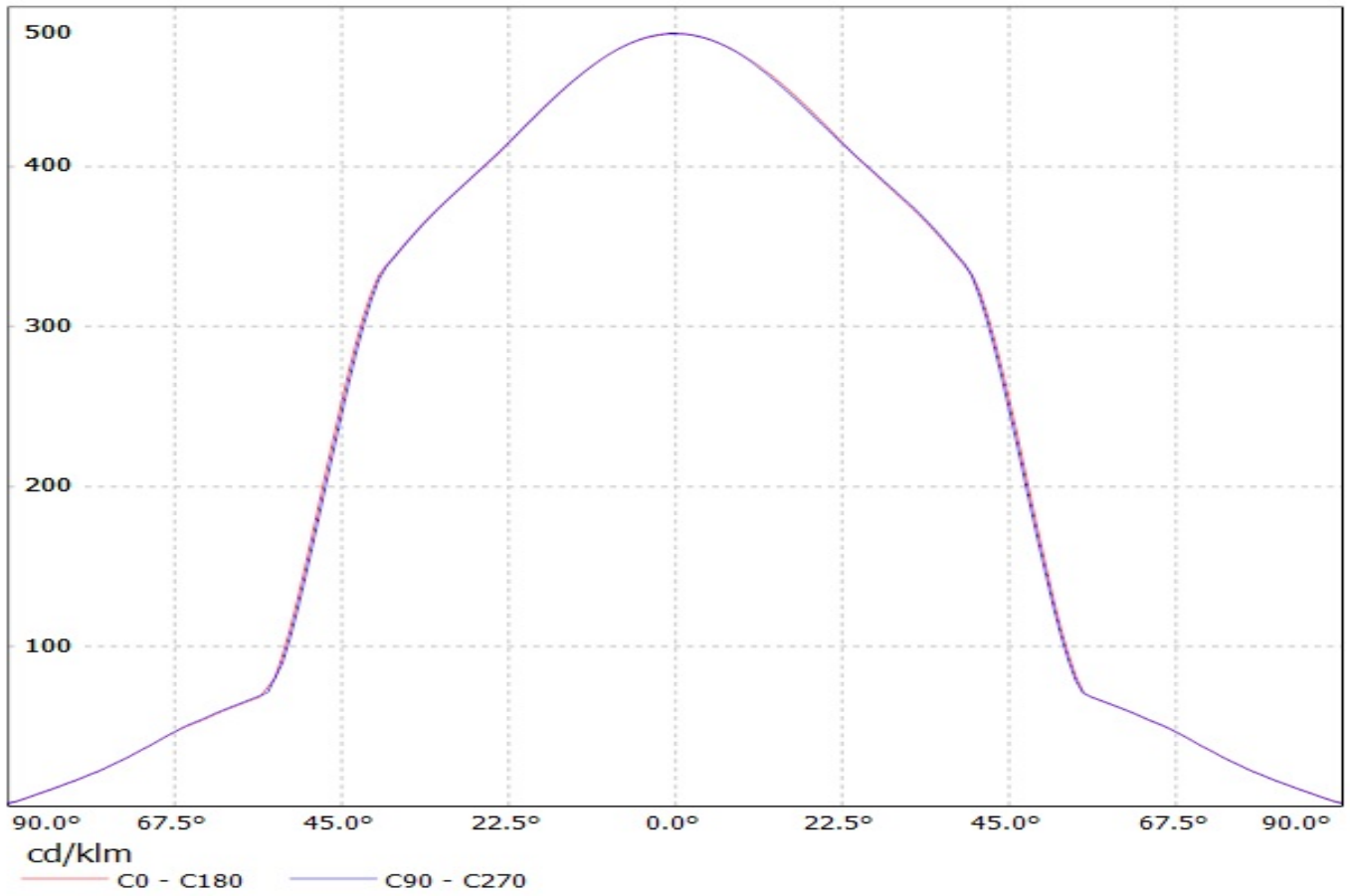

Luminaire: LEDiL Oy FC13982_ANGELINA-RZ-XW-B_(CLU044)_(Stucchi_8102-G2)
Lamps: 1 x Citizen_CLU044_(1212B8-303M1A2)_+_ (Stucchi_8102/G2)_1291.68lm@250mA_P=8.13748W_I=0.250A

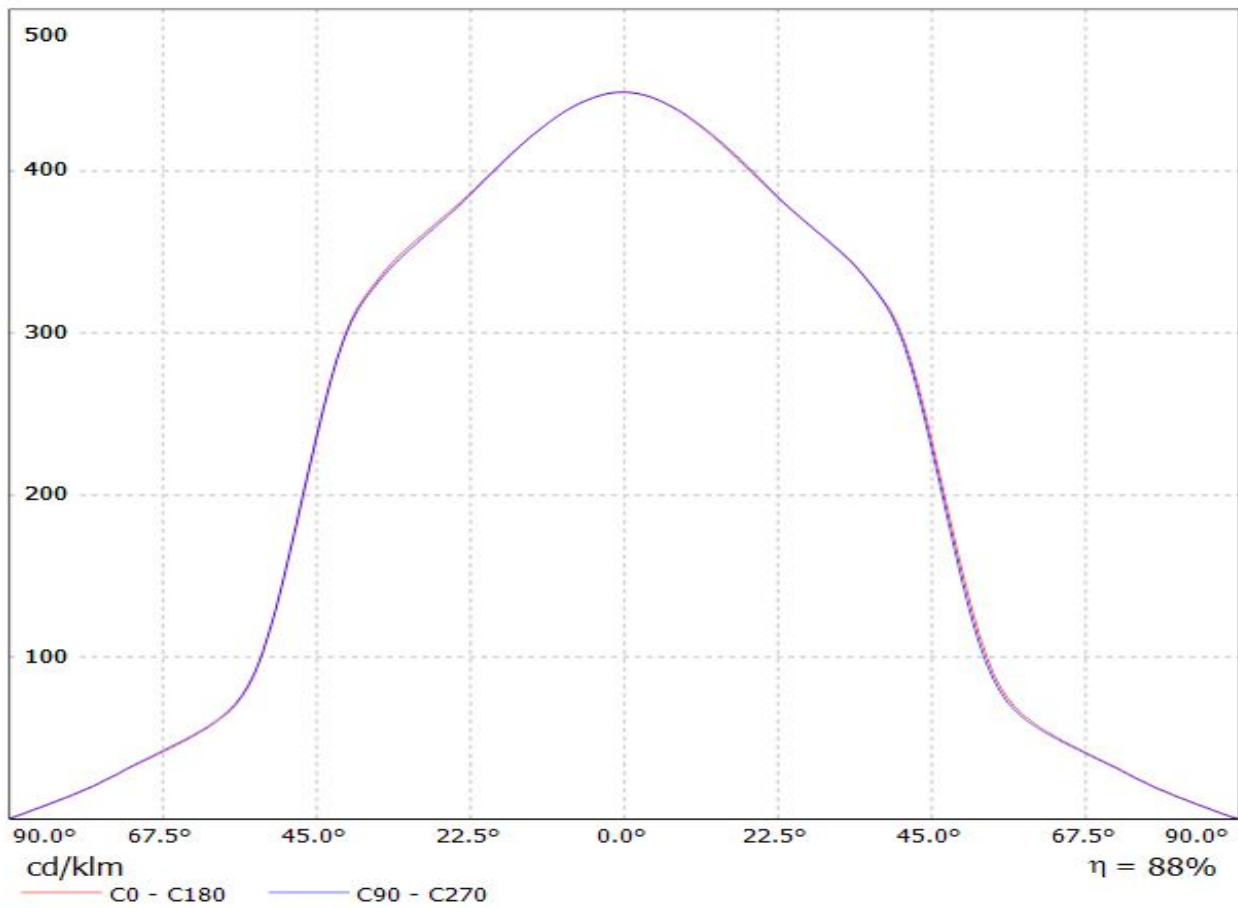

Luminaire: LEDiL Oy F13839_ANGELINA-XW-B_(CLU044)

Lamps: 1 x Citizen_CLU044_(CLU044-1212B8-303M1A2)_1300.9lm@250mA_P=8.14849W_I=249.9mA

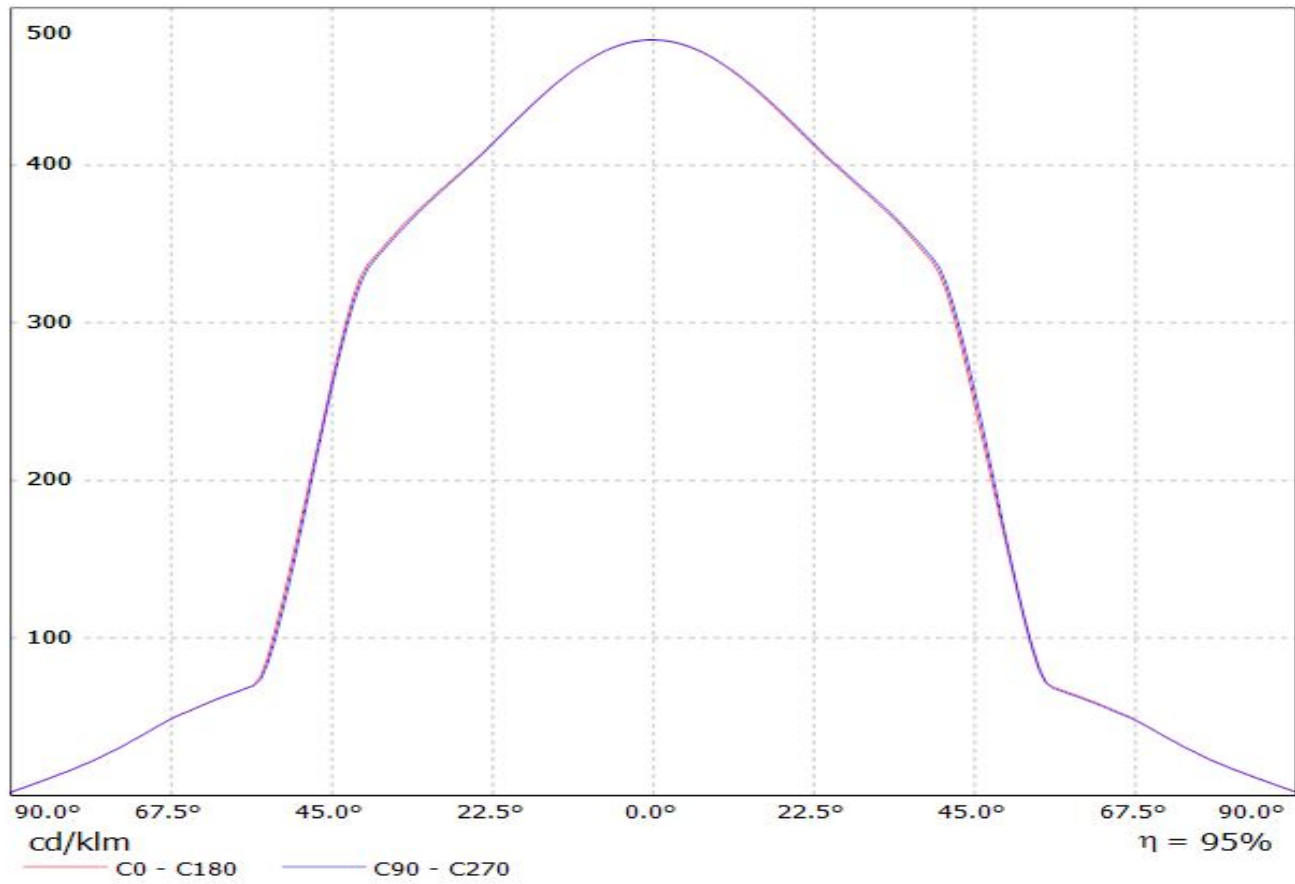

Luminaire: Ledil Oy F13661_ANGELINA-W-B_(CLU048)_(47_319_2030)_SIMULATED
Lamps: 1 x Citizen CLU048 (CLU048-1212C4-303M2K1) + BJB connector 47.319.2030

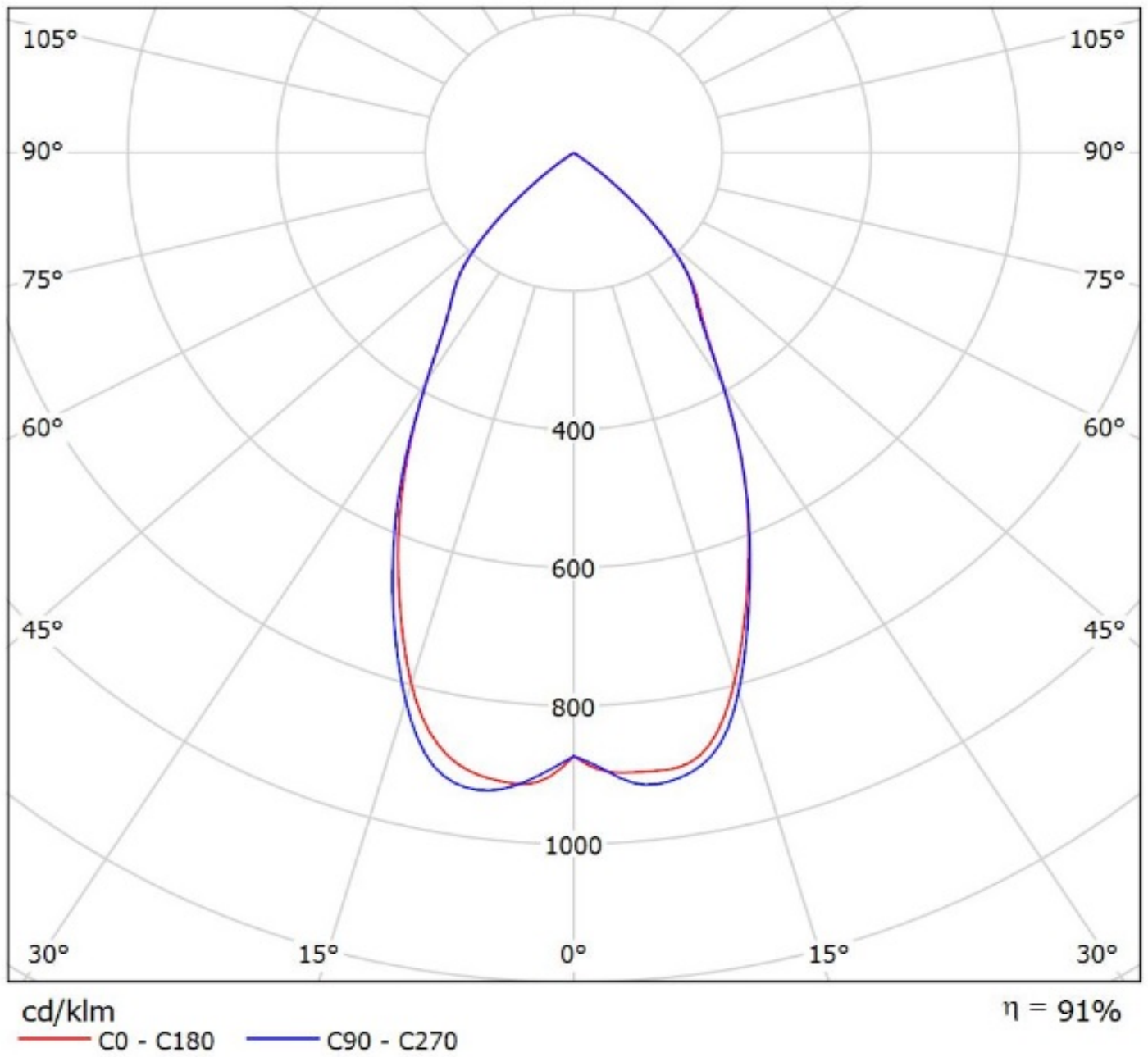

Luminaire: Ledil FCN13691_ANGELINA-S_(CLU044)_ (431_Typ_L3)

Lamps: 1 x Citizen_CLU044_(CLU044-1212B8-303M1A2)_ 1272.54lm@250mA_P=8.16W_I=0.25A

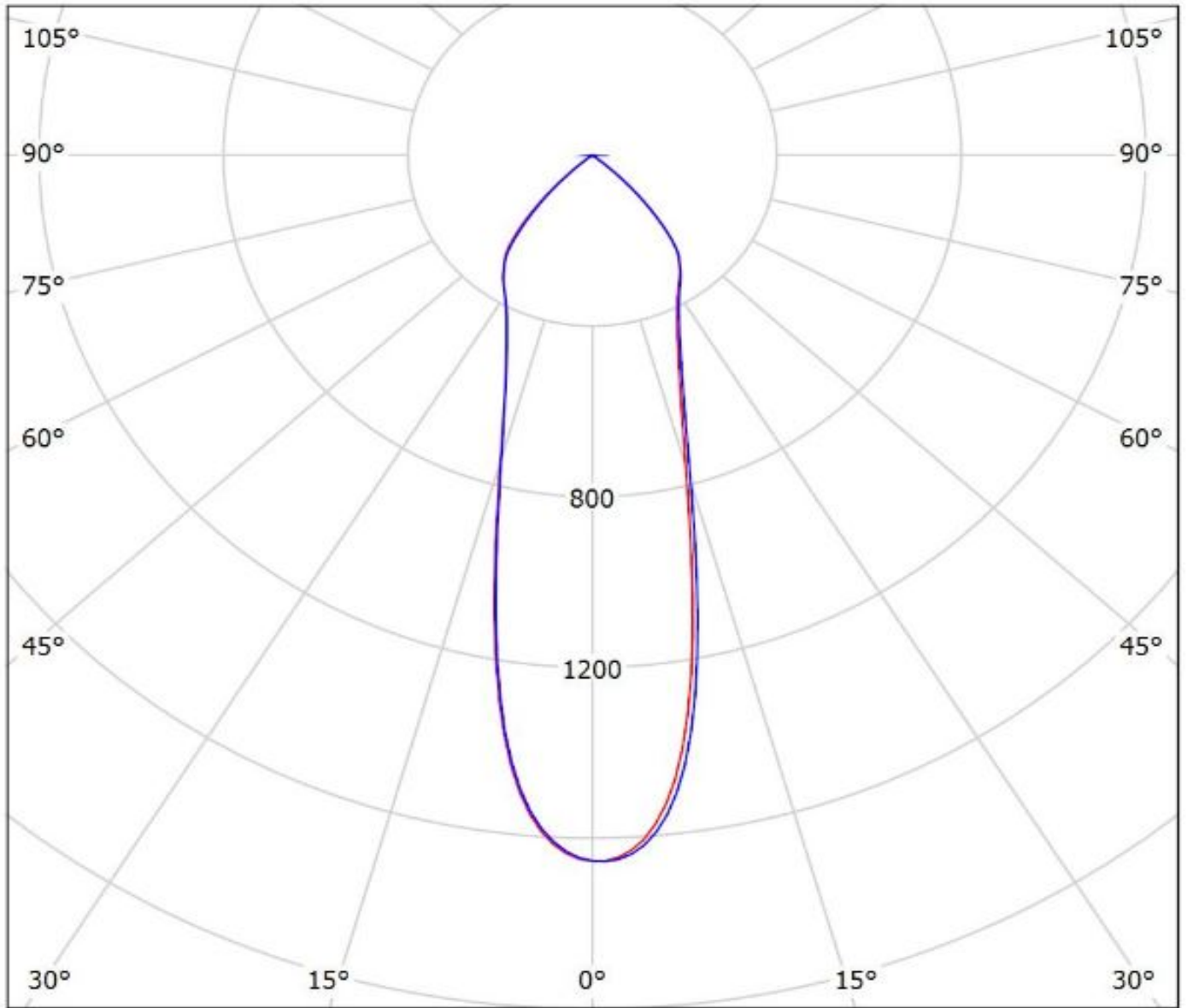

cd/klm

— C0 - C180 — C90 - C270

$\eta = 93\%$

Luminaire: Ledil F13325_ANGELINA-S_(CLU046+IDEAL)

Lamps: 1 x Citizen_CLU046_(-1212C1-303M2G2)_1383.92lm@250mA_CCT=3000K_P=8.122W_I=0.25A

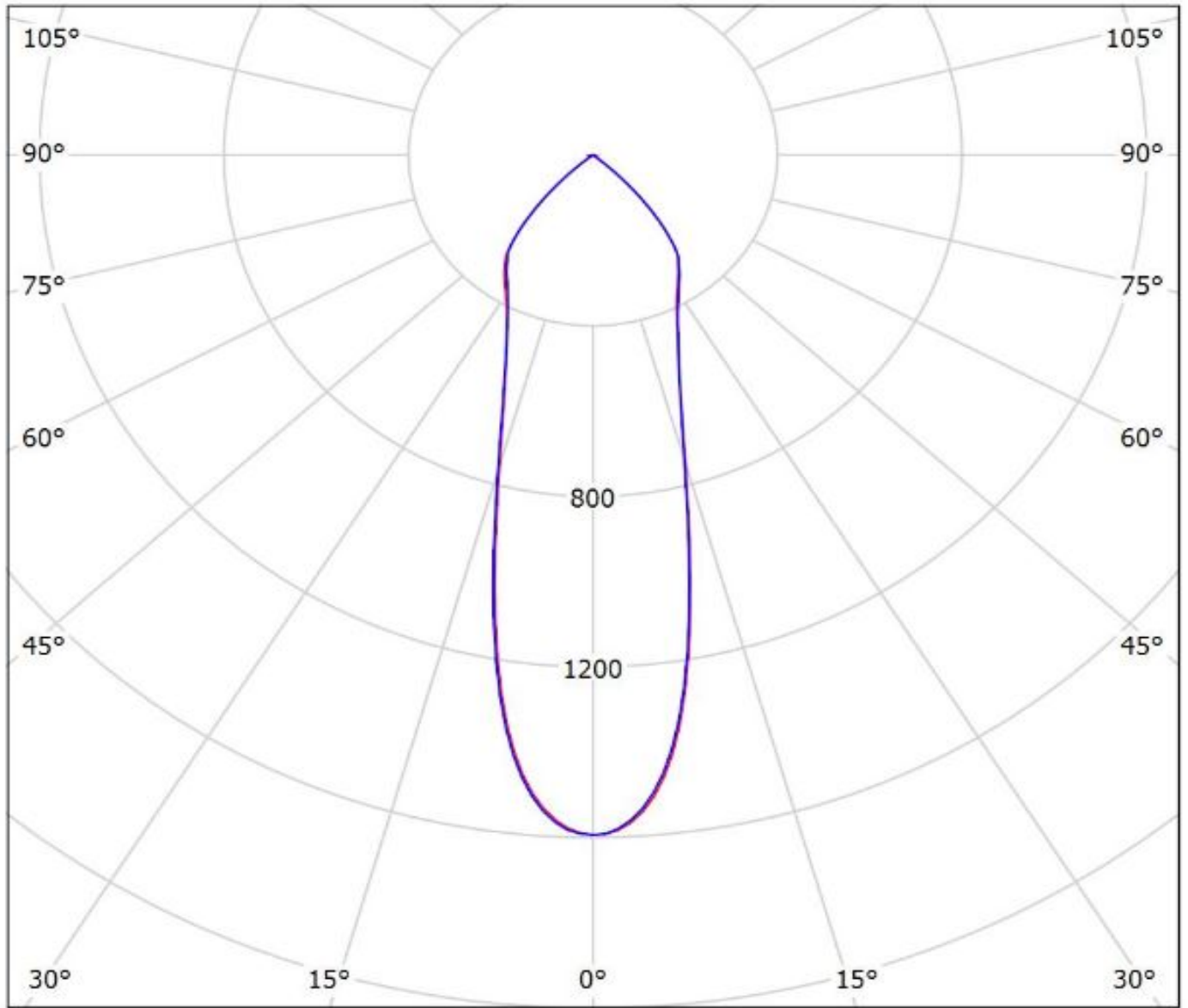

cd/klm

— C0 - C180 — C90 - C270

$\eta = 92\%$

Luminaire: LEDiL Oy F13659_ANGELINA-S-B_(CLU044)

Lamps: 1 x Citizen_CLU044_(CLU044-1212B8-303M1A2)_1300.9lm@250mA_P=8.14849W_I=249.9mA

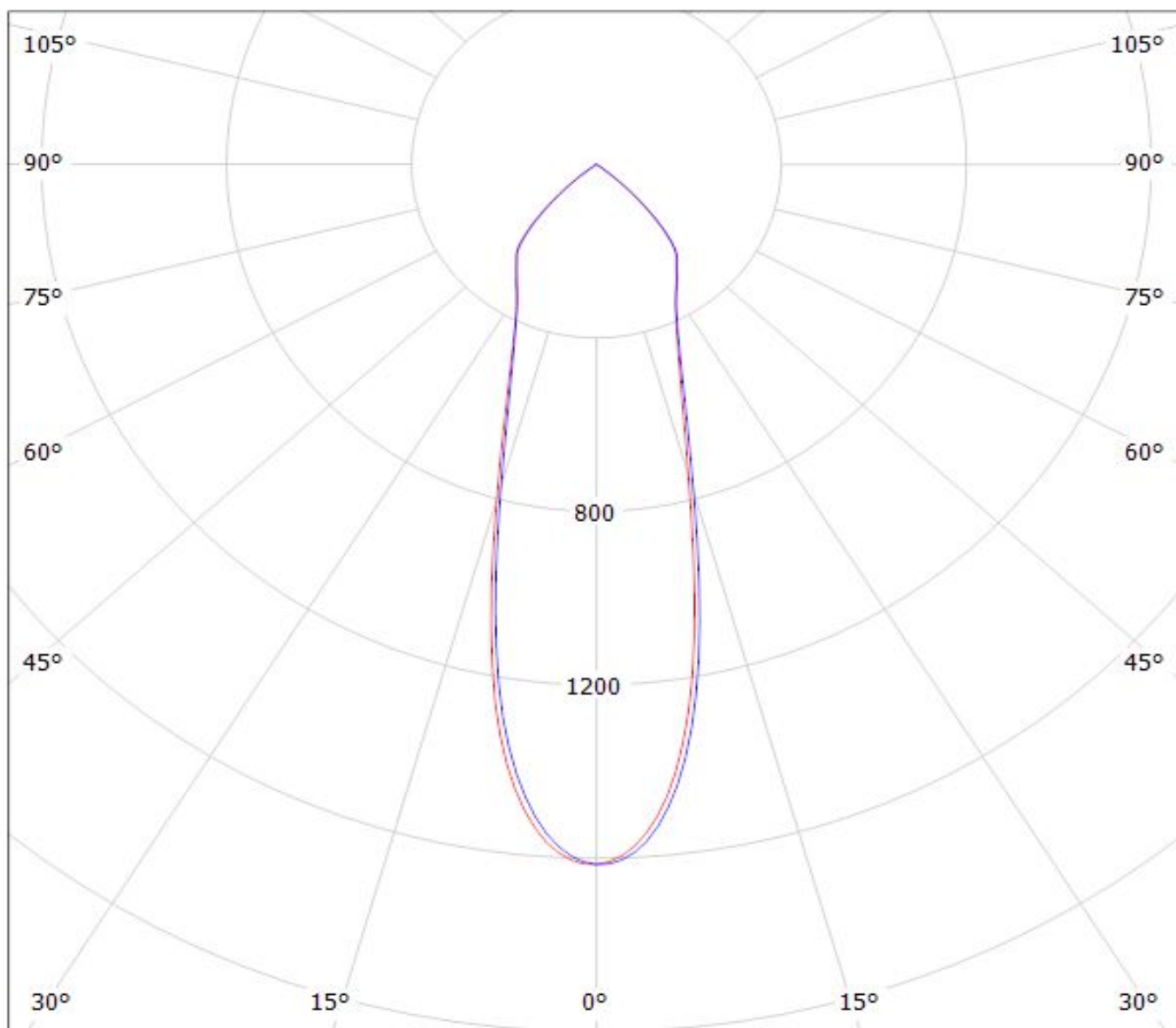

cd/klm

— C0 - C180

— C90 - C270

$\eta = 92\%$

Luminaire: LEDiL Oy FC13977_ANGELINA-RZ-S-B_(CLU044)_+_ (Stucchi_8102-G2)
Lamps: 1 x Citizen_CLU044_(1212B8-303M1A2)_+_ (Stucchi_8102/G2)_1291.68lm@250mA_P=8.13748W_I=0.250A

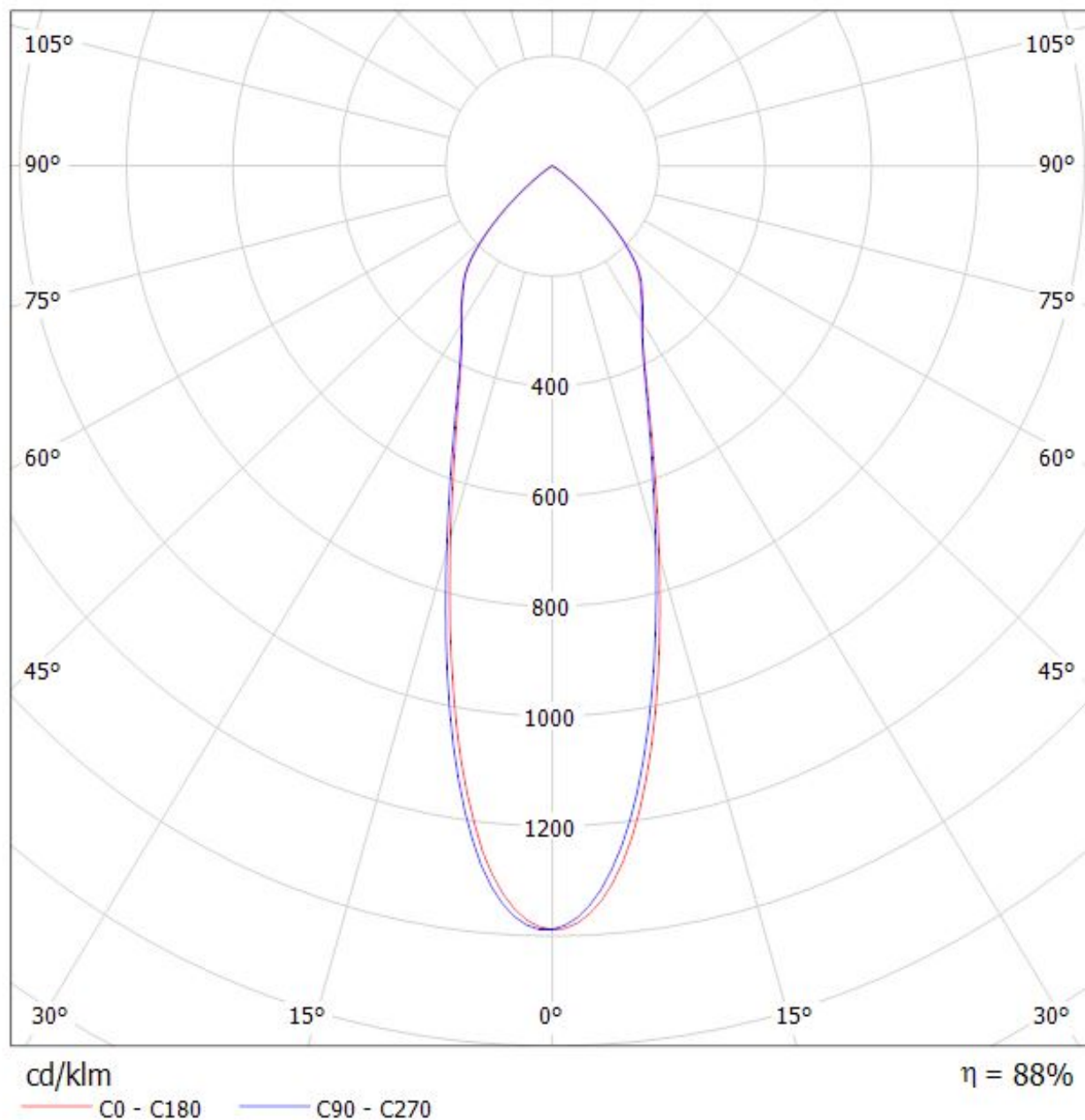

Luminaire: LEDiL Oy F13660_ANGELINA-M-B_(CLU044)

Lamps: 1 x Citizen_CLU044_(CLU044-1212B8-303M1A2)_1300.9lm@250mA_P=8.14849W_I=249.9mA

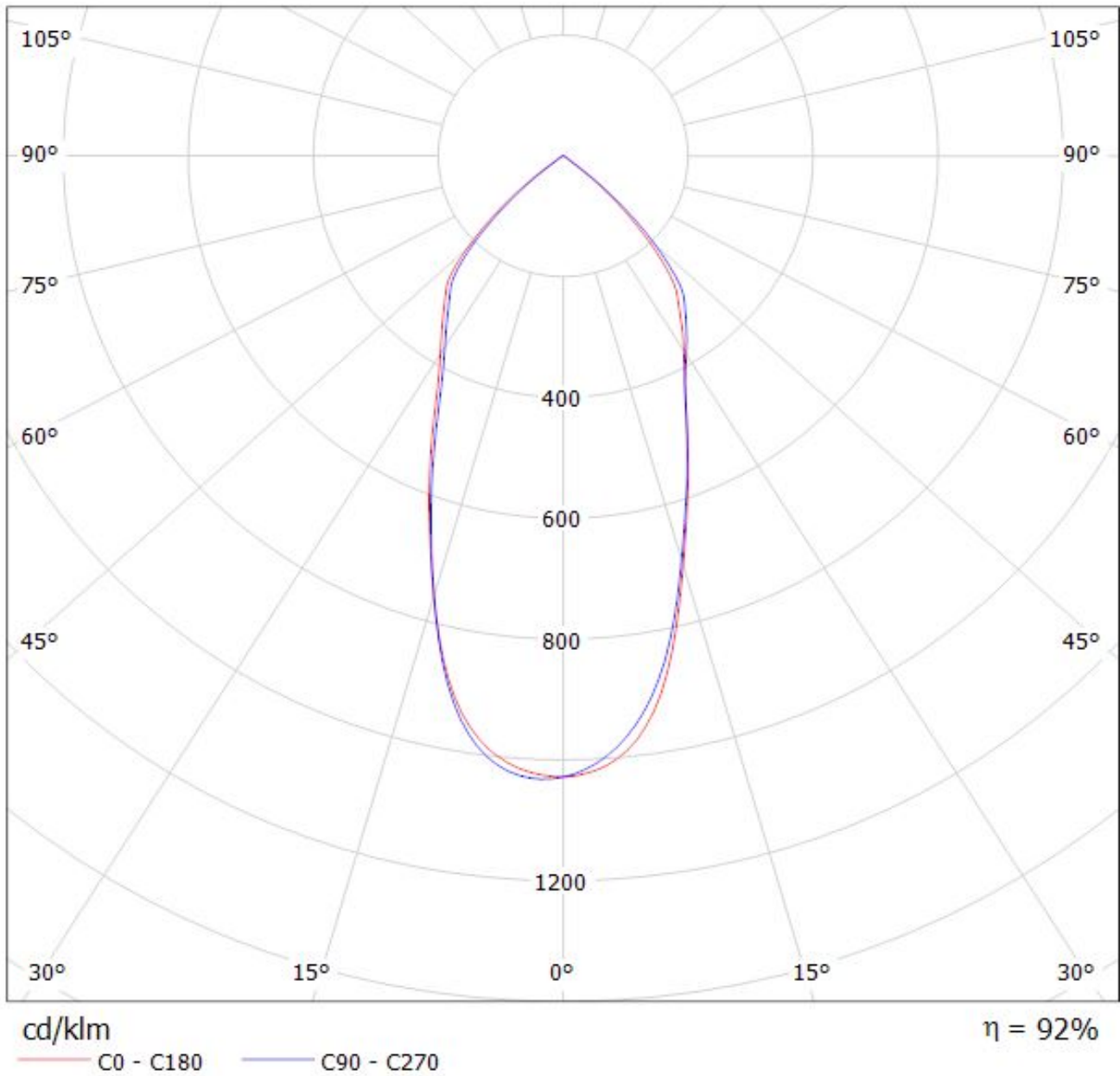

Luminaire: Ledil FCN13692_ANGELINA-M_(CLU044)_ (431_Typ_L3)

Lamps: 1 x Citizen_CLU044_(CLU044-1212B8-303M1A2)_1272.54lm@250mA_P=8.16W_I=0.25A

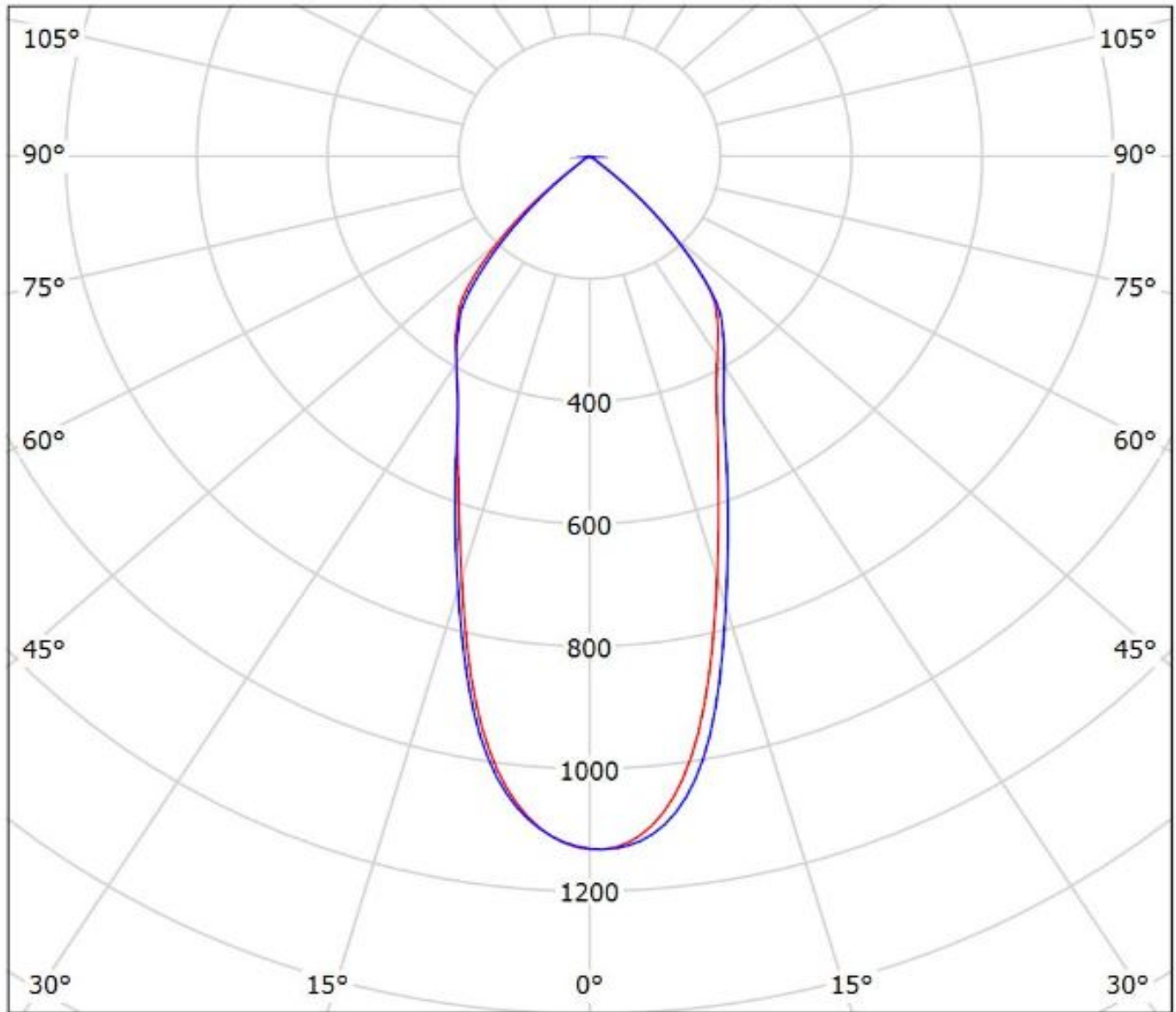

cd/klm

— C0 - C180 — C90 - C270

$\eta = 92\%$

Luminaire: Ledil F13401_ANGELINA-M (CLU046+IDEAL)

Lamps: 1 x Citizen_CLU046_(-1212C1-303M2G2)_1383.92lm@250mA_CCT=3000K_P=8.122W_I=0.25A

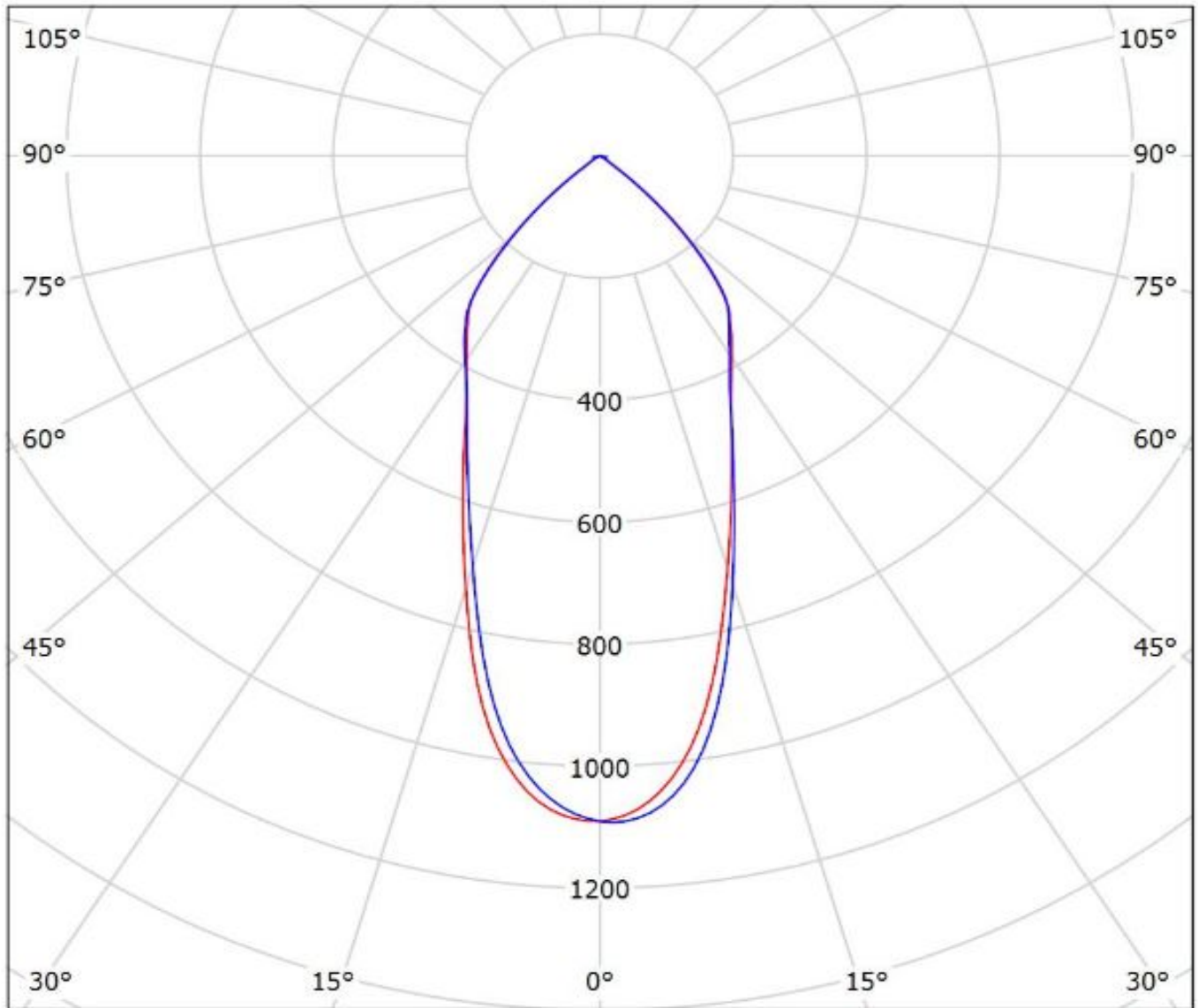

cd/klm

— C0 - C180 — C90 - C270

$\eta = 91\%$

Luminaire: Ledil F13402_ANGELINA-W_(CLU046+IDEAL)

Lamps: 1 x Citizen_CLU046_(-1212C1-303M2G2)_1383.92lm@250mA_CCT=3000K_P=8.122W_I=0.25A

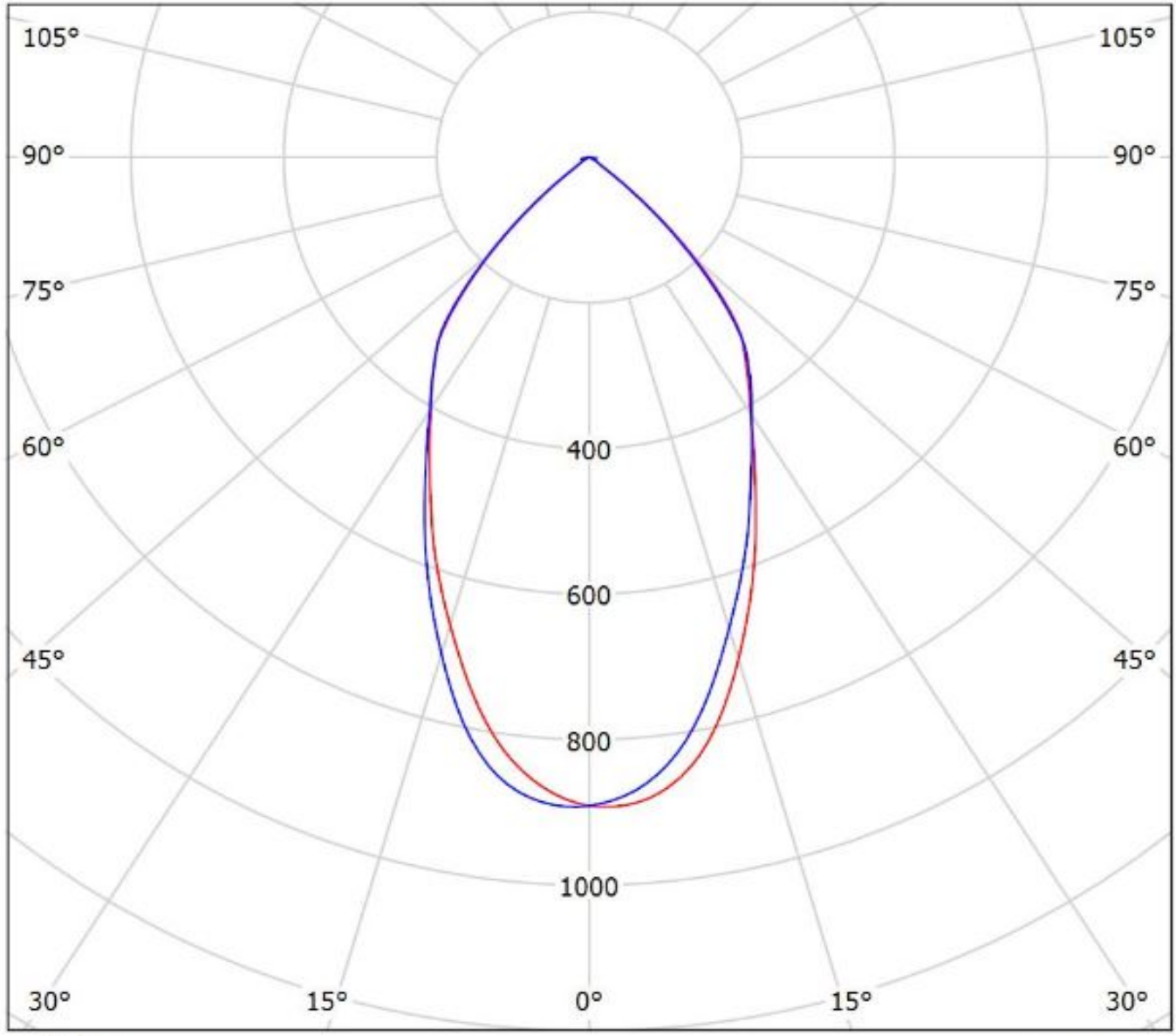

cd/klm

— C0 - C180 — C90 - C270

$\eta = 91\%$

Luminaire: LEDiL Oy FC13978_ANGELINA-RZ-M-B_(CLU044)_+_ (Stucchi_8102-G2)

Lamps: 1 x Citizen_CLU044_(1212B8-303M1A2)_+_ (Stucchi_8102/G2)_1291.68lm@250mA_P=8.13748W_I=0.250A

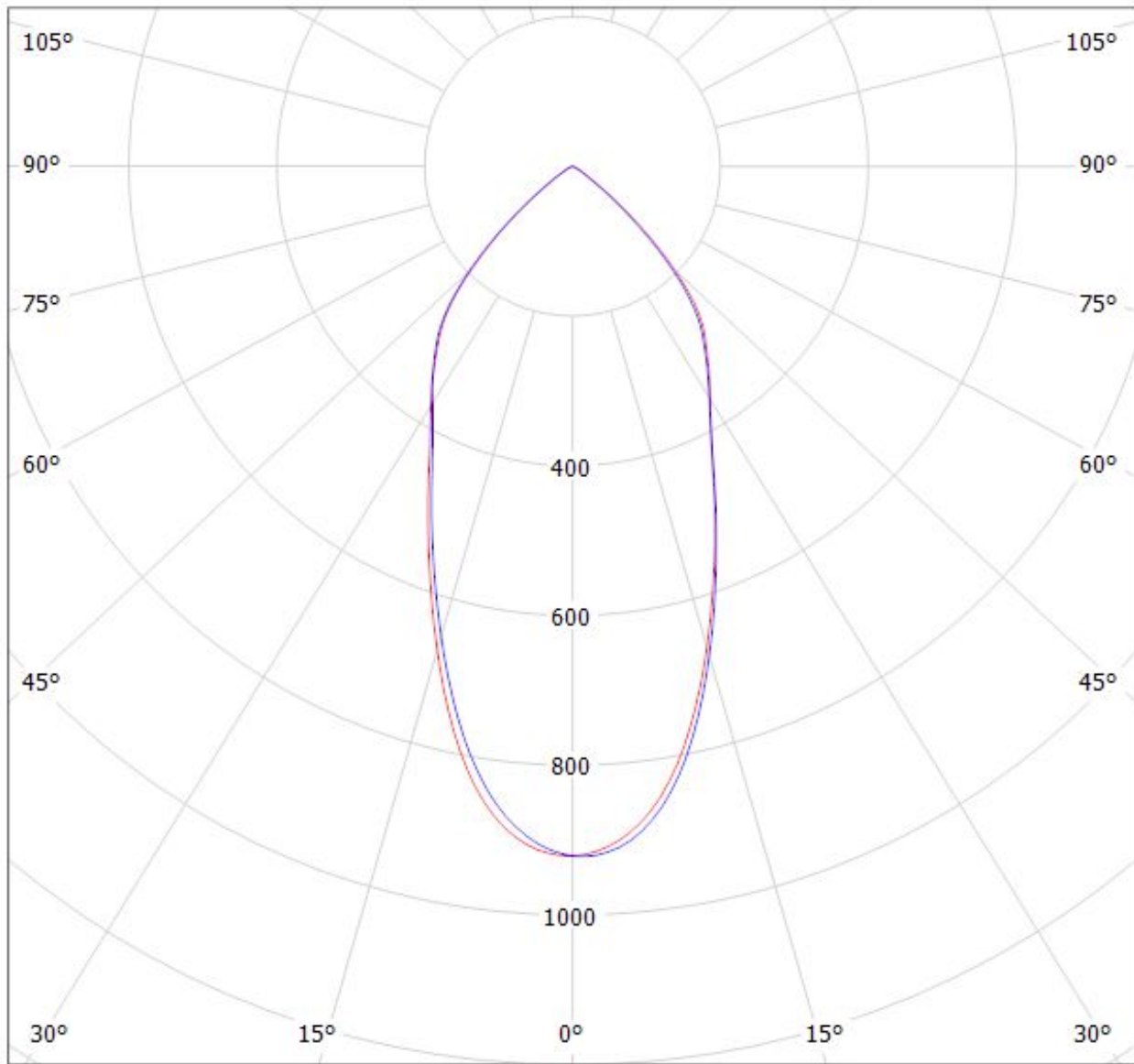

cd/klm

$\eta = 87\%$

— C0 - C180

— C90 - C270

Luminaire: Ledil FCN13693_ANGELINA-W_(CLU044)_ (431_Typ_L3)

Lamps: 1 x Citizen_CLU044_(CLU044-1212B8-303M1A2)_ 1272.54lm@250mA_P=8.16W_I=0.25A

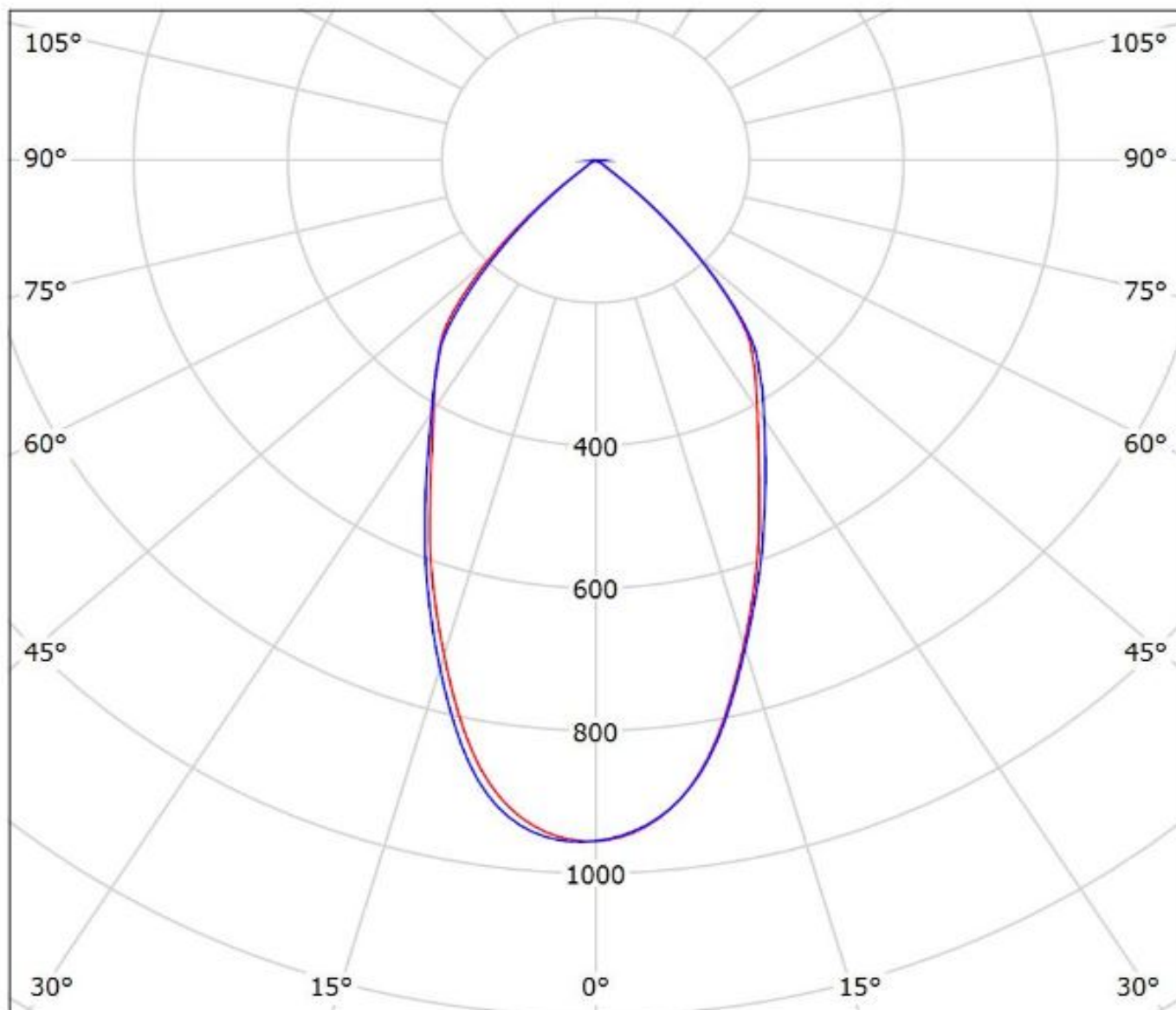

cd/klm

— C0 - C180 — C90 - C270

$\eta = 92\%$

Luminaire: LEDiL Oy F13661_ANGELINA-W-B_(CLU044)

Lamps: 1 x Citizen_CLU044_(CLU044-1212B8-303M1A2)_1300.9lm@250mA_P=8.14849W_I=249.9mA

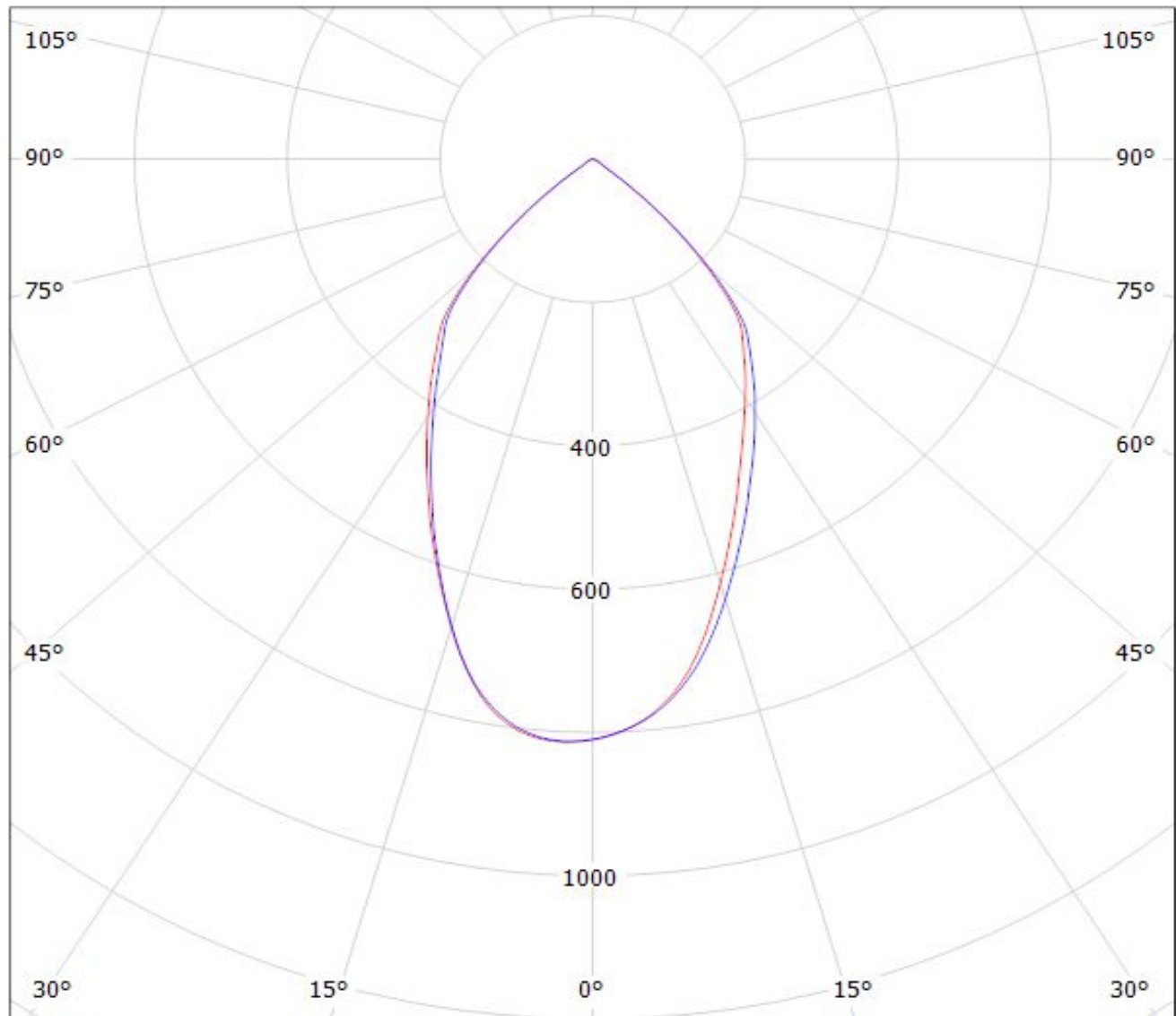

cd/klm

— C0 - C180

— C90 - C270

$\eta = 92\%$

Luminaire: LEDiL Oy FC13979_ANGELINA-RZ-W-B_(CLU044)_+(Stucchi_8102-G2)
Lamps: 1 x Citizen_CLU044_(1212B8-303M1A2)_+(Stucchi_8102/G2)_1291.68lm@250mA_P=8.13748W_I=0.250A

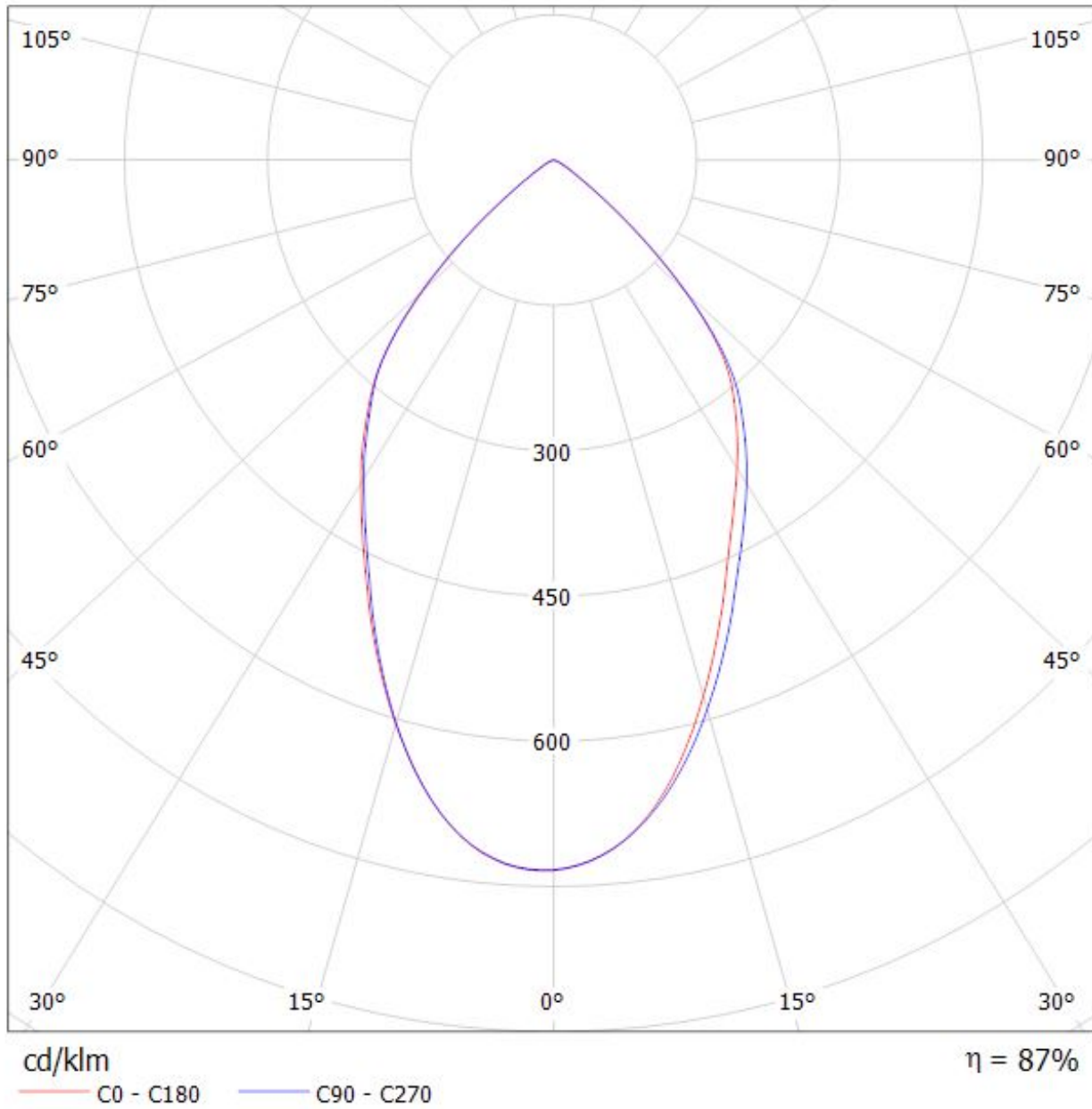

Luminaire: Ledil FCN13912_ANGELINA-XW_(CLU044)_ (431_Typ_L3)

Lamps: 1 x Citizen_CLU044_(CLU044-1212B8-303M1A2)_ 1272.54lm@250mA_P=8.16W_I=0.25A

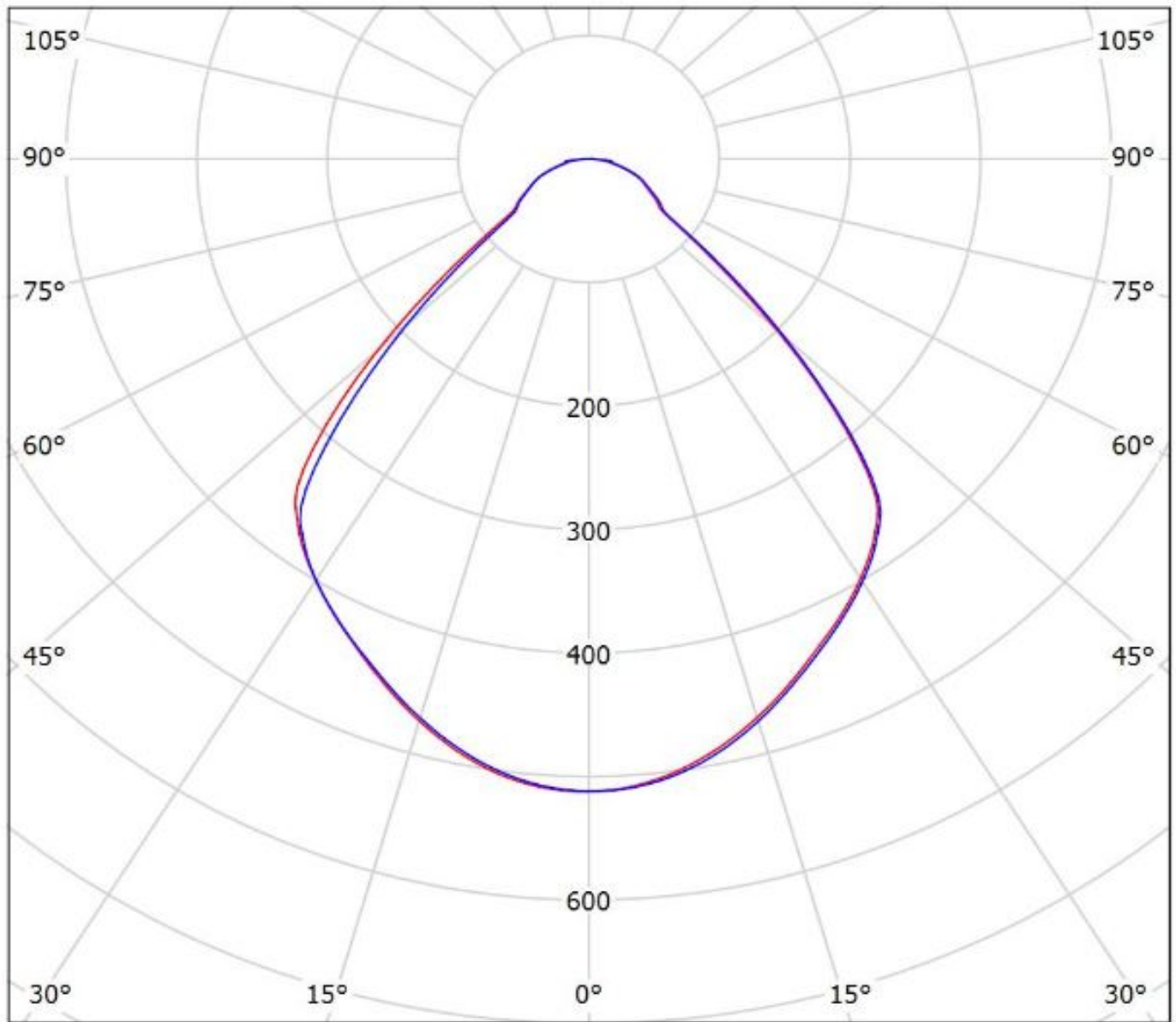

cd/klm

— C0 - C180 — C90 - C270

$\eta = 95\%$

Luminaire: LEDiL Oy F13839_ANGELINA-XW-B_(CLL042) Eff: 94%

Lamps: 1 x Citizen_CLL042_(CLL042-1218A5-303H3-D2)_959.2lm@250mA_P=8.04978W_I=0.2499A

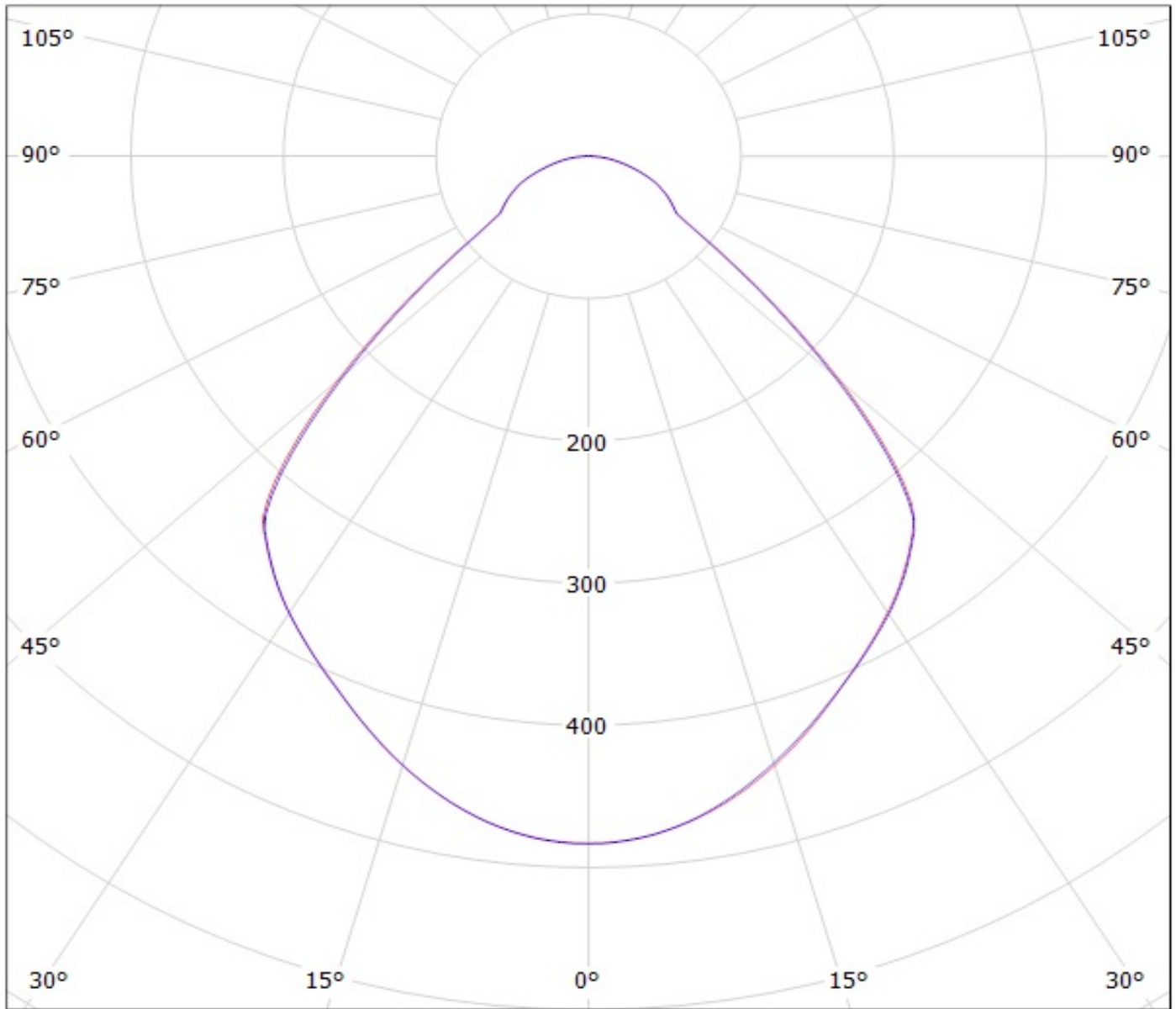

cd/klm

— C0 - C180

— C90 - C270

Luminaire: LEDiL Oy FC13982_ANGELINA-RZ-XW-B_(CLU044)_(Stucchi_8102-G2)

Lamps: 1 x Citizen_CLU044_(1212B8-303M1A2)_+(Stucchi_8102/G2)_1291.68lm@250mA_P=8.13748W_I=0.250A

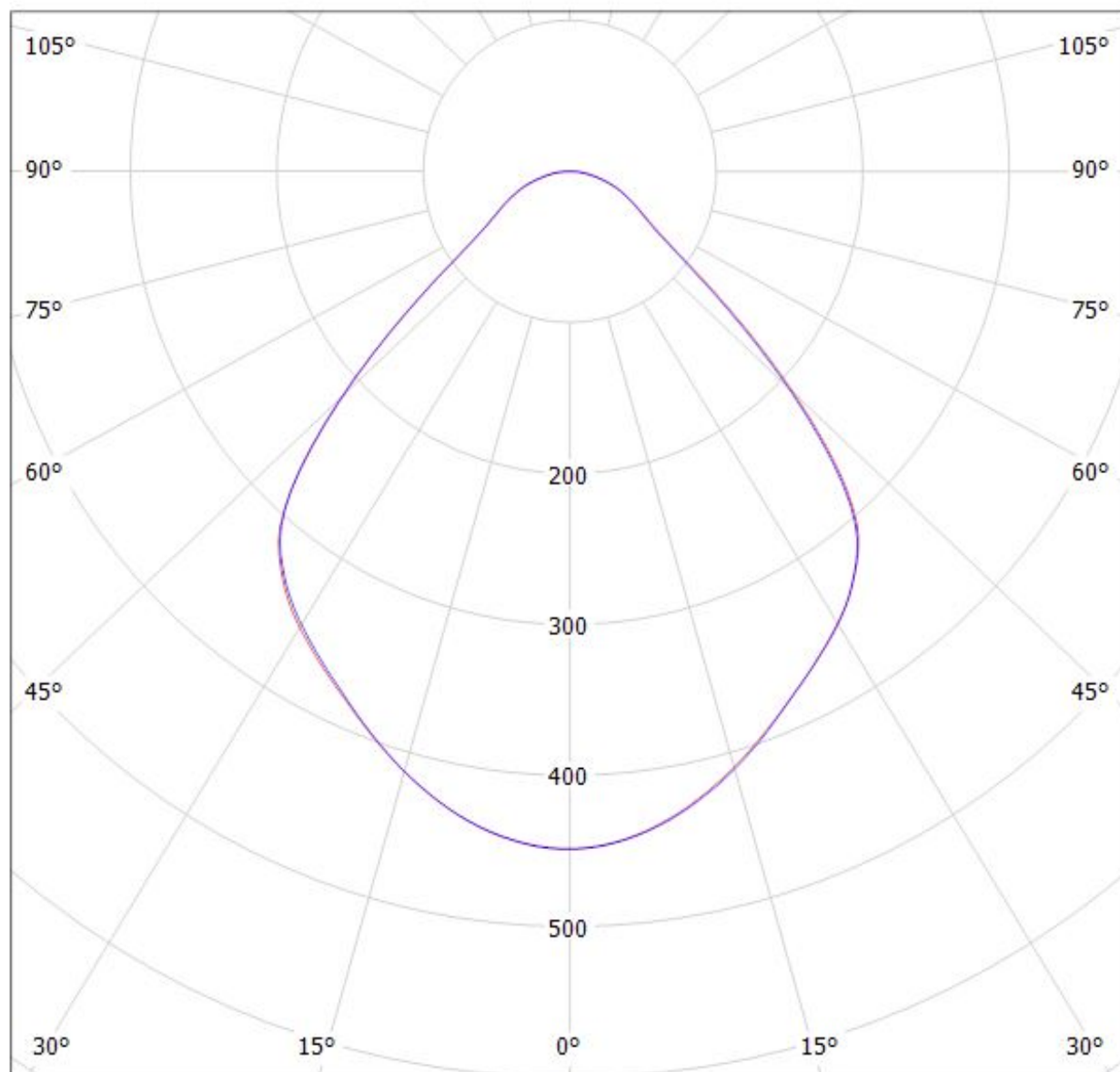

cd/klm

— C0 - C180

— C90 - C270

$\eta = 88\%$

Luminaire: LEDiL Oy F13839_ANGELINA-XW-B_(CLU044)

Lamps: 1 x Citizen_CLU044_(CLU044-1212B8-303M1A2)_1300.9lm@250mA_P=8.14849W_I=249.9mA

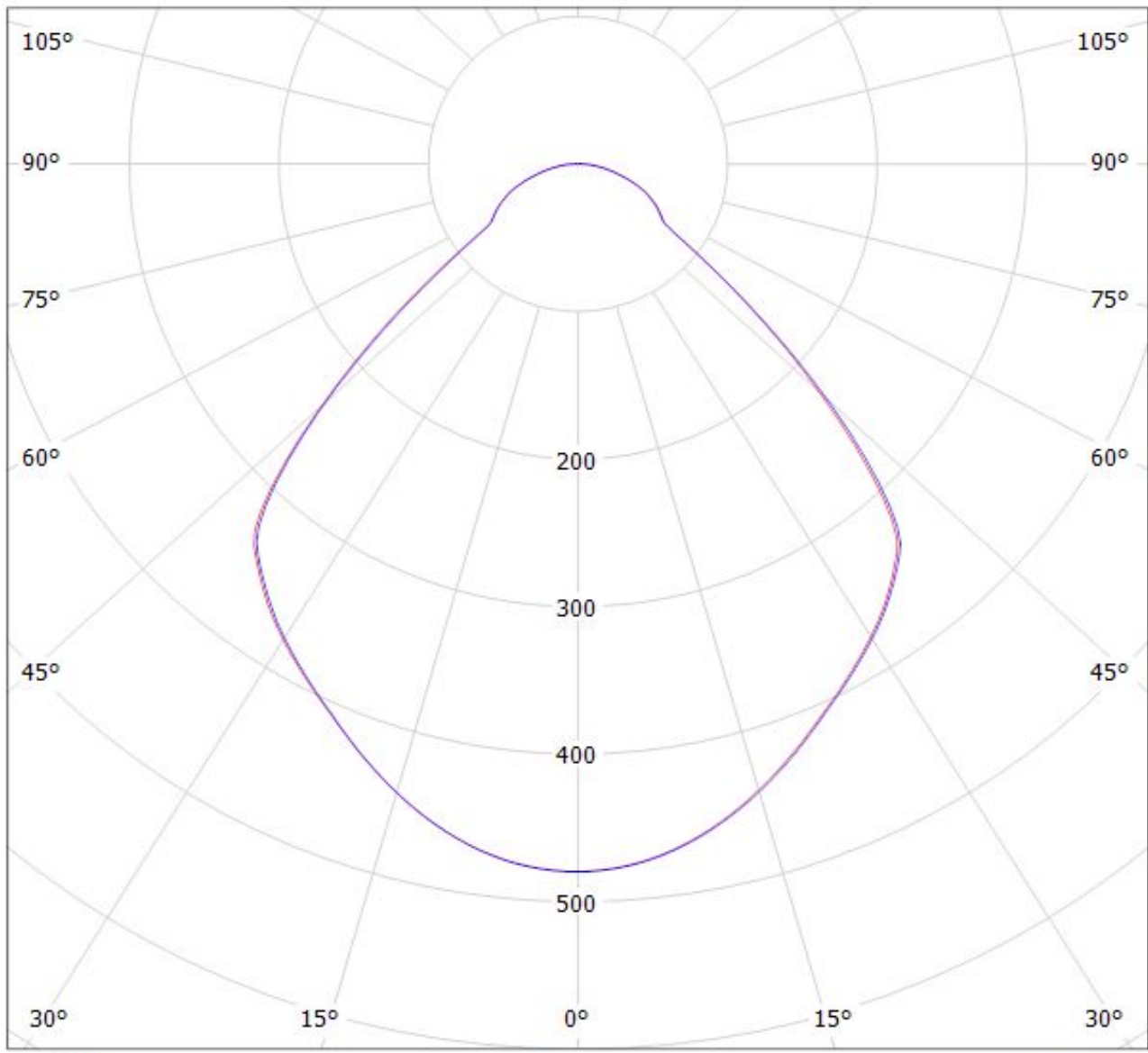

cd/klm

— C0 - C180

— C90 - C270

$\eta = 95\%$