

# FMC 1,5/ 5-ST-3,5 - Printed-circuit board connector



1952296

<https://www.phoenixcontact.com/us/products/1952296>

Please be informed that the data shown in this PDF document is generated from our online catalog. Please find the complete data in the user documentation. Our general terms of use for downloads are valid.

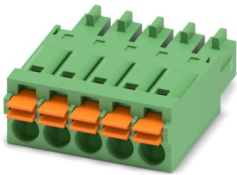

PCB connector, nominal cross section: 1.5 mm<sup>2</sup>, color: green, nominal current: 8 A, rated voltage (III/2): 160 V, contact surface: Tin, contact connection type: Socket, number of potentials: 5, number of rows: 1, number of positions: 5, number of connections: 5, product range: FMC 1,5/..-ST, pitch: 3.5 mm, connection method: Push-in spring connection, conductor/PCB connection direction: 0 °, plug-in system: COMBICON MC 1,5, locking: without, mounting: without, type of packaging: packed in cardboard

## Your advantages

- Time saving push-in connection, tools not required
- Defined contact force ensures that contact remains stable over the long term
- Intuitive operation due to color-coded actuating push button
- Operation and conductor connection from one direction enable integration into front of device

## Commercial data

Item number	1952296
Packing unit	250 pc
Minimum order quantity	250 pc
Sales key	AA02
Product key	AABFAA
Catalog page	Page 200 (C-1-2013)
GTIN	4017918942885
Weight per piece (including packing)	2.9 g
Weight per piece (excluding packing)	2.72 g
Customs tariff number	85366990
Country of origin	DE

# FMC 1,5/ 5-ST-3,5 - Printed-circuit board connector



1952296

<https://www.phoenixcontact.com/us/products/1952296>

## Technical data

### Product properties

Type	Standard
Product line	COMBICON Connectors S
Product type	PCB connector
Product family	FMC 1,5/..-ST
Number of positions	5
Pitch	3.5 mm
Number of connections	5
Number of rows	1
Mounting flange	without
Number of potentials	5

### Electrical properties

Nominal current $I_N$	8 A
Nominal voltage $U_N$	160 V
Degree of pollution	3
Contact resistance	1.5 m $\Omega$
Rated voltage (III/3)	160 V
Rated surge voltage (III/3)	2.5 kV
Rated voltage (III/2)	160 V
Rated surge voltage (III/2)	2.5 kV
Rated voltage (II/2)	320 V
Rated surge voltage (II/2)	2.5 kV

### Connection data

#### Connection technology

Type	Standard
Connector system	COMBICON MC 1,5
Nominal cross section	1.5 mm <sup>2</sup>
Contact connection type	Socket

#### Interlock

Locking type	without
Mounting flange	without

#### Conductor connection

Connection method	Push-in spring connection
Conductor/PCB connection direction	0 °
Conductor cross section rigid	0.2 mm <sup>2</sup> ... 1.5 mm <sup>2</sup>
Conductor cross section flexible	0.2 mm <sup>2</sup> ... 1.5 mm <sup>2</sup>
Conductor cross section AWG	24 ... 16
Conductor cross section flexible, with ferrule without plastic	0.25 mm <sup>2</sup> ... 1.5 mm <sup>2</sup>

# FMC 1,5/ 5-ST-3,5 - Printed-circuit board connector



1952296

<https://www.phoenixcontact.com/us/products/1952296>

sleeve	
Conductor cross section, flexible, with ferrule, with plastic sleeve	0.14 mm <sup>2</sup> ... 0.75 mm <sup>2</sup>
Cylindrical gauge a x b / diameter	2.4 mm x 1.5 mm / 1.6 mm
Stripping length	10 mm

## Specifications for ferrules without insulating collar

recommended crimping tool	1212034 CRIMPFOX 6
ferrules without insulating collar, according to DIN 46228-1	Cross section: 0.25 mm <sup>2</sup> ; Length: 7 mm
	Cross section: 0.34 mm <sup>2</sup> ; Length: 7 mm
	Cross section: 0.5 mm <sup>2</sup> ; Length: 8 mm ... 10 mm
	Cross section: 0.75 mm <sup>2</sup> ; Length: 8 mm ... 10 mm
	Cross section: 1 mm <sup>2</sup> ; Length: 8 mm ... 10 mm
	Cross section: 1.5 mm <sup>2</sup> ; Length: 10 mm

## Specifications for ferrules with insulating collar

recommended crimping tool	1212034 CRIMPFOX 6
ferrules with insulating collar, according to DIN 46228-4	Cross section: 0.14 mm <sup>2</sup> ; Length: 8 mm
	Cross section: 0.25 mm <sup>2</sup> ; Length: 8 mm ... 10 mm
	Cross section: 0.34 mm <sup>2</sup> ; Length: 8 mm ... 10 mm
	Cross section: 0.5 mm <sup>2</sup> ; Length: 8 mm ... 10 mm
	Cross section: 0.75 mm <sup>2</sup> ; Length: 10 mm

## Material specifications

### Material data - contact

Note	WEEE/RoHS-compliant, free of whiskers according to IEC 60068-2-82/JEDEC JESD 201
Contact material	Cu alloy
Surface characteristics	hot-dip tin-plated
Metal surface terminal point (top layer)	Tin (4 - 8 µm Sn)
Metal surface contact area (top layer)	Tin (4 - 8 µm Sn)

### Material data - housing

Color (Housing)	green (6021)
Insulating material	PA
Insulating material group	I
CTI according to IEC 60112	600
Flammability rating according to UL 94	V0
Glow wire flammability index GWFI according to EN 60695-2-12	850
Glow wire ignition temperature GWIT according to EN 60695-2-13	775
Temperature for the ball pressure test according to EN 60695-10-2	125 °C

### Material data – actuating element

Color (Actuating element)	orange (2003)
Insulating material	PBT

# FMC 1,5/ 5-ST-3,5 - Printed-circuit board connector



1952296

<https://www.phoenixcontact.com/us/products/1952296>

Insulating material group	IIIa
CTI according to IEC 60112	275
Flammability rating according to UL 94	V0

## Dimensions

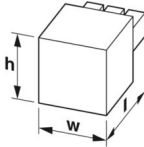
Dimensional drawing	
Pitch	3.5 mm
Width [w]	18.25 mm
Height [h]	7.75 mm
Length [l]	21.9 mm

## Mechanical tests

### Conductor connection

Specification	IEC 60999-1:1999-11
Result	Test passed

### Test for conductor damage and slackening

Specification	IEC 60999-1:1999-11
Result	Test passed

### Repeated connection and disconnection

Specification	IEC 60999-1:1999-11
Result	Test passed

### Pull-out test

Specification	IEC 60999-1:1999-11
Conductor cross section/conductor type/tractive force setpoint/actual value	0.2 mm <sup>2</sup> / solid / > 10 N
	0.2 mm <sup>2</sup> / flexible / > 10 N
	1.5 mm <sup>2</sup> / solid / > 40 N
	1.5 mm <sup>2</sup> / flexible / > 40 N

### Insertion and withdrawal forces

Result	Test passed
No. of cycles	25
Insertion strength per pos. approx.	8 N
Withdraw strength per pos. approx.	6 N

### Resistance of inscriptions

Specification	IEC 60068-2-70:1995-12
Result	Test passed

### Polarization and coding

# FMC 1,5/ 5-ST-3,5 - Printed-circuit board connector



1952296

<https://www.phoenixcontact.com/us/products/1952296>

Specification	IEC 60512-13-5:2006-02
Result	Test passed

## Visual inspection

Specification	IEC 60512-1-1:2002-02
Result	Test passed

## Dimension check

Specification	IEC 60512-1-2:2002-02
Result	Test passed

## Environmental and real-life conditions

### Vibration test

Specification	IEC 60068-2-6:2007-12
Frequency	10 - 150 - 10 Hz
Sweep speed	1 octave/min
Amplitude	0.35 mm (10 Hz ... 60.1 Hz)
Sweep speed	5g (60.1 Hz ... 150 Hz)
Test duration per axis	2.5 h

### Durability test

Specification	IEC 60512-9-1:2010-03
Impulse withstand voltage at sea level	2.95 kV
Contact resistance R <sub>1</sub>	1.5 mΩ
Contact resistance R <sub>2</sub>	1.6 mΩ
Insertion/withdrawal cycles	25
Insulation resistance, neighboring positions	> 5 MΩ

### Climatic test

Specification	ISO 6988:1985-02
Corrosive stress	0.2 dm <sup>3</sup> SO <sub>2</sub> on 300 dm <sup>3</sup> /40 °C/1 cycle
Thermal stress	100 °C/168 h
Power-frequency withstand voltage	1.39 kV

### Ambient conditions

Ambient temperature (operation)	-40 °C ... 100 °C (dependent on the derating curve)
Ambient temperature (storage/transport)	-40 °C ... 70 °C
Relative humidity (storage/transport)	30 % ... 70 %
Ambient temperature (assembly)	-5 °C ... 100 °C

## Electrical tests

### Thermal test | Test group C

Specification	IEC 60512-5-1:2002-02
Tested number of positions	20

### Insulation resistance

# FMC 1,5/ 5-ST-3,5 - Printed-circuit board connector



1952296

<https://www.phoenixcontact.com/us/products/1952296>

Specification	IEC 60512-3-1:2002-02
Insulation resistance, neighboring positions	> 5 MΩ

## Air clearances and creepage distances |

Specification	IEC 60664-1:2007-04
Insulating material group	I
Comparative tracking index (IEC 60112)	CTI 600
Rated insulation voltage (III/3)	160 V
Rated surge voltage (III/3)	2.5 kV
minimum clearance value - non-homogenous field (III/3)	1.5 mm
minimum creepage distance (III/3)	2 mm
Rated insulation voltage (III/2)	160 V
Rated surge voltage (III/2)	2.5 kV
minimum clearance value - non-homogenous field (III/2)	1.5 mm
minimum creepage distance (III/2)	1.5 mm
Rated insulation voltage (II/2)	320 V
Rated surge voltage (II/2)	2.5 kV
minimum clearance value - non-homogenous field (II/2)	1.5 mm
minimum creepage distance (II/2)	1.6 mm

## Packaging specifications

Type of packaging	packed in cardboard
-------------------	---------------------

## Drawings

Diagram

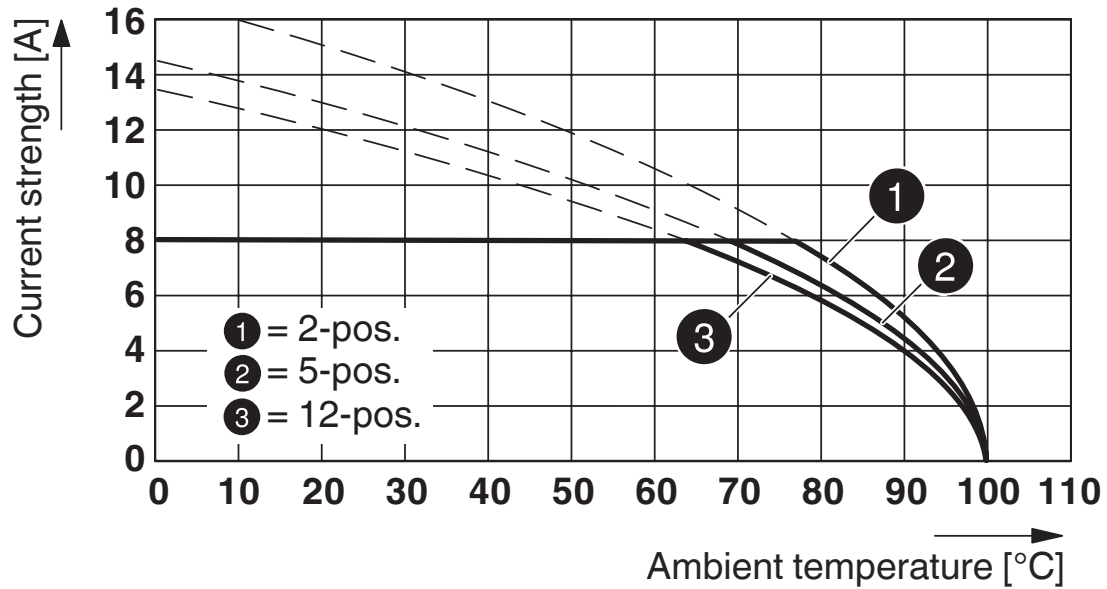

Type: FMC 1,5/...-ST-3,5 with IFMC 1,5/...-ST-3,5

Diagram

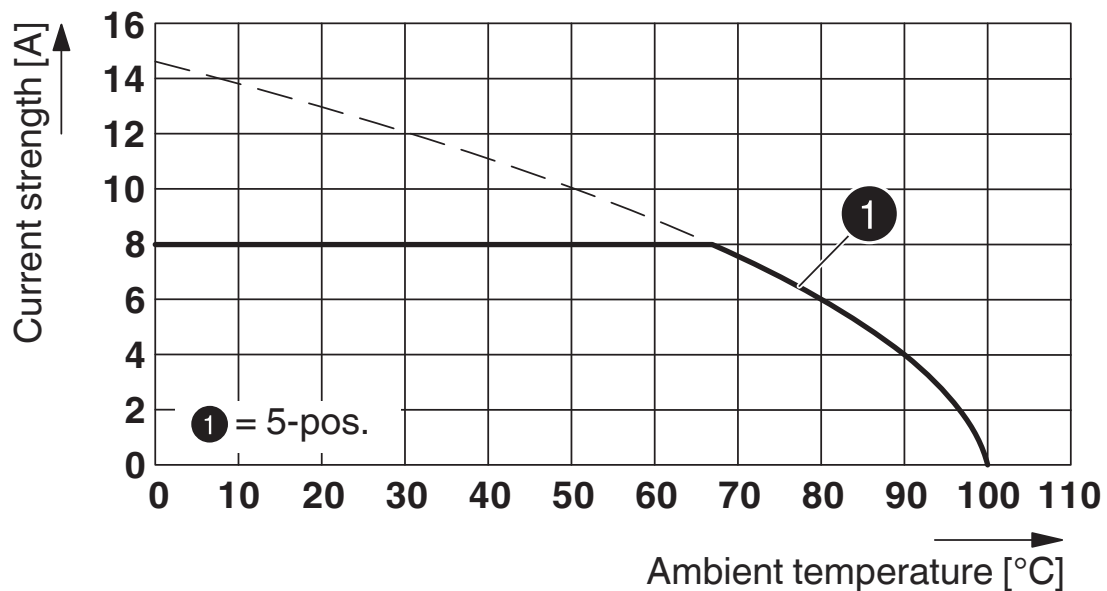

Type: FMC 1,5/...-ST-3,5 with MCD 1,5/...-G3-3,5 P26 THR MAG

# FMC 1,5/ 5-ST-3,5 - Printed-circuit board connector



1952296

<https://www.phoenixcontact.com/us/products/1952296>

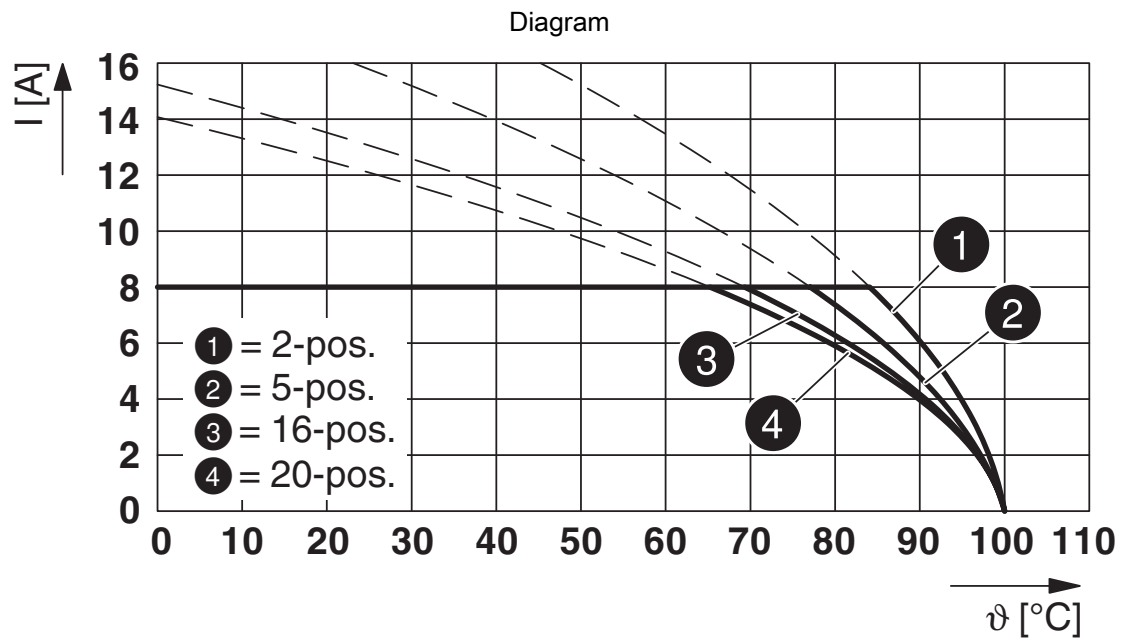

Type: FMC 1,5/...-ST-3,5 with MCV 1,5/...-G-3,5 THT

## Dimensional drawing

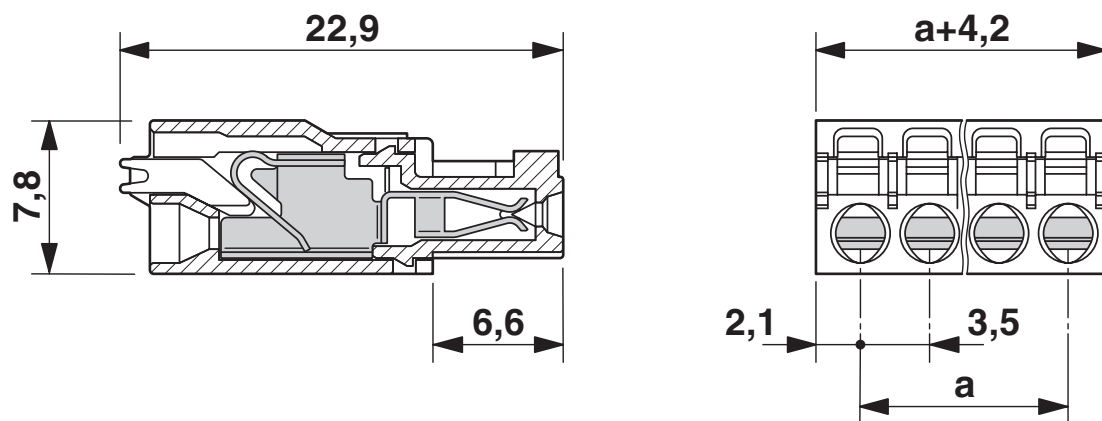



# FMC 1,5/ 5-ST-3,5 - Printed-circuit board connector



1952296

<https://www.phoenixcontact.com/us/products/1952296>

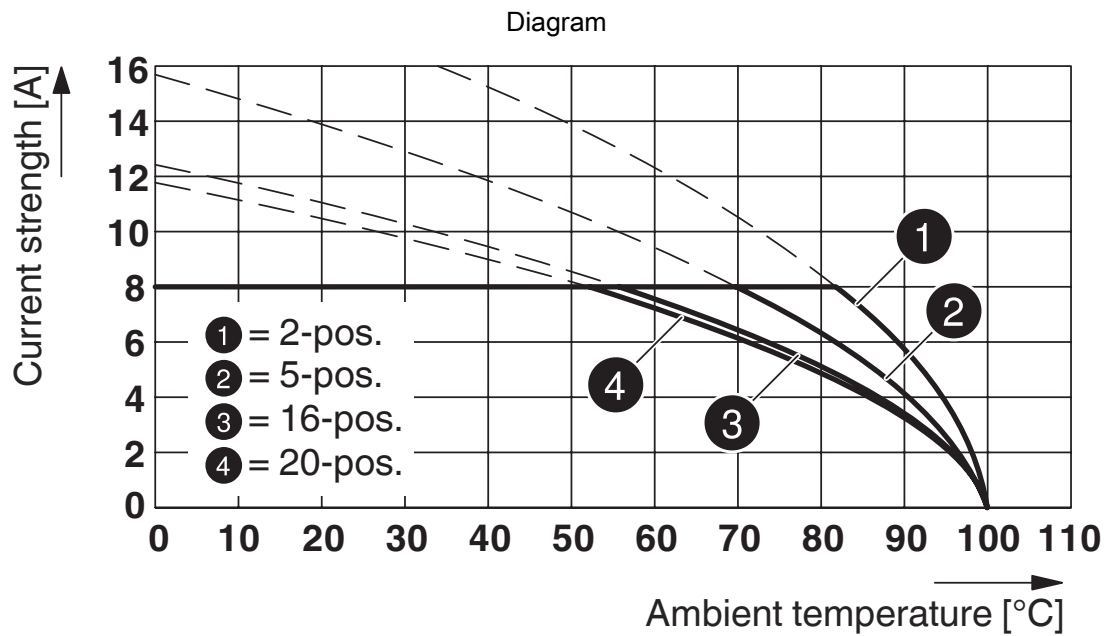

Type: FMC 1,5/...-ST-3,5 with MCDNV 1,5/...-G1-3,5 P...THR

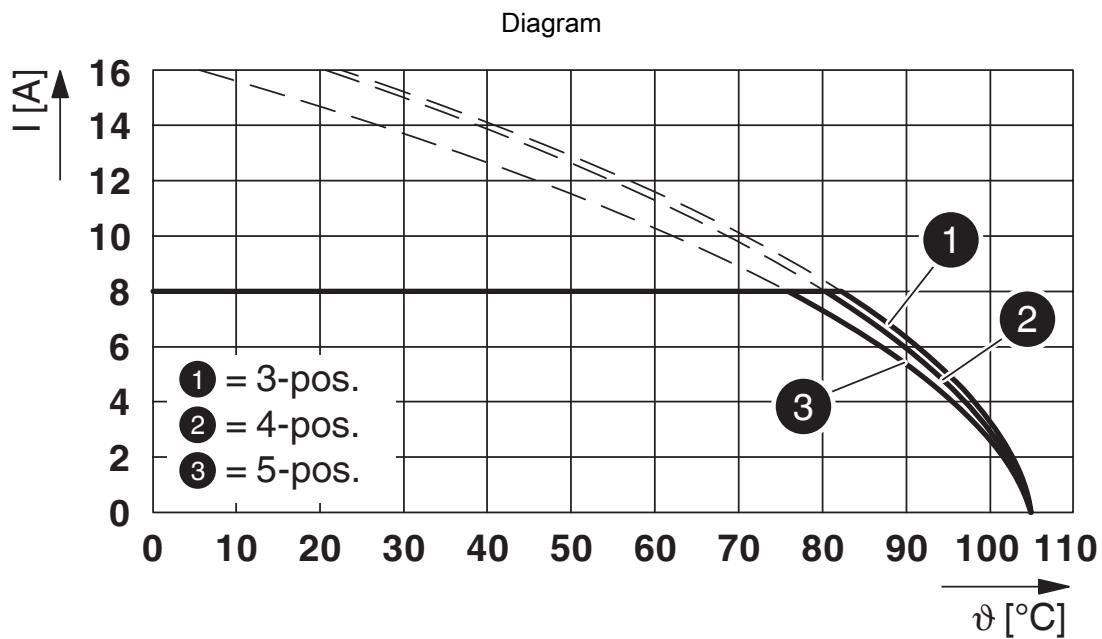

Type: FMC 1.5/...-ST-3.5 with MCO 1.5/...-G1L-3.5 KMGY

# FMC 1,5/ 5-ST-3,5 - Printed-circuit board connector



1952296

<https://www.phoenixcontact.com/us/products/1952296>

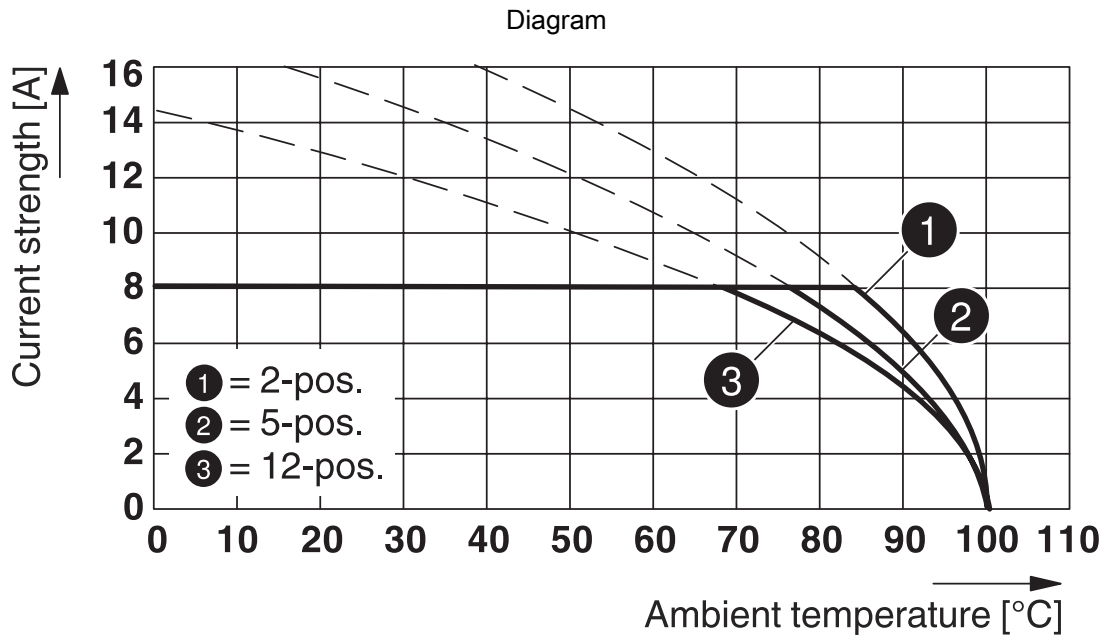

Type: FMC 1,5/...-ST-3,5 with MC 1,5/...-G-3,5 P... THR

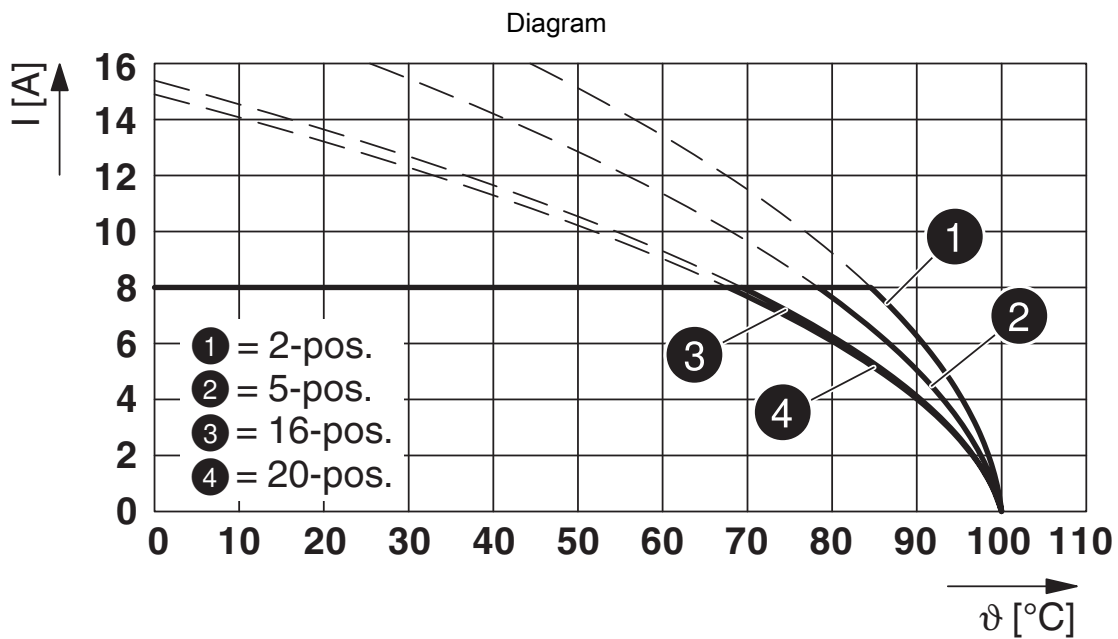

Type: FMC 1,5/...-ST-3,5 with MCV 1,5/...-G-3,5

# FMC 1,5/ 5-ST-3,5 - Printed-circuit board connector



1952296

<https://www.phoenixcontact.com/us/products/1952296>

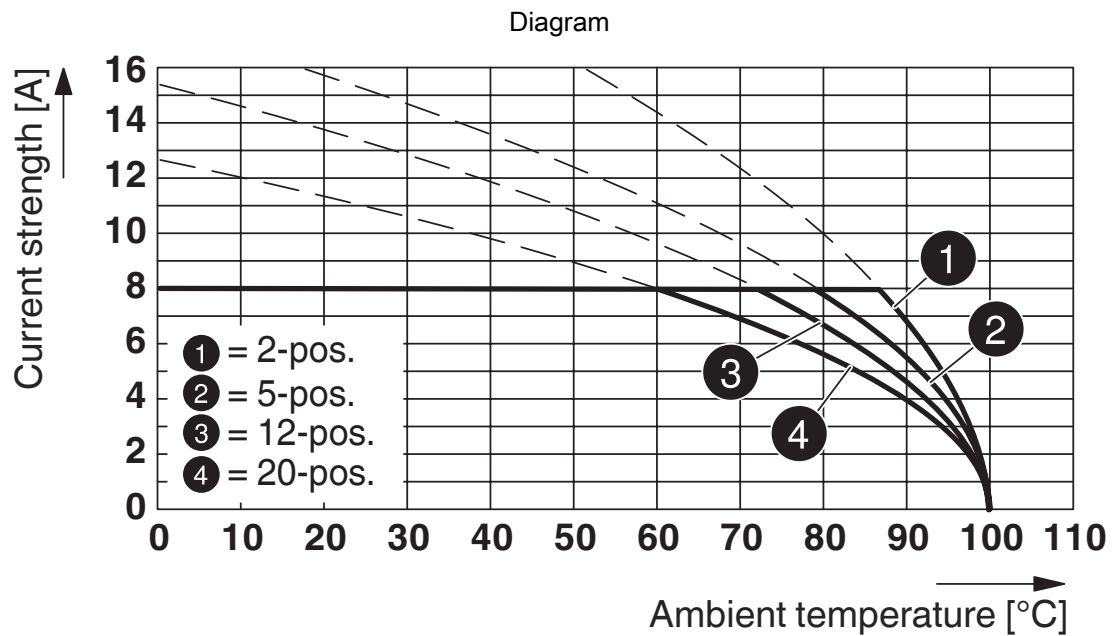

Type: FMC 1,5/...-ST-3,5 with MCV 1,5/...-G-3,5 P... THR

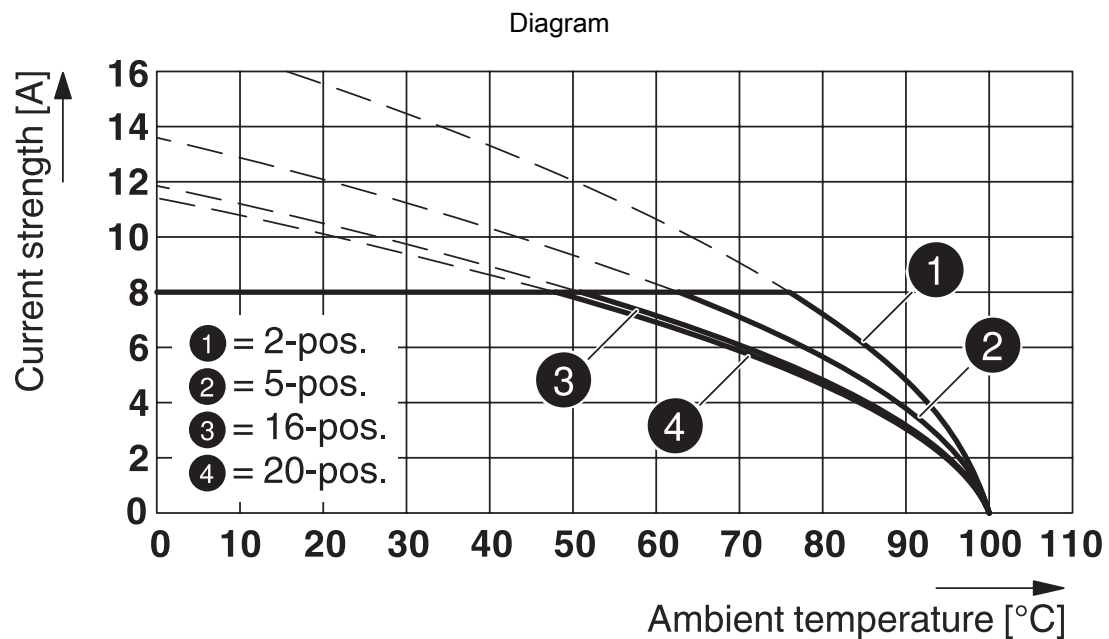

Type: FMC 1,5/...-ST-3,5 with MCDN 1,5/...-G1-3,5 P26THR

# FMC 1,5/ 5-ST-3,5 - Printed-circuit board connector





1952296

<https://www.phoenixcontact.com/us/products/1952296>

## Approvals

To download certificates, visit the product detail page: <https://www.phoenixcontact.com/us/products/1952296>

 <b>cULus Recognized</b> Approval ID: E60425-19920306				
	Nominal voltage $U_N$	Nominal current $I_N$	Cross section AWG	Cross section $\text{mm}^2$
Use group B				
Field wiring	150 V	8 A	24 - 16	-
Use group C				
Factory wiring	50 V	8 A	24 - 16	-

 <b>VDE Zeichengenehmigung</b> Approval ID: 40011723				
	Nominal voltage $U_N$	Nominal current $I_N$	Cross section AWG	Cross section $\text{mm}^2$
	160 V	8 A	-	0.2 - 1.5

# FMC 1,5/ 5-ST-3,5 - Printed-circuit board connector



1952296

<https://www.phoenixcontact.com/us/products/1952296>

## Classifications

### ECLASS

ECLASS-11.0	27460202
ECLASS-12.0	27460202
ECLASS-13.0	27460202

### ETIM

ETIM 9.0	EC002638
----------	----------

### UNSPSC

UNSPSC 21.0	39121400
-------------	----------

# FMC 1,5/ 5-ST-3,5 - Printed-circuit board connector



1952296

<https://www.phoenixcontact.com/us/products/1952296>

## Environmental product compliance

China RoHS	Environmentally friendly use period: unlimited = EFUP-e
	No hazardous substances above threshold values

# FMC 1,5/ 5-ST-3,5 - Printed-circuit board connector



1952296

<https://www.phoenixcontact.com/us/products/1952296>

## Accessories

### SK 3,5/2,8:FORTL.ZAHLEN - Marker card

0804073

<https://www.phoenixcontact.com/us/products/0804073>



Marker card, Sheet, white, labeled, horizontal: consecutive numbers 1 ... 10, 11 .. 20, etc. up to 91 ... 99, mounting type: adhesive, for terminal block width: 3.5 mm, lettering field size: 3.5 x 2.8 mm, Number of individual labels: 14

---

### B-STIFT - Marker pen

1051993

<https://www.phoenixcontact.com/us/products/1051993>



Marker pen, for manual labeling of unprinted Zack strips, smear-proof and waterproof, line thickness 0.5 mm

# FMC 1,5/ 5-ST-3,5 - Printed-circuit board connector



1952296

<https://www.phoenixcontact.com/us/products/1952296>

## CRIMPFOX 6 - Crimping pliers

1212034

<https://www.phoenixcontact.com/us/products/1212034>



Crimping pliers, for ferrules without insulating collar according to DIN 46228 Part 1 and ferrules with insulating collar according to DIN 46228 Part 4, 0.25 mm<sup>2</sup> ... 6.0 mm<sup>2</sup>, lateral entry, trapezoidal crimp

---

## SZS 0,4X2,5 VDE - Screwdriver

1205037

<https://www.phoenixcontact.com/us/products/1205037>



Screwdriver, slot-headed, VDE insulated, size: 0.4 x 2.5 x 80 mm, 2-component grip, with non-slip grip



# FMC 1,5/ 5-ST-3,5 - Printed-circuit board connector



1952296

<https://www.phoenixcontact.com/us/products/1952296>

## MCV 1,5/ 5-G-3,5 P20 THRR56 - PCB header

1780943

<https://www.phoenixcontact.com/us/products/1780943>

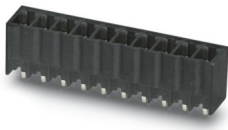

PCB headers, nominal cross section: 1.5 mm<sup>2</sup>, color: black, nominal current: 8 A, rated voltage (III/2): 160 V, contact surface: Tin, contact connection type: Pin, number of potentials: 5, number of rows: 1, number of positions: 5, number of connections: 5, product range: MCV 1,5/...-G-THR, pitch: 3.5 mm, mounting: THR soldering, pin layout: Linear pinning, solder pin [P]: 2 mm, number of solder pins per potential: 1, plug-in system: COMBICON MC 1,5, Pin connector pattern alignment: Standard, locking: without, mounting: without, type of packaging: 56 mm wide tape, For user information and design recommendations for through-hole reflow technology, go to: Downloads

## MC 1,5/ 5-G-3,5 P26 THR - PCB header

1788563

<https://www.phoenixcontact.com/us/products/1788563>



PCB headers, nominal cross section: 1.5 mm<sup>2</sup>, color: black, nominal current: 8 A, rated voltage (III/2): 160 V, contact surface: Tin, contact connection type: Pin, number of potentials: 5, number of rows: 1, number of positions: 5, number of connections: 5, product range: MC 1,5/...-G-THR, pitch: 3.5 mm, mounting: THR soldering, pin layout: Linear pinning, solder pin [P]: 2.6 mm, number of solder pins per potential: 1, plug-in system: COMBICON MC 1,5, Pin connector pattern alignment: Standard, locking: without, mounting: without, type of packaging: packed in cardboard

# FMC 1,5/ 5-ST-3,5 - Printed-circuit board connector



1952296

<https://www.phoenixcontact.com/us/products/1952296>

## MCDN 1,5/ 5-G1-3,5 P14THR - PCB header

1953949

<https://www.phoenixcontact.com/us/products/1953949>

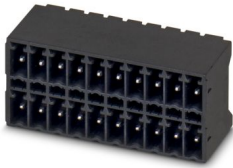

PCB headers, nominal cross section: 1.5 mm<sup>2</sup>, color: black, nominal current: 8 A, rated voltage (III/2): 160 V, contact surface: Tin, contact connection type: Pin, number of potentials: 10, number of rows: 2, number of positions: 5, number of connections: 10, product range: MCDN 1,5/...-G1-THR, pitch: 3.5 mm, mounting: THR soldering, pin layout: Linear pinning, solder pin [P]: 1.4 mm, number of solder pins per potential: 1, plug-in system: COMBICON MC 1,5, Pin connector pattern alignment: Standard, locking: without, mounting: without, type of packaging: packed in cardboard, The pin length is 1.4 mm. User information and design recommendations on Through Hole Reflow Technology can be found at: Downloads".

## MCO 1,5/ 5-G1R-3,5 KMGY - PCB header

2278351

<https://www.phoenixcontact.com/us/products/2278351>



PCB headers, nominal cross section: 1.5 mm<sup>2</sup>, color: light grey, nominal current: 8 A, rated voltage (III/2): 160 V, contact surface: Tin, contact connection type: Pin, number of potentials: 5, number of rows: 1, number of positions: 5, number of connections: 5, product range: MCO 1,5/...-G1R, pitch: 3.5 mm, mounting: Wave soldering, pin layout: Linear pinning, solder pin [P]: 2 mm, locking: without, type of packaging: packed in cardboard, Product with pin output on right side

# FMC 1,5/ 5-ST-3,5 - Printed-circuit board connector



1952296

<https://www.phoenixcontact.com/us/products/1952296>

## MCO 1,5/ 5-G1L-3,5 KMGY - PCB header

2278380

<https://www.phoenixcontact.com/us/products/2278380>



PCB headers, nominal cross section: 1.5 mm<sup>2</sup>, color: light grey, nominal current: 8 A, rated voltage (III/2): 160 V, contact surface: Tin, contact connection type: Pin, number of potentials: 5, number of rows: 1, number of positions: 5, number of connections: 5, product range: MCO 1,5/...-G1L, pitch: 3.5 mm, mounting: Wave soldering, pin layout: Linear pinning, solder pin [P]: 2 mm, locking: without, type of packaging: packed in cardboard, Product with pin output on left side

---

Phoenix Contact 2024 © - all rights reserved

<https://www.phoenixcontact.com>

Phoenix Contact USA  
586 Fulling Mill Road  
Middletown, PA 17057, United States  
(+717) 944-1300  
[info@phoenixcon.com](mailto:info@phoenixcon.com)