



# Long-range Inductive Sensors with IO-Link Interface

Catalog Numbers 871TM-MxxNP8-xx, 871TM-NxxNP8-xx,  
871TM-MxxNP18-xx, 871TM-NxxNP18-xx, 871TM-MxxNP12-xx,  
871TM-NxxNP12-xx, 871TM-MxxNP30-xx, 871TM-NxxNP30xx



***Allen-Bradley***

by **ROCKWELL AUTOMATION**

User Manual

Original Instructions

## Important User Information

Read this document and the documents listed in the additional resources section about installation, configuration, and operation of this equipment before you install, configure, operate, or maintain this product. Users are required to familiarize themselves with installation and wiring instructions in addition to requirements of all applicable codes, laws, and standards.

Activities including installation, adjustments, putting into service, use, assembly, disassembly, and maintenance are required to be carried out by suitably trained personnel in accordance with applicable code of practice.

If this equipment is used in a manner not specified by the manufacturer, the protection provided by the equipment may be impaired.

In no event will Rockwell Automation, Inc. be responsible or liable for indirect or consequential damages resulting from the use or application of this equipment.

The examples and diagrams in this manual are included solely for illustrative purposes. Because of the many variables and requirements associated with any particular installation, Rockwell Automation, Inc. cannot assume responsibility or liability for actual use based on the examples and diagrams.

No patent liability is assumed by Rockwell Automation, Inc. with respect to use of information, circuits, equipment, or software described in this manual.

Reproduction of the contents of this manual, in whole or in part, without written permission of Rockwell Automation, Inc., is prohibited.

Throughout this manual, when necessary, we use notes to make you aware of safety considerations.



**WARNING:** Identifies information about practices or circumstances that can cause an explosion in a hazardous environment, which may lead to personal injury or death, property damage, or economic loss.

---



**ATTENTION:** Identifies information about practices or circumstances that can lead to personal injury or death, property damage, or economic loss. Attentions help you identify a hazard, avoid a hazard, and recognize the consequence.

---

**IMPORTANT** Identifies information that is critical for successful application and understanding of the product.

---

Labels may also be on or inside the equipment to provide specific precautions.



**SHOCK HAZARD:** Labels may be on or inside the equipment, for example, a drive or motor, to alert people that dangerous voltage may be present.

---



**BURN HAZARD:** Labels may be on or inside the equipment, for example, a drive or motor, to alert people that surfaces may reach dangerous temperatures.

---



**ARC FLASH HAZARD:** Labels may be on or inside the equipment, for example, a motor control center, to alert people to potential Arc Flash. Arc Flash will cause severe injury or death. Wear proper Personal Protective Equipment (PPE). Follow ALL Regulatory requirements for safe work practices and for Personal Protective Equipment (PPE).

---

	<b>Preface</b>	
	Summary of Changes.....	7
	Abbreviations.....	7
	Additional Resources.....	7
	<b>Chapter 1</b>	
<b>Product Overview</b>	Product Description.....	9
	Operating Modes.....	9
	Features.....	10
	Specifications.....	10
	Correction Factors.....	11
	<b>Chapter 2</b>	
<b>Installation</b>	User Interface.....	13
	Mounting.....	13
	Dimensions.....	14
	Cable Style.....	14
	Micro QD Style.....	14
	Pico QD Style — 3-pin.....	15
	Pico QD Style — 4-pin.....	15
	Wiring.....	15
	<b>Chapter 3</b>	
<b>871TM Long-range Sensor with IO-Link Overview</b>	What Is IO-Link?.....	17
	Why IO-Link?.....	17
	Seamless Integration.....	17
	Real-time Diagnostics and Trending.....	17
	Sensor Health Status.....	18
	Device Profiles and Automatic Device Configuration.....	18
	Descriptive Tags.....	18
	How Does IO-Link Work?.....	18
	Transmission Rates.....	18
	Transmission Quality.....	19
	Response Time of the IO-Link System.....	19
	IO-Link Data Types.....	19
	Process Data.....	19
	Value Status.....	19
	Device Data.....	20
	Events.....	20
	Access IO-Link Data.....	20
	Cyclic Data.....	20
	Acyclic Data.....	20
	Start-up the I/O System.....	20
	Assign Device Parameters.....	21
	Rockwell Automation Solution.....	21

	Premier Integration . . . . .	22
	871TM Sensor IO-Link Features . . . . .	23
	Correlation . . . . .	23
	Automatic Device Configuration (ADC) . . . . .	24
	Tag Naming for I/O Data . . . . .	24
	<b>Chapter 4</b>	
<b>Configure the 871TM Sensor for IO-Link Mode</b>	Hardware . . . . .	25
	Software . . . . .	25
	Example: Set up the Hardware . . . . .	26
	<b>Chapter 5</b>	
<b>Create a Project</b>	Project Creation . . . . .	27
	<b>Chapter 6</b>	
<b>Configure the IO-Link Master</b>	Configuration Procedure . . . . .	31
	AOP Installation . . . . .	34
	<b>Chapter 7</b>	
<b>Connect the 871TM to the IO-Link Master</b>	Connection Procedure . . . . .	35
	<b>Chapter 8</b>	
<b>Register the 871TM IODD</b>	Registration Procedure . . . . .	41
	<b>Chapter 9</b>	
<b>Review the 1734-4IOL IO-Link Add-on Profile</b>	Overview . . . . .	49
	Device Parameter Behavior . . . . .	49
	Common Tab . . . . .	50
	Identification Tab . . . . .	51
	Parameter Tab . . . . .	51
	Polarity . . . . .	52
	Switching Timer Mode . . . . .	52
	Diagnosis Tab . . . . .	54
	Controller Tags . . . . .	55
	<b>Chapter 10</b>	
<b>Configure the Sensor with the Studio 5000 Environment</b>	Sample Code . . . . .	57
	Operation . . . . .	61
	Read the 871TM Configuration Via Explicit Message . . . . .	61
	Decipher the Data . . . . .	62
	Write a New Configuration to the 871TM Via Explicit Message . . . . .	63
	Reset the Sensor to Default . . . . .	67
	<b>Chapter 11</b>	
<b>Troubleshooting</b>	Checklist . . . . .	69

<b>Install the Add-on Profile</b>	<p><b>Appendix A</b></p> <p>Introduction..... 71</p> <p>Perform the Installation ..... 71</p>
<b>Device Parameters</b>	<p><b>Appendix B</b></p> <p>Identification..... 77</p> <p>Parameter..... 77</p> <p>Diagnosis ..... 78</p> <p>Process Data..... 78</p>
<b>Error Codes</b>	<p><b>Appendix C</b></p> <p>Error Codes ..... 79</p> <p style="padding-left: 20px;">Location of Error Codes ..... 80</p>
	<p><b>Index</b> ..... 81</p>

**Notes:**

This manual is a reference guide for Bulletin 871™ inductive sensors with IO-Link. It describes the procedures that you use to install, configure, troubleshoot, and use these sensors. Use this manual if you are responsible for these tasks for long-range inductive sensors with IO-Link.

## Summary of Changes

This manual contains the following new and updated information:

- Updated Catalog Numbers on the front cover.
- Updated the URL for the Sample Code Library in [Sample Code on page 57](#).

## Abbreviations

The following abbreviations are used in this publication.

Abbreviation	Definition
ADC	Automatic Device Configuration
AOI	Add-on Instruction
AOP	Add-on Profile
ASN	Application-specific name
IEC	International Electrotechnical Commission
IODD	I/O device description
NEC	National Electric Code
QD	Quick disconnect
SIO	Standard I/O

## Additional Resources

These documents contain additional information concerning related products from Rockwell Automation.

Resource	Description
871™ Extended Range User Manual, publication <a href="#">871™-UM001</a>	Provides information to mount and install 871™ extended range sensors.
Industrial Automation Wiring and Grounding Guidelines, publication <a href="#">1770-4.1</a>	Provides general guidelines for installing a Rockwell Automation industrial system.
Product Certifications website, <a href="#">rok.auto/certifications</a> .	Provides declarations of conformity, certificates, and other certification details.

You can view or download publications at [rok.auto/literature](#).

**Notes:**



## Product Overview

### Product Description

The Bulletin 871™ family of inductive sensors is the result of a unique collection of enhancements—electrical and mechanical—that make these sensors the optimal solution for harsh duty applications. The machined stainless steel housing combines an unusually thick sensing face with one-piece construction. The result is a sensor that is exceptionally resistant to abrasion and impervious to fluid ingress, a feature especially crucial in applications that involve cutting fluids and chemical washdowns. The 871™ sensor boasts sensing ranges two to three times greater than standard models, and offers increased sensing distance for all metals, including copper and brass.

The IO-Link interface enables consistent communication for diagnosing and parameterizing through to the sensor level and makes the intelligence that is already integrated in every 871™ inductive sensor fully available to you. This design provides particular advantages in the service area (fault elimination, maintenance, and device replacement), during commissioning (identification, configuration, and during operation, continuous parameter monitoring, and online diagnosis). The 871™ sensor operates as a standard discrete sensor on pin four (black) or communicates via IO-Link on the same pin when connected to an IO-Link master.

### Operating Modes

The sensor can operate in two modes:

Mode	Description
Standard I/O (SIO)	The sensor default operation mode. The sensor and its output act as a standard inductive sensor without IO-Link functionality. This mode of operation is active when the sensor is connected to a digital input device such as a PLC input module, a distribution box, or an input terminal connection.
IO-Link	This mode is automatically activated when the sensor is connected to an IO-Link enabled master device. Upon entering this mode, the yellow status indicator on the sensor stays solid to indicate that IO-Link communication has successfully been established with the master. The sensor transmits parameter and diagnostic information that can be accessed via PLC process data. No user intervention is required to enable this functionality within the sensor.

## Features

- 10...30V DC operating voltage
- Stainless steel housing
- Equal sensing for both steel and aluminum
- IP68/IP69K rated
- 3-wire operation
- IO-Link communication protocol helps minimize downtime and increase productivity
- IO-Link sensors are forward/backward compatible with standard sensors: the same sensors and same cables that are used in IO-Link and non-IO-Link applications
- IO-Link provides
  - Remote detection of the health of the sensor
  - Margin status (low alarm)
  - Timer function

## Specifications

Attribute	Value
Certifications	c-UL-us Listed and CE Marked for all applicable directives
Load current	<200 mA
Capacitive load	1 mF
Leakage current	0.1 mA
Operating voltage	10...30V DC
Voltage drop	2V DC at 200 mA
Repeatability	5% at constant temperature
Hysteresis	10% typical
Protection type	False pulse, transient noise, reverse polarity, short circuit (trigger at 340 mA typical), overload
Enclosure type rating	12/18/30 barrel size: IP68/IP69K
Housing material	Stainless steel face and barrel
Connection type	Cable: 2 m (6.5 ft) length; Quick-Disconnect: 4-pin micro style
Status indicators	Yellow: Output energized/360° status indicator visibility; flashing status indicator indicates target that is located between 80...100% of rated sensing distance
Operating temperature	-25...+70 °C (-13...+158 °F)
Shock	30 g, 11 ms
Vibration	55 Hz, 1 mm amplitude, 3 planes
IO-Link	
Protocol	IO-Link V1.0
Interface type	IO-Link
Mode	COM2 (38.4 kBd)
Cycle time, min	8 ms <sup>(1)</sup>
SIO (Standard I/O)	Supported (pin 4 for either IO-Link or SIO)

(1) These products have been tested to comply with IO-Link test specification IEC 61131-9. Environmental EMC and Physical Layer testing have not been performed with the device running in IO-Link mode.

## Correction Factors

To determine the sensing distance for materials other than the standard mild steel, a correction factor is used. The correction factors are used as a general guideline for determining the de-rated sensing distance, if applicable.

**Instructions for unshielded sensor:** To determine the appropriate correction factor, use [Table 1](#). Multiply the sensor type with the target material by the sensing range to determine de-rated sensing distance, if applicable.

**Instructions for shielded sensor:** To determine the appropriate correction factor, use [Table 1](#) and [Table 2](#). In [Table 1](#), determine the appropriate correction factor based on the type and the target material. Then, in [Table 2](#), multiply the result from [Table 1](#) by the material the sensor is mounted in. This number is the final correction factor.

**Table 1 - Correction Factor**

Target Material (No Surrounding Metal)	Barrel Size and Nominal Sensing Range					
	M12		M18		M30	
	6 mm (Shielded)	10 mm (Unshielded)	10 mm (Shielded)	20 mm (Unshielded)	20 mm (Shielded)	40 mm (Unshielded)
Steel	1	1	1	1	1	1
Copper	0.85	0.8	0.8	0.9	0.9	0.9
Aluminum	1	1	1	1	1	1
Brass	1.3	1.4	1.2	1.35	1.3	1.2
Stainless Steel 1 mm/2 mm thick	0.5/0.9	<sup>(1)</sup> /0.65	0.5/0.9	0.2/0.7	0.35/0.7	<sup>(1)</sup> /0.25

(1) No detection.

**Table 2 - Surrounding Material**

Surrounding Material Type	8 mm Dia., Shielded	12 mm Dia., Shielded	18 mm Dia., Shielded	30 mm Dia., Shielded
Steel	1	0.7	0.75	0.9
Aluminum	0.9	1.15	0.9	0.7
Brass	0.9	1.05	0.75	0.6
Stainless Steel	1	0.8	0.8	1.3

The following table indicates the protrusion distance from the mounting device for the unshielded sensor face.

Unshielded Sensor Distance from Mounting Device [mm (in.)]	8 mm Dia.	12 mm Dia.	18 mm Dia.	30 mm Dia.
	Unshielded			
Steel	15 (0.59)	22 (0.87)	36 (1.41)	18 (0.71)
Aluminum	9 (0.35)	13 (0.51)	22 (0.87)	34 (1.34)
Brass	10 (0.39)	15 (0.59)	22 (0.87)	34 (1.34)
Stainless Steel	14 (0.55)	21 (0.83)	43 (1.69)	18 (0.71)

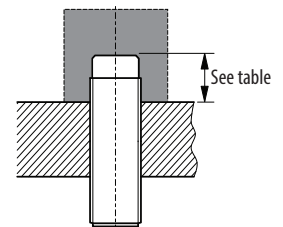

**Notes:**

## Installation

### User Interface

**Table 3 - Standard I/O Operation**

Status Indicator	State	Condition
Yellow	OFF	Output is OFF
	ON	Sensor output is triggered ON
	Blinking (margin indication)	Target is 80...100% of the maximum sensing range

**Table 4 - IO-Link Operation**

Status Indicator Color	State	Condition
Yellow	OFF	Power is OFF
	Solid	Sensor is connected to IO-Link master

### Mounting

Securely mount the sensor on a firm, stable surface, or support for reliable operation. Mounting is subject to excessive vibration or shifting could cause intermittent operation. Once securely mounted, the sensor can be wired per the wiring instructions in the next section.

You may need to adjust the sensor in the mounting due to the location of the target in relation to the sensor face. The 871TM sensor offers margin indication through the yellow status indicator. The status indicator blinks when the target is 80% of the maximum sensing distance or farther from the sensor face. It is recommended that you adjust the sensor to be closer to the target.

---

**IMPORTANT** When the sensor is connected to IO-Link, the status indicators do not indicate margin status. The margin status is shown as a process bit in the Studio 5000® controller tag.

---

# Dimensions

The following illustrations show the relevant device dimensions.

## Cable Style

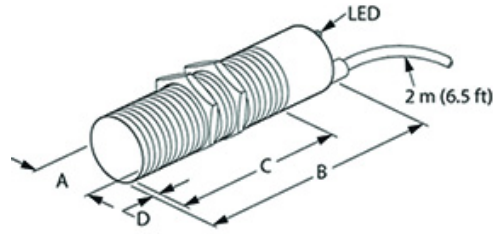

Thread Size	Shielded	[mm (in.)]			
		A	B	C	D
M8 x 1	Yes	8 (0.31)	45 (1.77)	—	—
	No			—	4 (0.16)
M12 x 1	Yes	12 (0.47)	50 (1.96)	50 (1.96)	—
	No			45 (1.77)	5 (0.19)
M18 x 1	Yes	18 (0.71)	50 (1.96)	50 (1.96)	—
	No			43 (1.69)	7 (0.27)
M30 x 1.5	Yes	30 (1.18)	50 (1.96)	50 (1.96)	—
	No			40 (1.57)	10 (0.39)

## Micro QD Style

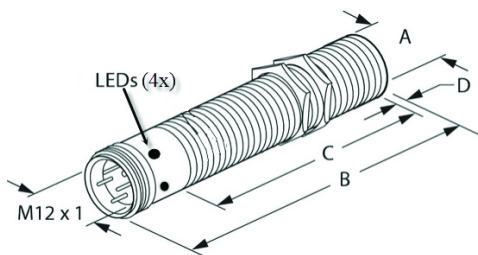

Thread Size	Shielded	[mm (in.)]			
		A	B	C	D
M8 x 1	Yes	8 (0.31)	66 (2.60)	46 (1.81)	—
	No			46 (1.81)	4 (0.16)
M12 x 1	Yes	12 (0.47)	60 (2.36)	41 (1.61)	—
	No			36 (1.42)	5 (0.19)
M18 x 1	Yes	18 (0.71)	63.5 (2.5)	42.5 (1.67)	—
	No			35.5 (1.40)	7 (0.27)
M30 x 1.5	Yes	30 (1.18)	66.3 (2.61)	42.5 (1.67)	—
	No			32.5 (1.28)	10 (0.39)

## Pico QD Style – 3-pin

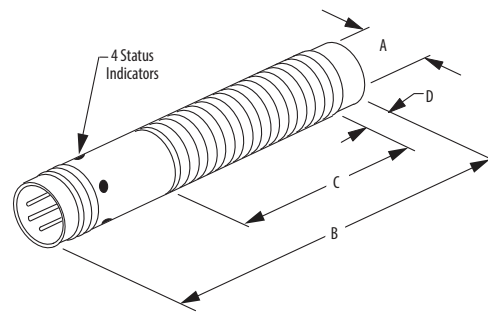

Thread Size	Shielded	[mm (in.)]			
		A	B	C	D
M8 x 1	Yes	8 (0.31)	60 (2.36)	51.5 (2.03)	–
	No	8 (0.31)	60 (2.36)	51.5 (2.03)	4 (0.16)

## Pico QD Style – 4-pin

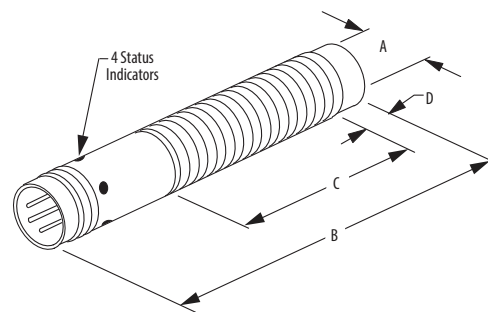

Thread Size	Shielded	[mm (in.)]			
		A	B	C	D
M8 x 1	Yes	8 (0.31)	66 (2.59)	51.5 (2.03)	–
	No	8 (0.31)	66 (2.59)	51.5 (2.03)	4 (0.16)

## Wiring

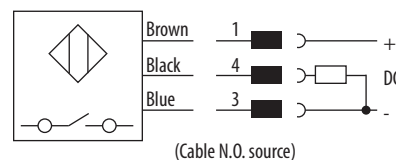

Pin	Signal	Description
1	10...30V DC	Device supply
3	GND	GND for device
4	LOAD	IO-Link/Output/SIO

We recommend the use of Bulletin 889 cordsets and patchcords for quick-disconnect (QD) model sensors. All external wiring must conform to the National Electric Code and all applicable local codes.

**Notes:**



## 871TM Long-range Sensor with IO-Link Overview

### What Is IO-Link?

IO-Link technology is an open point-to-point communication standard and was launched as (IS) IEC 61131-9. IO-Link is now the first globally standardized technology for sensor and actuator communication with a field bus system. This technology provides benefits to both OEMs and end users.

IO-Link provides communications-capable sensors to the control level by a cost-effective point-to-point connection. IO-Link provides a point-to-point link between the I/O module and sensor that is used for transferring detailed diagnostics, device identity information, process data, and parameterization.

IO-Link communication is based on a master-slave structure in which the master controls the interface access to the sensor. The option of using the intelligence that is integrated into the sensor provides you with new methods to commission your sensor. Benefits range from reduced installation time during startup to increased diagnostics over the lifetime of the machine.

Benefits of IO-Link technology include:

- Reduced inventory and operating costs
- Increased uptime/productivity
- Simplified design, installation, configuration, and maintenance
- Enhanced flexibility and scalability
- Detailed diagnostic information for preventative maintenance

### Why IO-Link?

IO-Link offers a full range of advanced features and functions.

#### Seamless Integration

- Forward and backward compatible, sensor catalog numbers remain the same
- No special cables required
- Connectivity options remain the same
- Access IO-Link functionality by simply connecting an IO-Link enabled device to an IO-Link master

#### Real-time Diagnostics and Trending

- Real-time monitoring of the entire machine down to the sensor level
- Optimized preventative maintenance—identify and correct issues before failures can occur
- Detect sensor malfunctions/failure

## Sensor Health Status

Real-time monitoring verifies that sensors are operating correctly

## Device Profiles and Automatic Device Configuration

- Golden device configurations are stored in the IO-Link master module
- Within minutes instead of hours, modify sensor parameters to produce different finished goods

## Descriptive Tags

- Faster programming during initial setup
- More efficient troubleshooting process data tags are named based on the information they provide
- Easily monitor sensor data through intuitive tag names

## How Does IO-Link Work?

IO-Link delivers data over the same standard field cabling used today. By connecting an IO-Link sensor to an IO-Link master, the field-device data and diagnostics are accessible. So, go beyond product detection on the machine—now the health of the machine can be monitored as it runs.

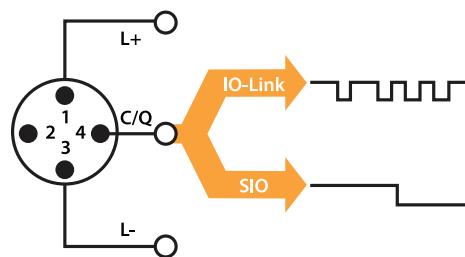

Pin	Signal	Remark
1	L+	24V
2	Out	Depends on sensor
3	L-	Ground
4	C/Q	Communication/ switching signal

**IMPORTANT** The response time of an IO-Link system may not be fast enough for high-speed applications. In this case, it may be possible to monitor/configure the sensor through IO-Link on pin 4 of the sensor while connecting pin 2 (if the sensor offers a second output) of the sensor to a standard input card.

## Transmission Rates

Three communication rates are specified for the IO-Link device:

- COM 1 = 4.8 kBd
- COM 2 = 38.4 kBd
- COM 3 = 230.4 kBd

An IO-Link device typically supports only one of the specified transmissions rates, while the IO-Link V1.1 specifications requires an IO-Link master to support all three communication rates. (See [Specifications on page 10](#) for communication rates.)

## Transmission Quality

The IO-Link communication system operates at a 24V level. If a transmission fails, the frame is repeated two more times. If the transmission fails on the second try, the IO-Link master recognizes a communication failure and signals it to the controller.

## Response Time of the IO-Link System

The device description file (IODD) of the device contains a value for the minimum cycle time of the device. This value indicates the time intervals at which the master may address the device. The value has a large influence on the response time. In addition, the master has an internal processing time that is included in the calculation of the system response time.

Devices with different minimum cycle times can be configured on one master. The response time differs accordingly for these devices. When configuring the master, you can specify a fixed cycle time and the device-specific minimum cycle time that is stored in the IODD. The master then addresses the device that is based on this specification. The typical response time for a device therefore results from the effective cycle time of the device and the typical internal processing time of the master. (See [Specifications on page 10](#) for minimum cycle time.)

## IO-Link Data Types

There are four data types available through IO-Link:

Process data	→	Cyclic data
Value status	→	Cyclic data
Device data	→	Acyclic data
Events	→	Acyclic data

## Process Data

The process data of the devices are transmitted cyclically in a data frame in which the device specifies the size of the process data. Depending on the device, 0...32 bytes of process data are possible (for each input and output). The consistency width of the transmission is not fixed and is thus dependent on the master.

Some devices can support multiple process data modes, which allow you to select different cyclic process data themes.

## Value Status

The value status indicates whether the process data is valid or invalid. The value status can be transmitted cyclically with the process data.

## Device Data

Device data supports device-specific configurable parameters, identification data, and diagnostic information. They are exchanged acyclically and at the request of the IO-Link master. Device data can be written to the device (Write) and also read from the device (Read).

## Events

When an event occurs, the device signals the presence of the event to the master. The master then reads out the event. Events can be error messages and warnings/maintenance data. Error messages are transmitted from the device to the controller via the IO-Link master. The transmission of device parameters or events occurs independently from the cyclic transmission of process data (see [Appendix C on page 79](#) for device-specific events and associated codes).

## Access IO-Link Data

### Cyclic Data

To exchange the cyclic process data between an IO-Link device and a controller, the IO-Link data from the IO-Link master is placed on the address ranges assigned beforehand. The user program on the controller accesses the process values using these addresses and processes them. The cyclic data exchange from the controller to the IO-Link device (that is, IO-Link sensor) is performed in reverse.

### Acyclic Data

Acyclic data, such as device parameters or events, are exchanged using a specified index and subindex range. The controller accesses these using Explicit Messaging. The use of the index and subindex ranges allows targeted access to the device data (that is, for reassigning the device or master parameters during operation).

## Start-up the I/O System

If the port of the master is set to IO-Link mode, the IO-Link master attempts to communicate with the connected IO-Link device. To do so, the IO-Link master sends a defined signal (wake up pulse) and waits for the IO-Link device to reply.

The IO-Link master initially attempts to communicate at the highest defined data transmission rate. If unsuccessful, the IO-Link master then attempts to communicate at the next lower data transmission rate.

If the master receives a reply, the communication begins. Next, it exchanges the communication parameters. If necessary, parameters that are saved in the system are transmitted to the device. Then, the cyclic exchange of the process data and value status begins.

## Assign Device Parameters

Configuration of a device for a specific application requires changes to parameter settings. The device parameters and setting values are contained in the IODD of the device.

I/O Device Description (IODD) files contain information about the device identity, parameters, process data, diagnostic data, and communication properties. These files are required to establish communication with the sensors via IO-Link.

The IODD consists of multiple data files; the main file and several optional language files are in XML-format and graphic files are in PNG format (portable network graphics). These files adhere to the IO-Link open standard, which means that they can be used with any IO-Link masters.

IODD files are assigned using the Studio 5000 environment and the 1734-4IOL Add-on Profile (when using the 1734-4IOL IO-Link master module).

## Rockwell Automation Solution

Rockwell Automation is the only supplier who provides every piece of the Connected Enterprise solution from top to bottom. Plus, exclusive features and Premier Integration between Allen-Bradley® components and an Integrated Architecture® system allow for a seamless connection and commission of control components. Empowering the ability to reap the benefits of an IO-Link solution with access to more detailed and customized plant-floor information than other solutions can offer.

## Premier Integration

The Studio 5000 Logix Designer® environment combines design and engineering elements in one interface, which enables you to access I/O and configuration data across the Integrated Architecture system. Use of a Rockwell Automation solution, provides a smooth, consistent integration of Allen-Bradley IO-Link enabled devices into the system.

To simplify the integration of the Allen-Bradley IO-Link devices to the Rockwell Automation architecture, there is an IO-Link Add-on Profile (AOP) available for the 1734-4IOL master module. The use of an AOP simplifies the setup of devices by providing the necessary fields in an organized manner that allows you to build and configure their systems in a quick and efficient manner.

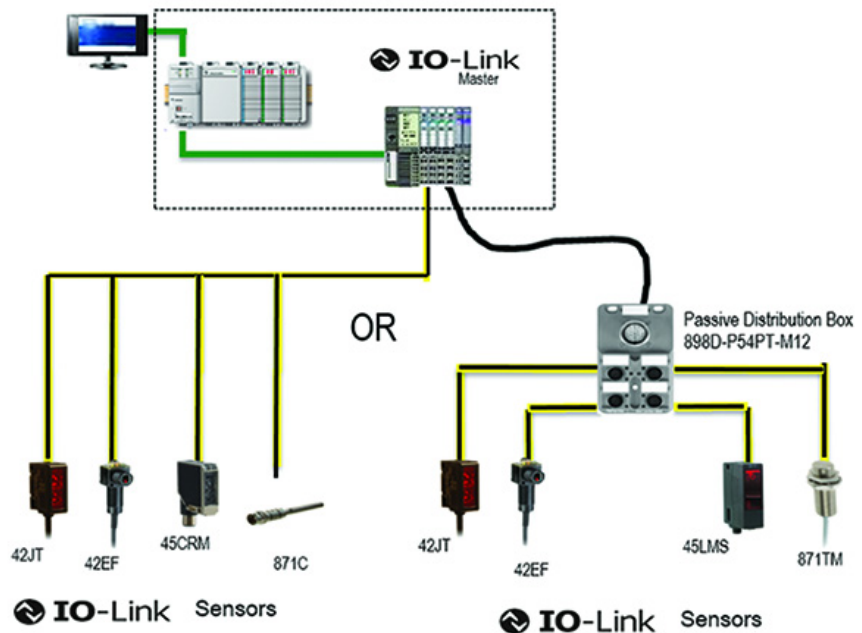
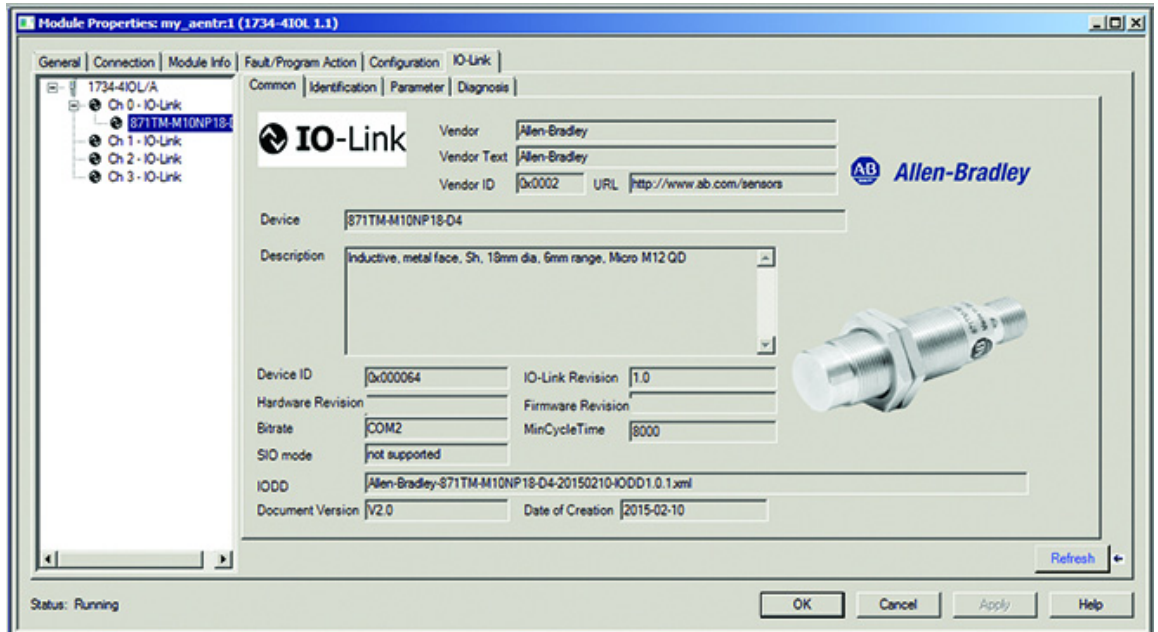

## 871TM Sensor IO-Link Features

The following features are available in the 871TM sensor:

Feature	Description
Triggered	The process data bit that communicates the change in state of the 871TM sensor upon the detection of a target. The status of the triggered bit can be viewed in a Studio 5000 controller tag.
Polarity	Changes the operation of the triggered parameter. It performs the same function as normally open or normally closed in standard I/O (SIO) mode.
Margin Status	The process data bit that communicates the target is within or beyond 80% of the maximum sensing range of the sensor. The margin status bit can be viewed in Studio 5000 controller tag.
Switching Timer Mode	Ability to manipulate the output of the sensor in relation to timing. It is useful for precision applications where the output of the needs to be precisely triggered at a certain time.

### Correlation

The AOP reads all configuration read-write (R.W.) parameters directly from the connected IO-Link devices and compares the values to ones stored in the controller. This action determines if there are differences (note that the correlation does not work for read-only (R.O.) in the parameters or for competitive sensors.). This feature is for Allen-Bradley enabled IO-Link devices only and is an online only function that runs when opening up the AOP.

- **No differences:** There are no differences, so you go directly into the AOP.
- **Differences:** If there are differences, the user is provided with a differences dialogue that identifies the IO-Link parameters that do not match for each channel. You can then choose, on a channel by channel basis (where differences exist) to upload the parameters that are currently in the device and store them in the controller. Alternatively, you can choose to download the parameters that are stored in the controller to the connected IO-Link device.

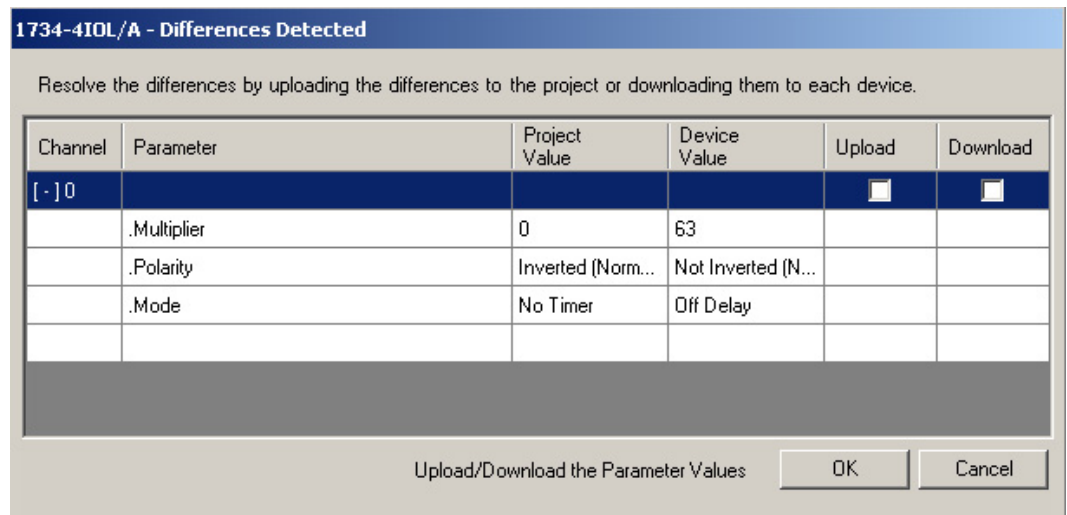

## Automatic Device Configuration (ADC)

Replacement of damaged sensors is easy. Simply remove the old Allen-Bradley sensor and connect the new sensor (with the same catalog number) — the controller automatically sends the configuration to the new sensor.

ADC capability within the sensor and controller enable flexibility and reliability in your application. When the sensor becomes damaged or fails and must be replaced, replace it with the exact same catalog number of the existing sensor. When the damaged sensor is removed and the new sensor is plugged in, the existing configuration is automatically stored in the sensor through the IO-Link Master. No additional steps are required on the sensor or in the controller. No personal computer is required and retooling the sensor is not required.

### Tag Naming for I/O Data

Rockwell Automation system solutions provide tag names that are based on the Allen-Bradley sensor connected. I/O data is converted, formatted, and named based on the Allen-Bradley sensor applied. Reduces commissioning time by the OEM and reduces troubleshooting time by the end user when searching for sensor data. Consistent naming techniques used.

42JT	My_1734_4IOL:1:I.Ch0.Triggered
	My_1734_4IOL:1:I.Ch0.MarginLowAlarm
42EF	My_1734_4IOL:1:I.Ch1.Triggered
	My_1734_4IOL:1:I.Ch1.MarginLowAlarm
45CRM	My_1734_4IOL:1:I.Ch2.Triggered
871TM	My_1734_4IOL:1:I.Ch3.Triggered
	My_1734_4IOL:1:I.Ch3.MarginStatus
45LMS	My_1734_4IOL:2:I.Ch0.Distance
	My_1734_4IOL:2:I.Ch0.Triggered1
	My_1734_4IOL:2:I.Ch0.Triggered2
	My_1734_4IOL:2:I.Ch0.MarginLevel

The Triggered and Margin Status that is previously shown are examples of consistent tag names that are used across all Allen-Bradley sensors. These tags give insightful and descriptive meaning to the operation of the sensor output. The tags may change depending on the type of sensor being used and the functionality within the sensor.



## Configure the 871TM Sensor for IO-Link Mode

This chapter shows the physical hardware and software that is required to configure the 871TM sensor through IO-Link and provides a simple guide to setting up the hardware.

The products that are required include the following hardware and software.

### Hardware

- 871TM-xx (compatible sensors are N.O. PNP) with 12 mm or 18 mm barrel diameter
- CompactLogix™ or ControlLogix® PLC Platform
- POINT I/O™ Communications Interface: 1734-AENTR
- POINT I/O IO-Link Master Module: 1734-4IOL
- POINT I/O Terminal Base: 1734-TB
- RJ45 network cable for EtherNet/IP™ connectivity: 1585J-M8TBJM-1M9xx
- 889D cordsets (optional): 889D-F3AC-2xx (IO-Link maximum acceptable cable length is 20 m [65.6 ft])

### Software

- Studio 5000® environment, version 20 and higher
- Sensor-specific IODD
- 1734-4IOL IO-Link Add-on Profile (AOP)

## Example: Set up the Hardware

In this example, a POINT I/O™ chassis is shown with a 1734-AENTR adapter and a 1734-4IOL IO-Link master module in the first slot. The 1734-AENTR adapter is communicating with a CompactLogix controller via an EtherNet/IP network.

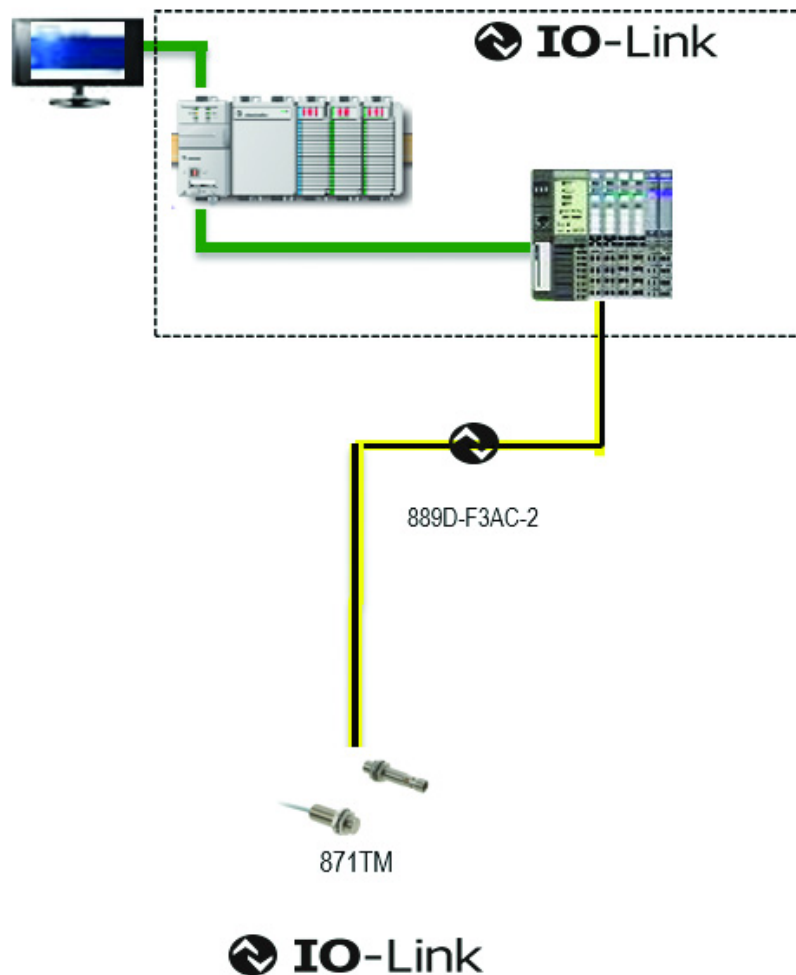

When adding a 871TM sensor to the 1734-4IOL master module, complete the following steps:

1. Provide power to the 1734-AENTR adapter.
2. Set the node address on 1734-AENTR adapter.
3. Connect the 1734-AENTR adapter to the Allen-Bradley controller with the recommended RJ45 Ethernet cable.
4. Wire the sensor cable to the desired location on the IO-Link master (in this example, we are showing the sensor that is wired to the channel 0).
5. Connect the 871TM sensor to the other end of the sensor cable.
6. After connecting the sensor, you must create/open a project in the Studio 5000 environment to establish communication with the Allen-Bradley controller that is being used. You must also add the 1734-AENTR adapter and 1734-4IOL IO-Link master module to Controller Organizer Tree (see [Chapter 6 on page 31](#) and [Chapter 7 on page 35](#) for detailed instructions).

## Create a Project

### Project Creation

To begin a new Studio 5000® project, follow the steps in this chapter.

If there is an existing project within the Studio 5000 environment with CompactLogix™ or ControlLogix® hardware that is installed and communicating online, go directly to [Chapter 6 on page 31](#).

1. Double-click the Studio 5000 environment icon.

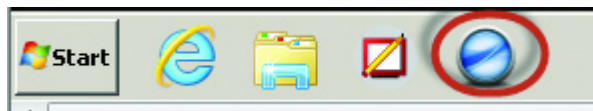

2. Click New Project.



Checking activations...

3. In the New Project dialog box, select the controller for your project, name the project, and click Next.

In this example, the project is named 1769 L24ER CompactLogix 5370 controller.

- After selecting the controller, name the project and click Next.

In this example, the project name is “Project871TM.”

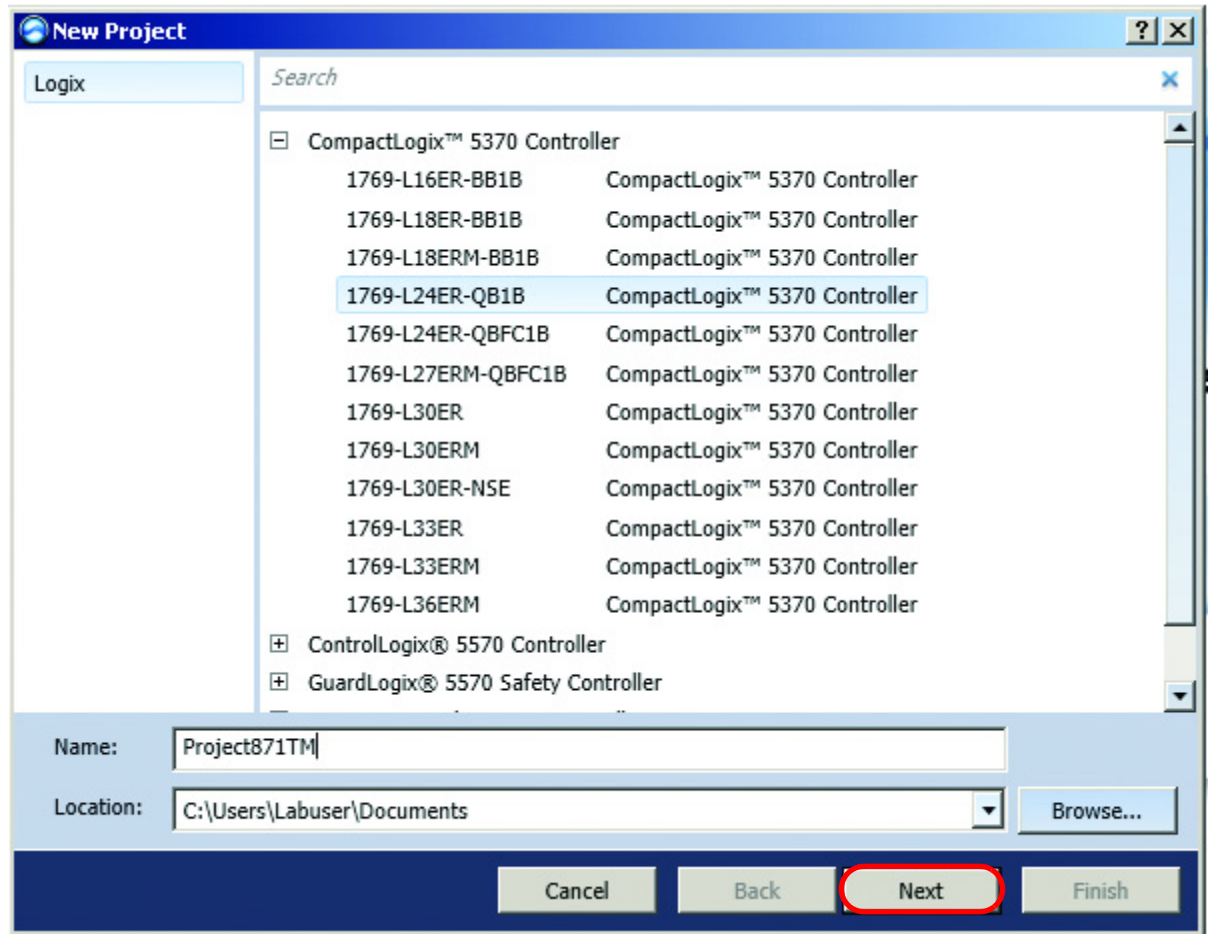

- To verify communication, set the IP address by clicking the browsing icon.

Project871TM opens.

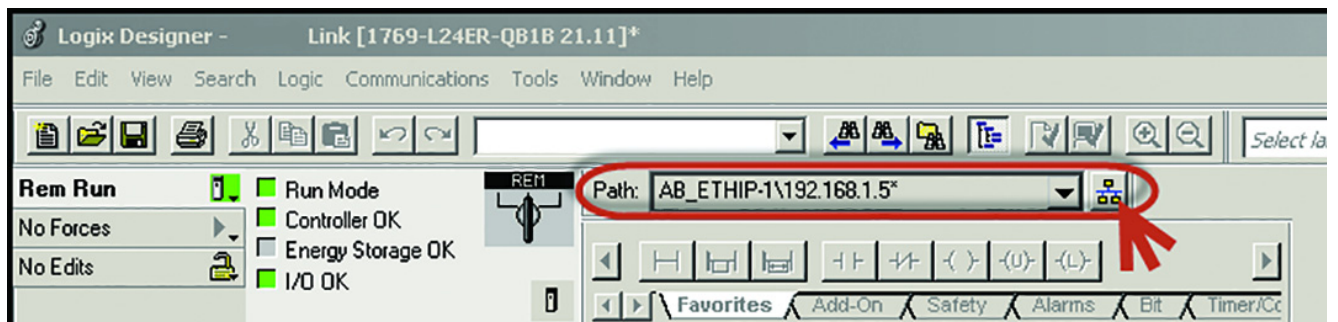

6. Select the controller that is being used for the project and click Go Online to start communication.

In this example, we are using a 1769-L24ER-QB1B CompactLogix.

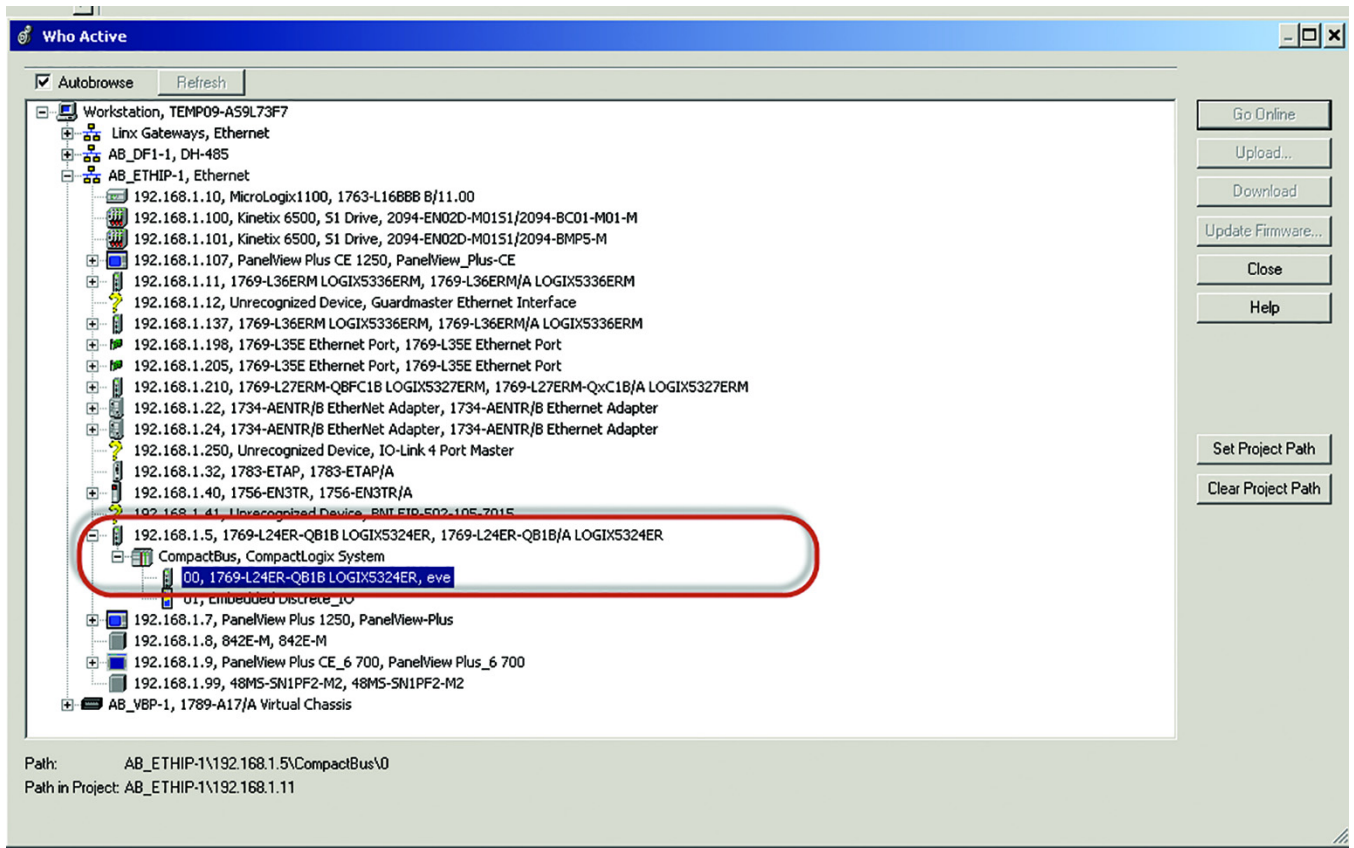

The next step is to [Configure the IO-Link Master on page 31](#).

**Notes:**

## Configure the IO-Link Master

### Configuration Procedure

1. Make sure that the controller is offline to configure the IO-Link Master.

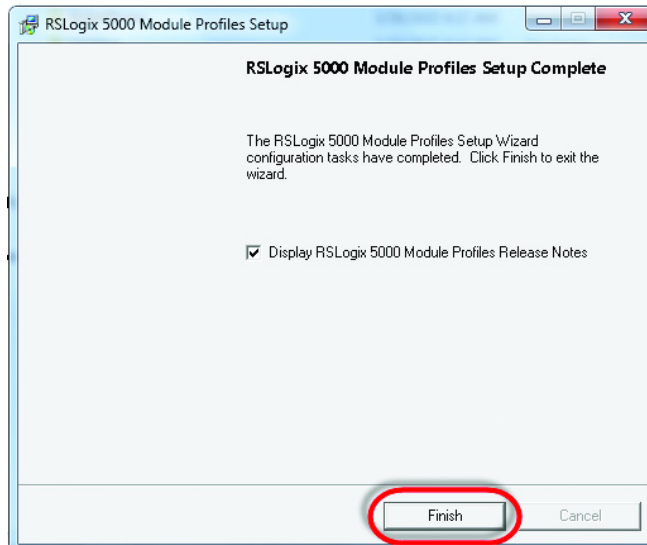

2. In the controller organizer tree, find Ethernet under I/O Configuration and right-click to add New Module.

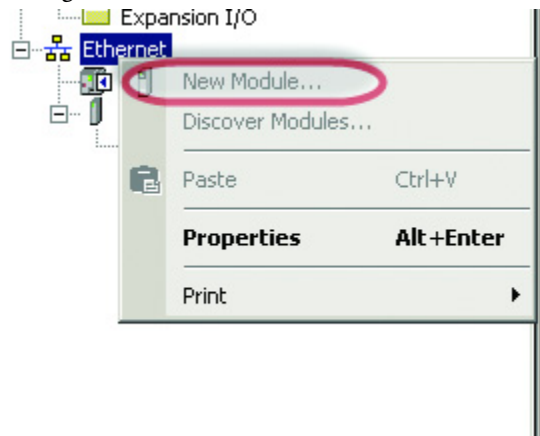

The module window pops up and shows the available modules.

3. Select the “1734-AENTR, 1734 Ethernet adapter, 2-port, twisted-pair media” and click Create.

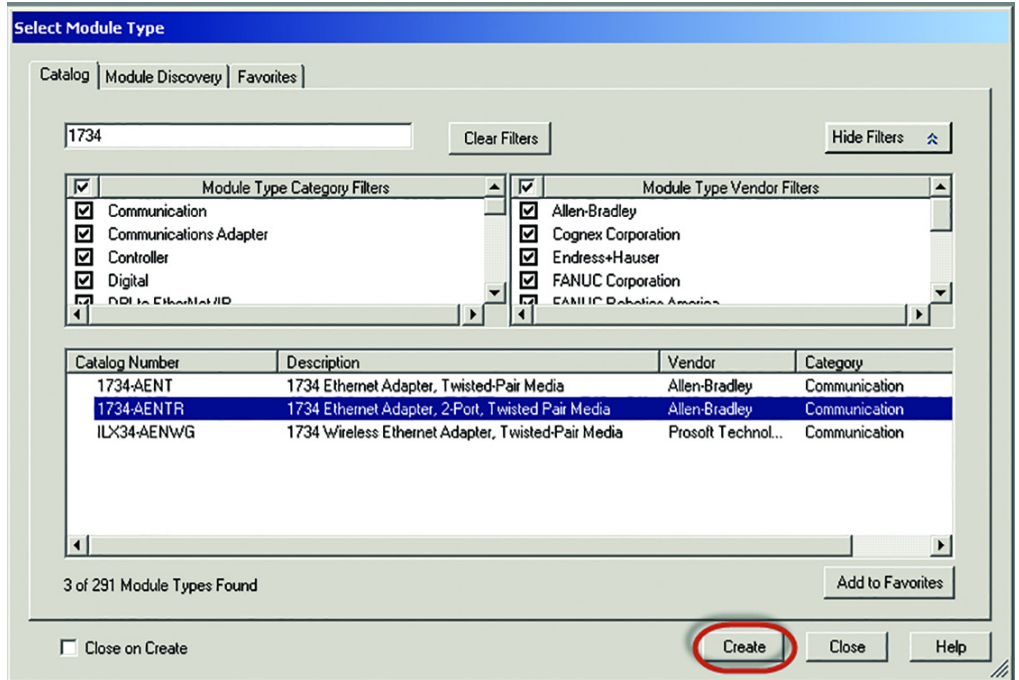

4. Name the Ethernet adapter (in this example our adapter name is “adapter”), set the chassis size, check the module revision, and configure the adapter Ethernet address. Click OK and then Close.

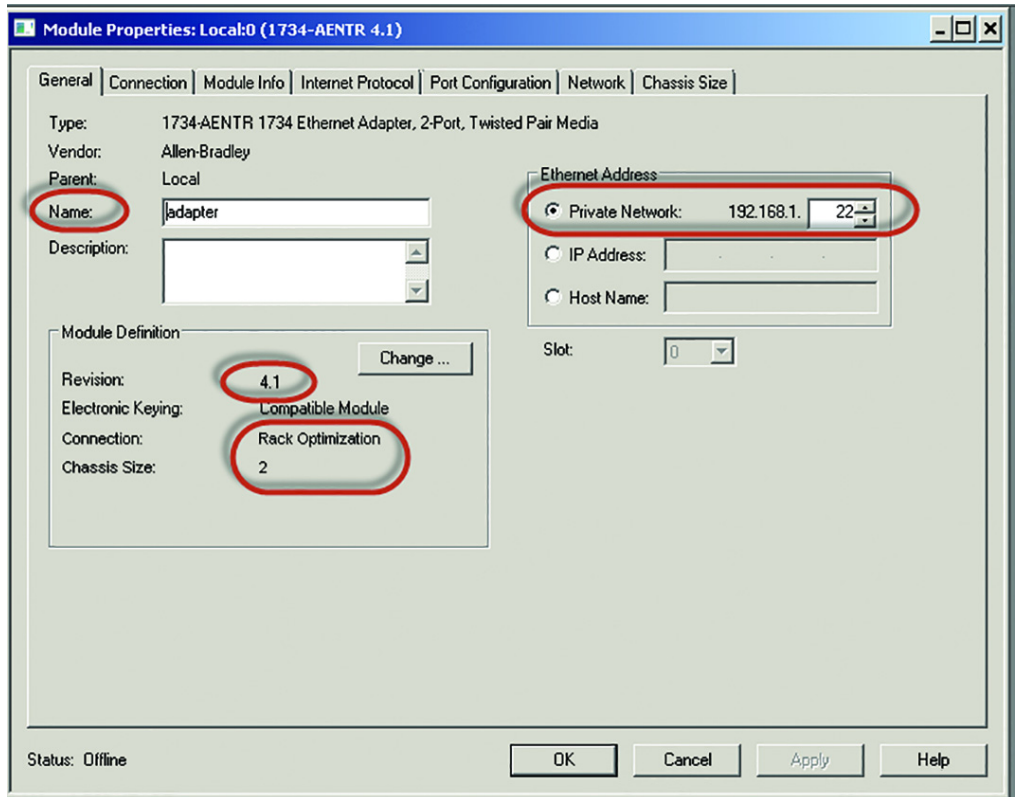



5. The 1734-AENTR adapter appears in the Controller Organizer tree.

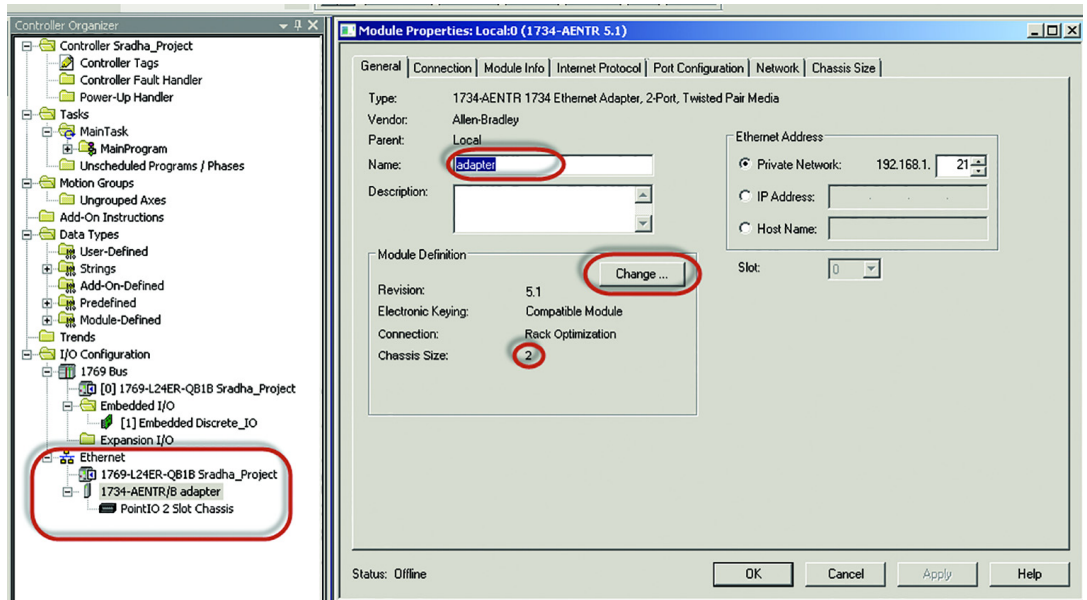

6. Right-click the 1734-AENTR/B Adapter, and click New Module.

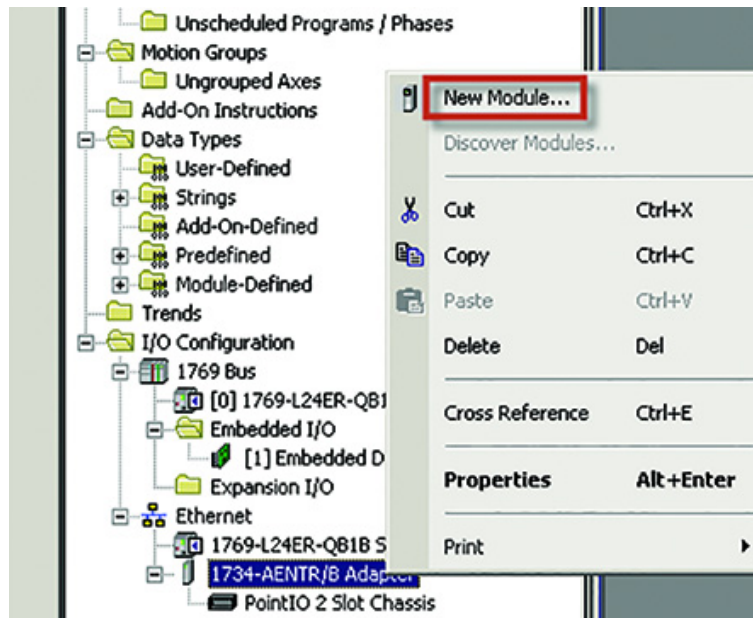

- Select “1734 IO-Link Module Profiles” and click Install.

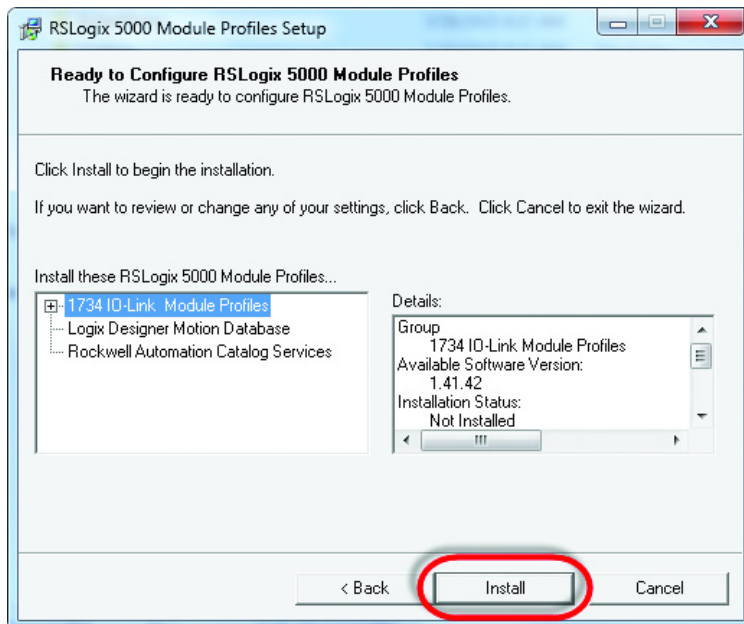

The IO-Link Configuration screen appears.

- Name the IO-Link Master and click OK.

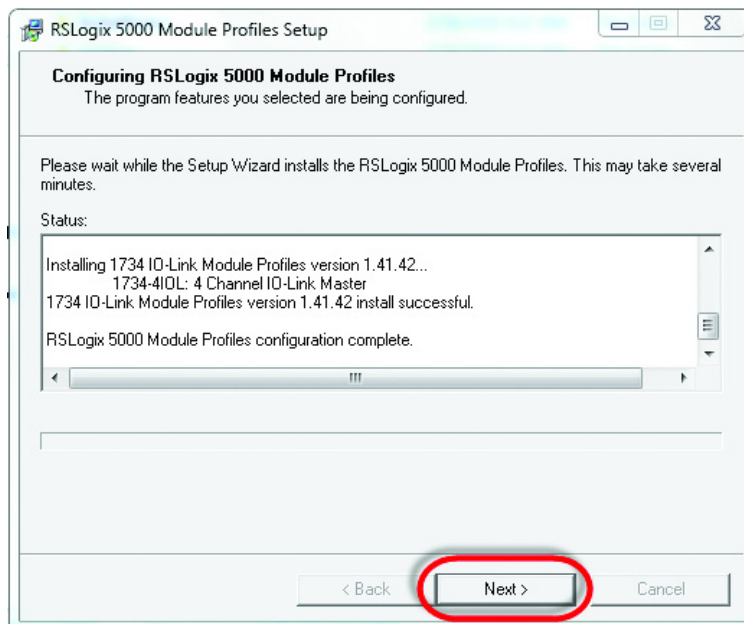

The 871™ sensor can now be configured. To configure the sensor, a sensor-specific IODD (I/O Device Description) file is required. The next steps show how to register the IODD file.

## AOP Installation

Verify that the Studio 5000® environment contains the 1734-4IOL IO-Link AOP. Version 20 or higher of Studio 5000 environment supports this module and AOP. To verify that the 1734-4IOL module is installed, verify that the 1734-AENTR adapter contains the 1734-4IOL in the library. If the AOP is required to be downloaded, see [Appendix A on page 71](#) for more information.

## Connect the 871TM to the IO-Link Master

### Connection Procedure

Once the IO-Link master is configured, connect the sensor to the IO-Link master. Take the controller offline to add a device to the IO-Link master.

1. Go to the IO-Link tab and click Change.

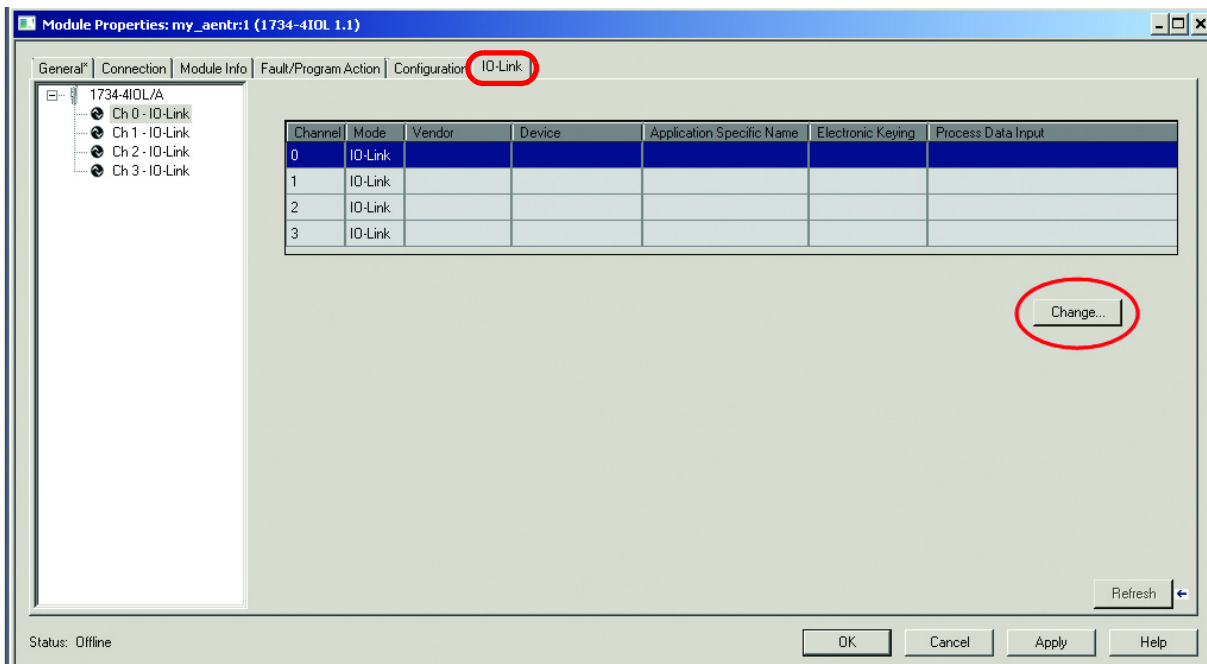

2. Choose the IO-Link channel number that you want to add a sensor to and click the Change Device column.

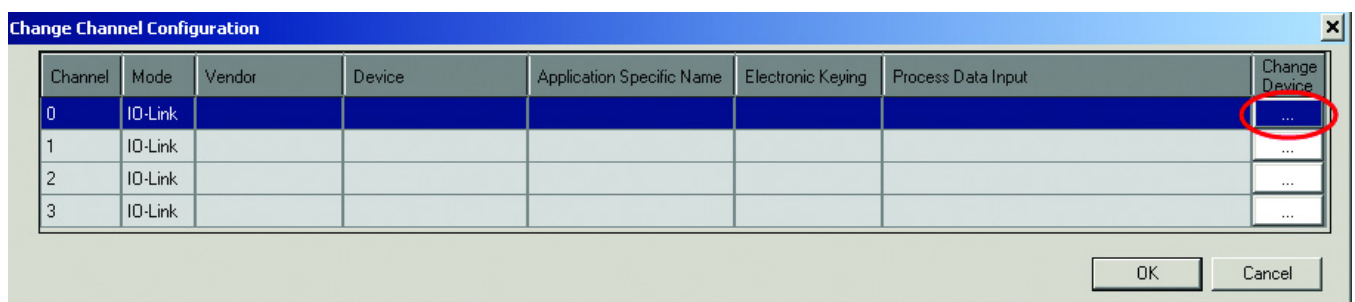

A window that contains a library of all sensors that are currently registered in the IO-Link Device Library appears.

- 3. Select the appropriate sensor and click Create.

If the sensor does not appear in the library, see [Chapter 8 on page 41](#) to learn how to Register the IODD.

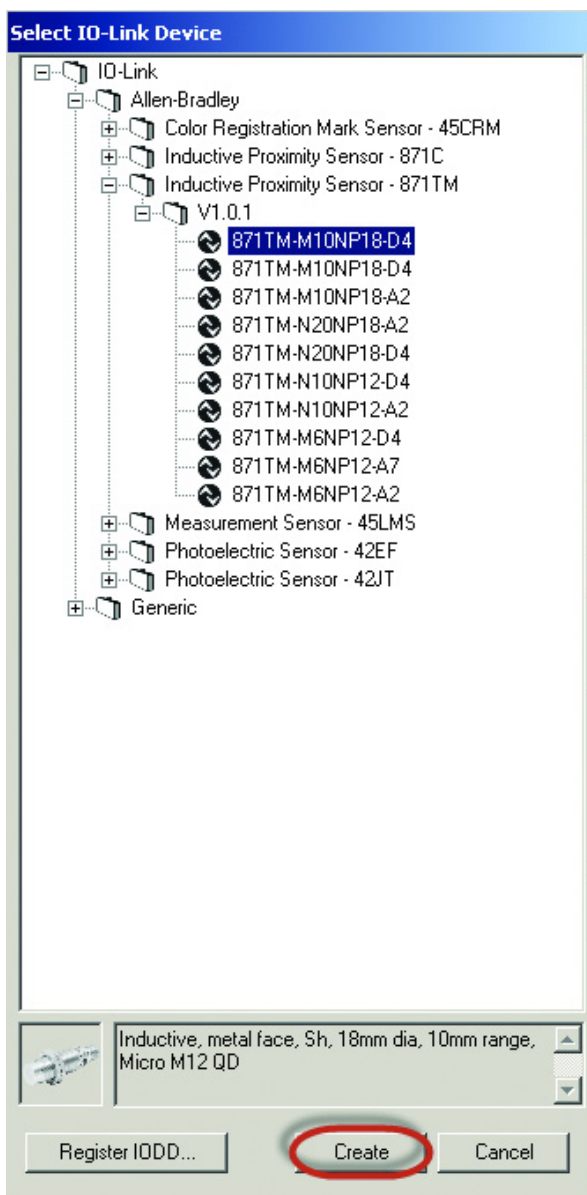

The sensor is now in the channel configuration window.

- You can change the Application Specific Name, Electronic Keying, and Process Data Input configuration while the project is in the offline mode.

---

**IMPORTANT** The 871TM IO-Link does not support Application Specific Name or Process Data Input configuration.

---

Modify the information:

- Application Specific Name (ASN):** The purpose of the Application Specific Name is to add theme naming to distinguish the sensors within a machine and the associated project profile in the Add-on Profile (AOP). The ASN allows for easier maintenance and operation since the device is further identified by how it is used on the machine/project.
- Electronic Keying Information:** Select Exact Match or Disabled from the pull-down menu. The Exact Match and Disabled keying options in this dialog correspond to the Compatible and No Check keying options in IO-Link terminology, respectively.  
When Exact Match is selected, the connected IO-Link device must have the same Vendor ID, Device ID, and Revision information that has been configured for that channel. If they do not match, IO-Link communications are not established and a Keying Fault status bit is set. When Disabled is selected, key check is not performed.
- Process Data Input:** Select the input data from the pull-down menu (for devices that support multiple layouts of input data).

Click OK.

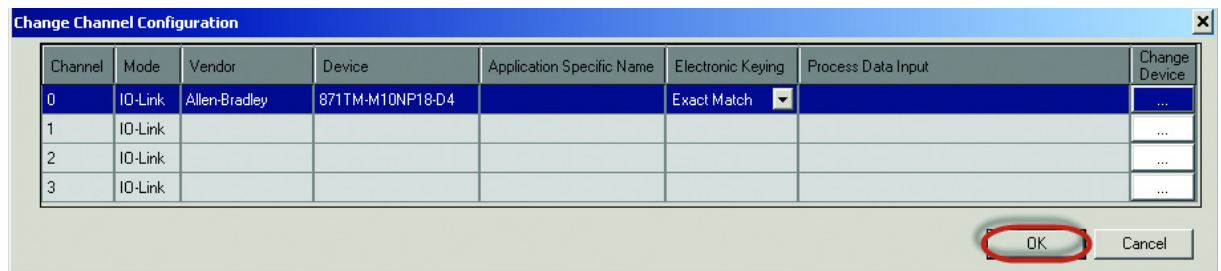

- Click Yes to confirm the sensor changes.

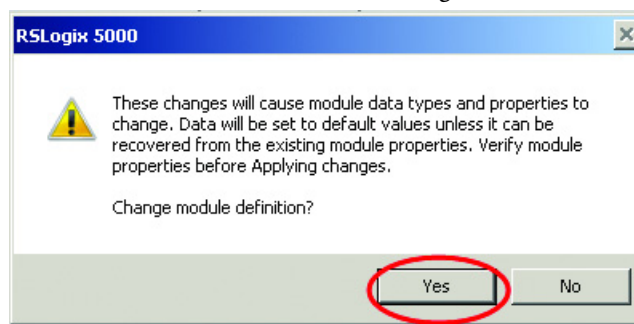

The module properties screen appears on the General Tab.

6. Click the IO-Link tab.

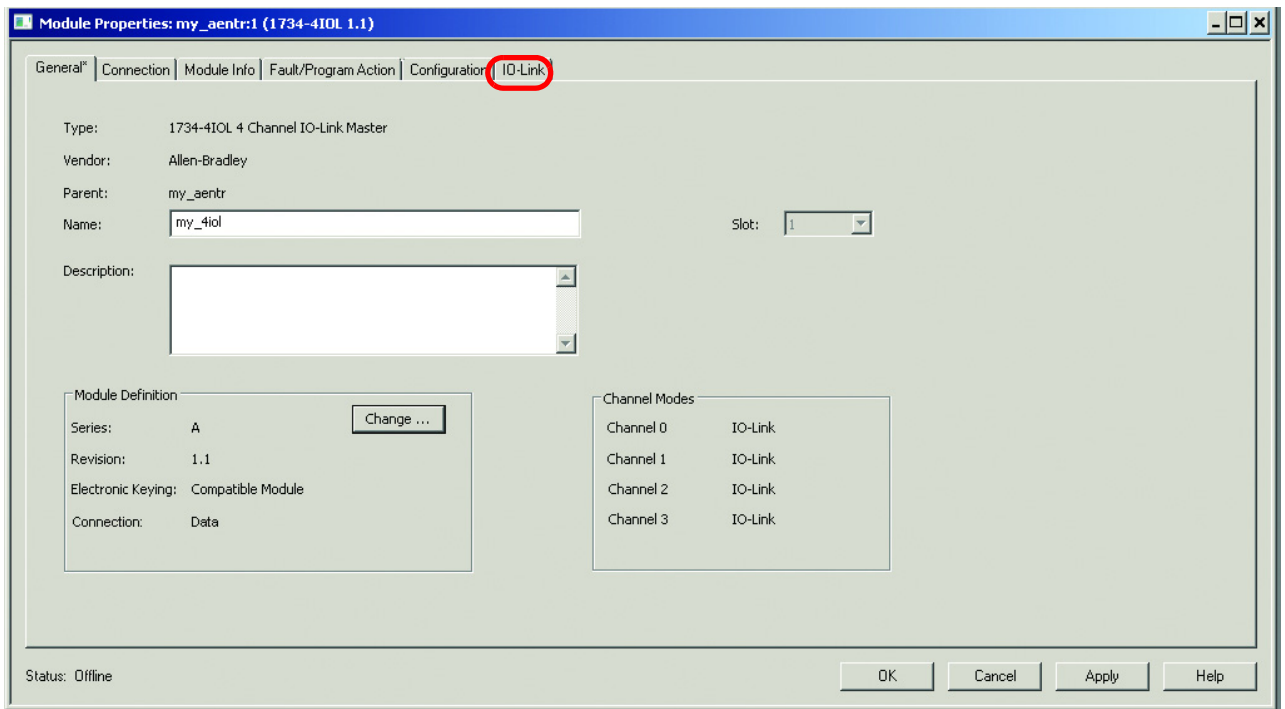

7. Locate the sensor that you added in the organization tree and select it.

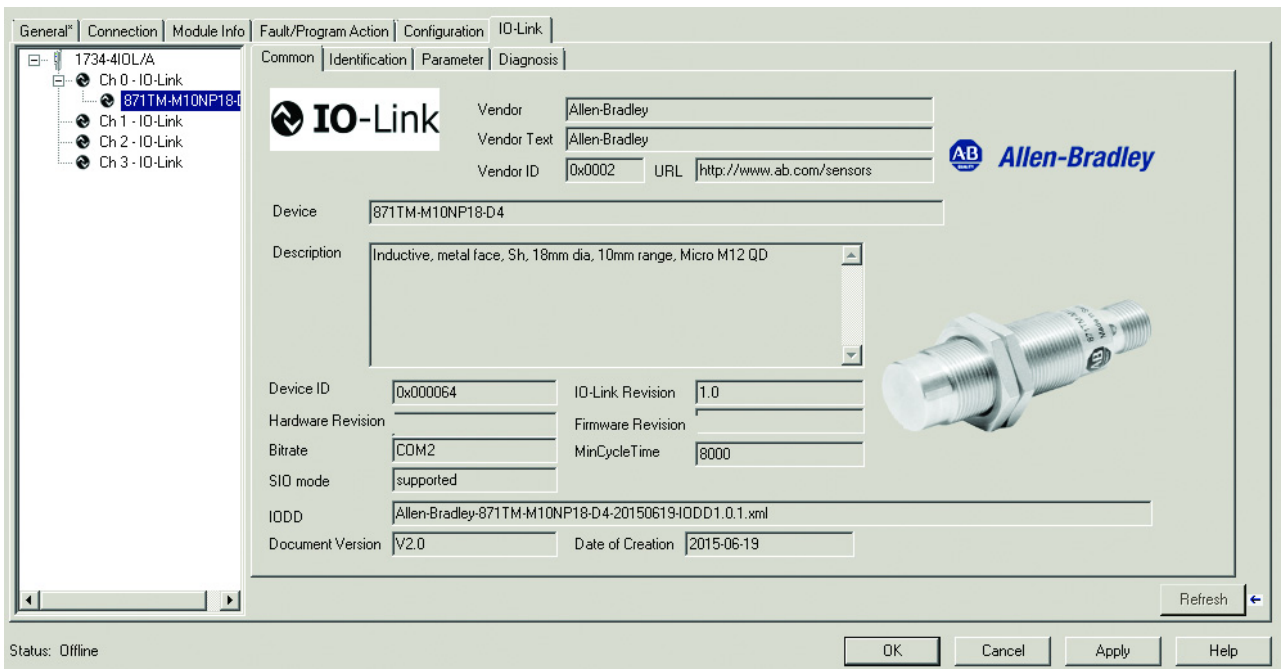

The sensor can now be configured through the AOP.

8. Click Go Online to communicate with the controller and sensor.

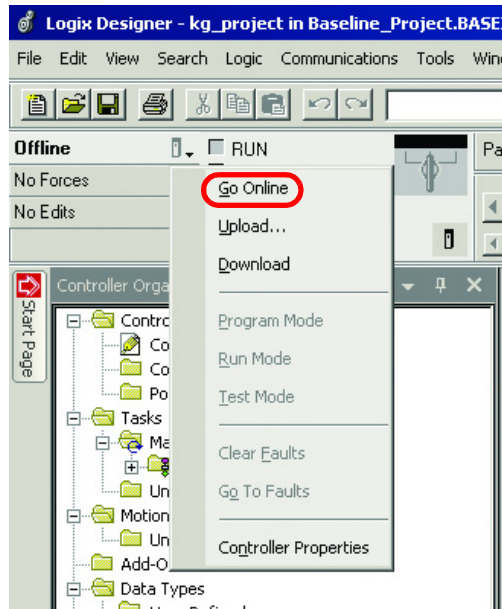

Proceed to [Chapter 9 on page 49](#) for a description of each tab that is associated with the 1734 AOP and a description of how the AOP can be used to configure the sensor.

**Notes:**



## Register the 871TM IODD

If you are not able to locate the 871TM in the IO-Link Sensor Library (as shown in the previous chapter), then you must register the IODD of the sensor. By default, the IODDs are already located in the Add-on Profile (AOP), but as new products are released it is necessary to add products to the library.

The I/O Device Description (IODD) files contain the information that is related to the sensor, integrated into the system environment. To initialize a sensor on an IO-Link Master, you must register the IODD of the sensor.

If the IODD file for the sensor cannot be located in the library, it can be downloaded from [rok.auto/pcdc](http://rok.auto/pcdc). Once the IODD is registered, there is no need to register the IODD again unless it is manually deleted from the Master Tree.

### Registration Procedure

1. Double-click 1734-4IOL in the Controller Organizer Tree.

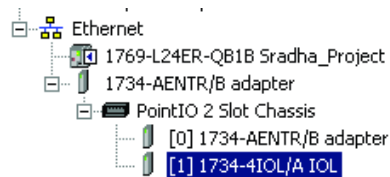

2. Click the IO-Link tab.

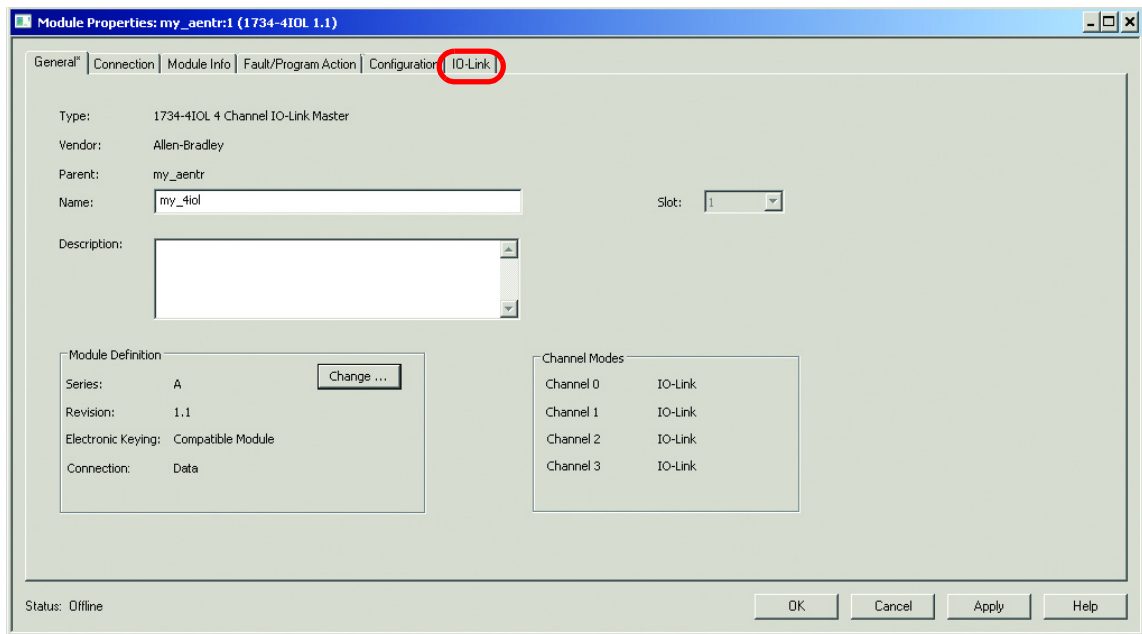

3. On the IO-Link screen, click Change.

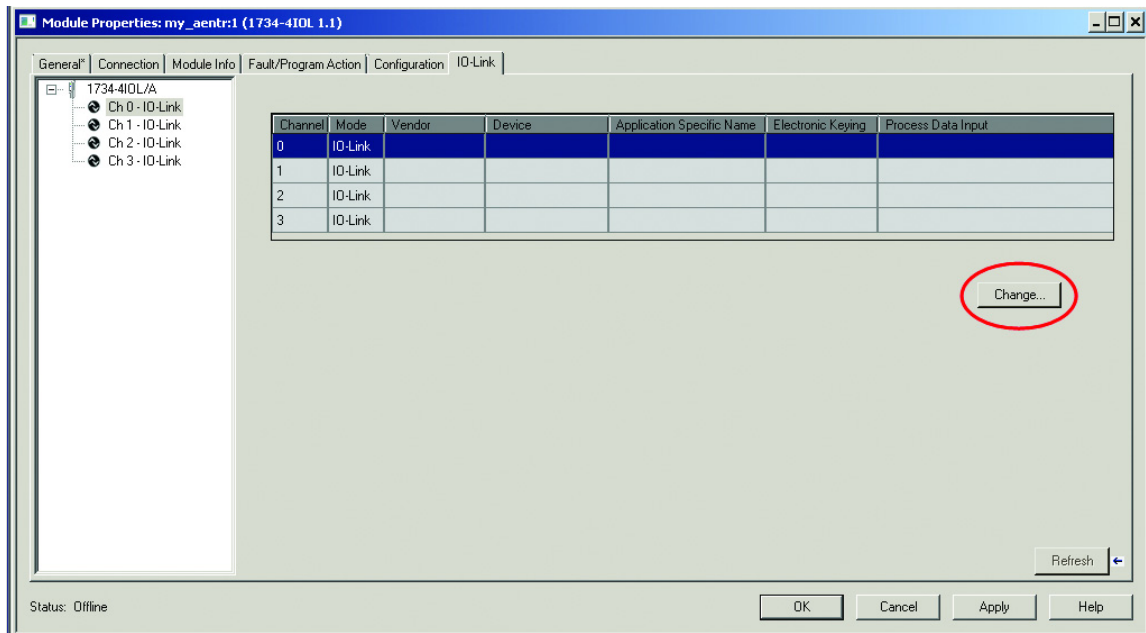

4. Click in the Change Device column for the IO-Link channel number that the sensor is added to.

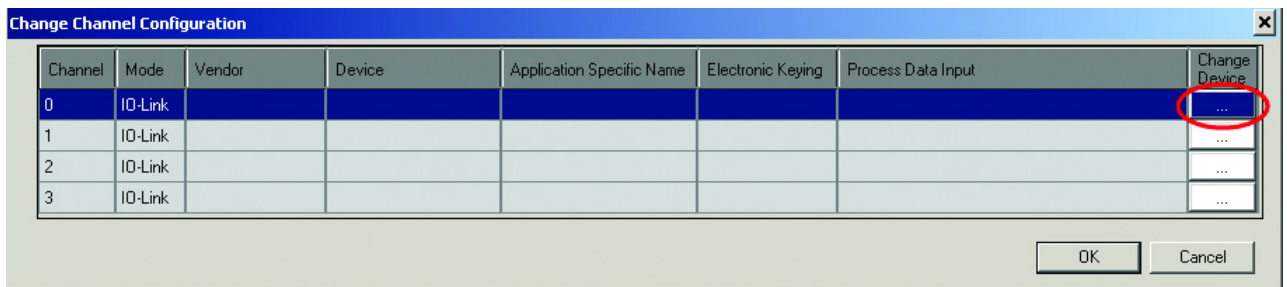

5. In the IO-Link Device Library window, click Register IODD.

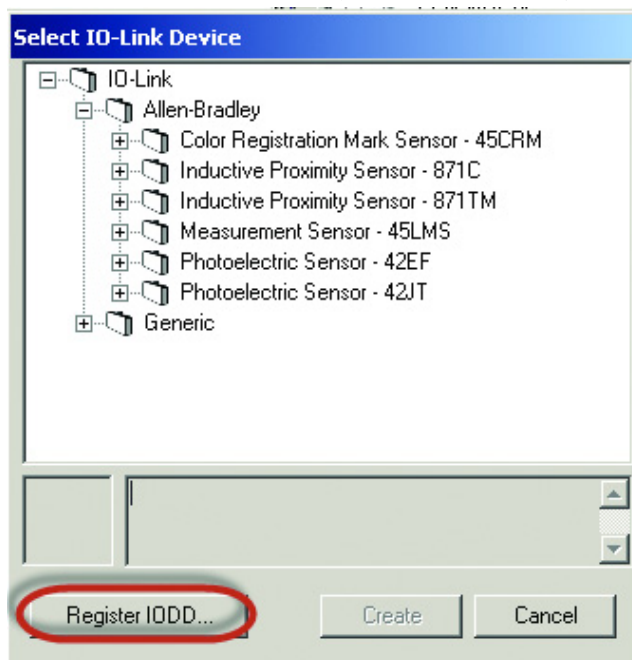

6. Click Register IODD in the following dialog box.

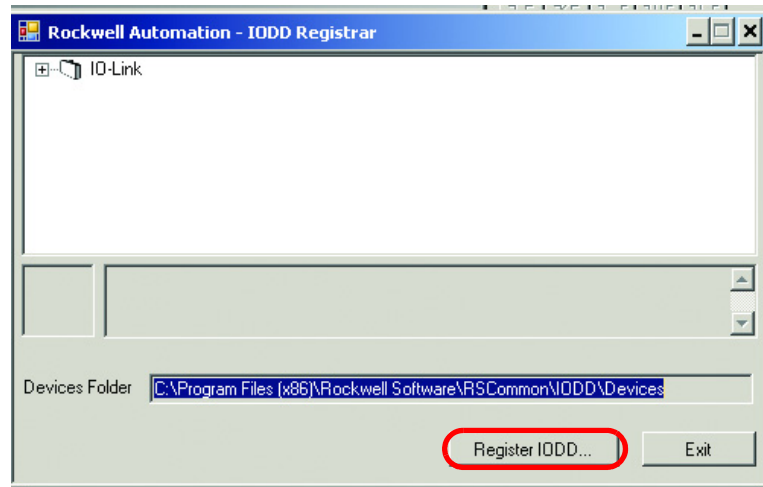

7. Locate the IODD XML file and double-click it. Then, click Open.

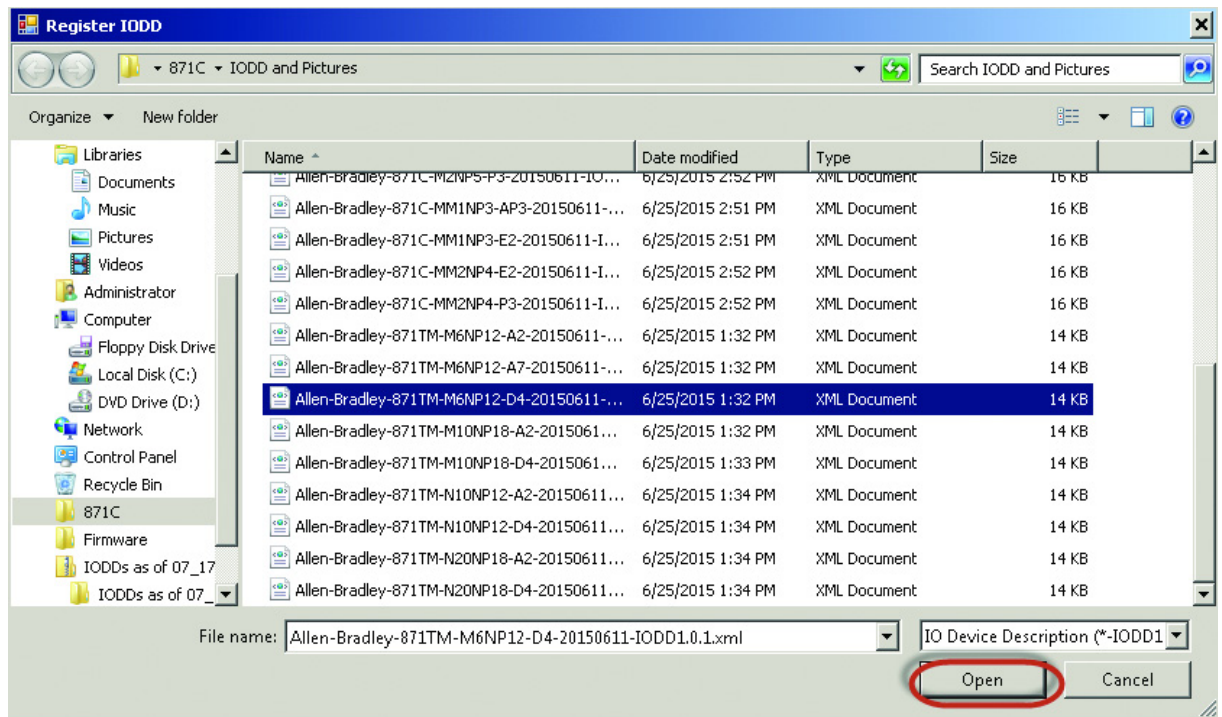

8. Click Exit.

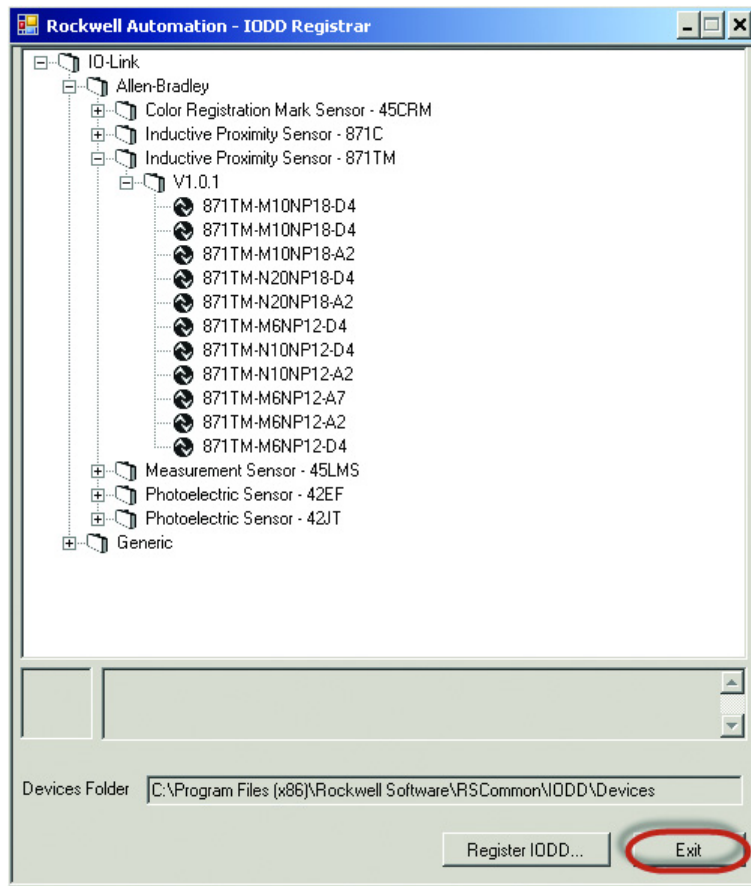

The 871TM is now visible in the IO-Link Device Library.

- Select the appropriate sensor and click Create.

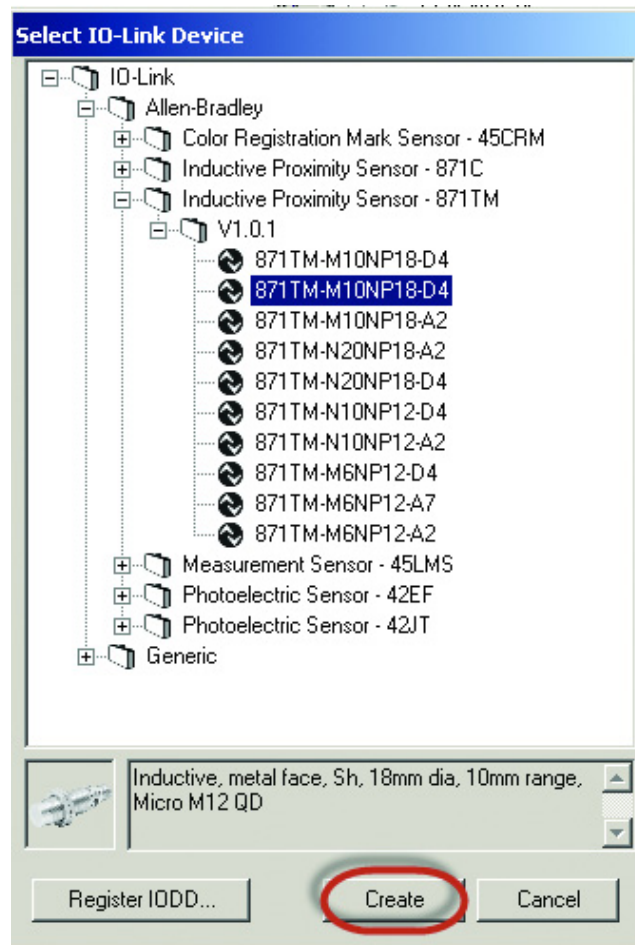

- Verify that the sensor appears in the channel configuration window and click OK.

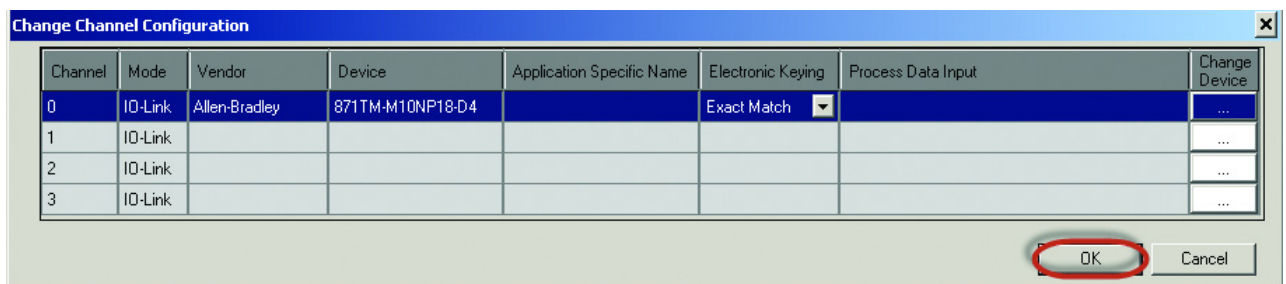

You can change the Application Specific Name, Electronic Keying, and Process Data Input configuration while the project is in the offline mode.

---

**IMPORTANT** The 871TM IO-Link does not support Application Specific Name or Process Data Input configuration.

---

Modify the information:

- Application Specific Name (ASN):** The purpose of the Application Specific Name is to add theme naming to distinguish the sensors within a machine and the associated project profile in the AOP. The ASN allows for easier maintenance and operation since the device is further identified by how it is used on the machine/project.

- **Electronic Keying Information:** Select Exact Match or Disabled from the pull-down menu. The Exact Match and Disabled keying options in this dialog correspond to the Compatible and No Check keying options in IO-Link terminology, respectively.

When Exact Match is selected, the connected IO-Link device must have the same Vendor ID, Device ID, and Revision information that has been configured for that channel. If they do not match, IO-Link communications is not established and a Keying Fault status bit is set. When Disabled is selected, key check is not performed.

- **Process Data Input:** Select the input data from the pull-down menu (for devices that support multiple layouts of input data).

Click OK.

11. Click Yes to confirm the sensor changes.

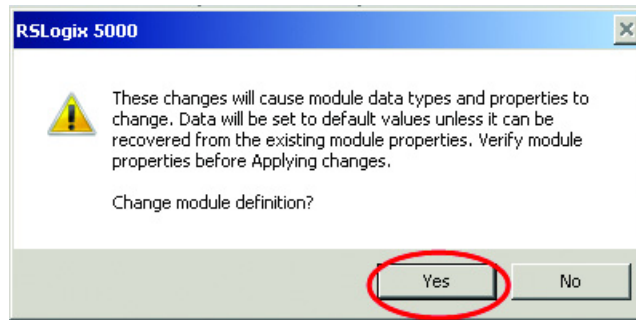

The module properties screen appears on the General Tab.

12. Click the IO-Link tab and navigate to the sensor that was added. The sensor can now be programmed through the AOP.

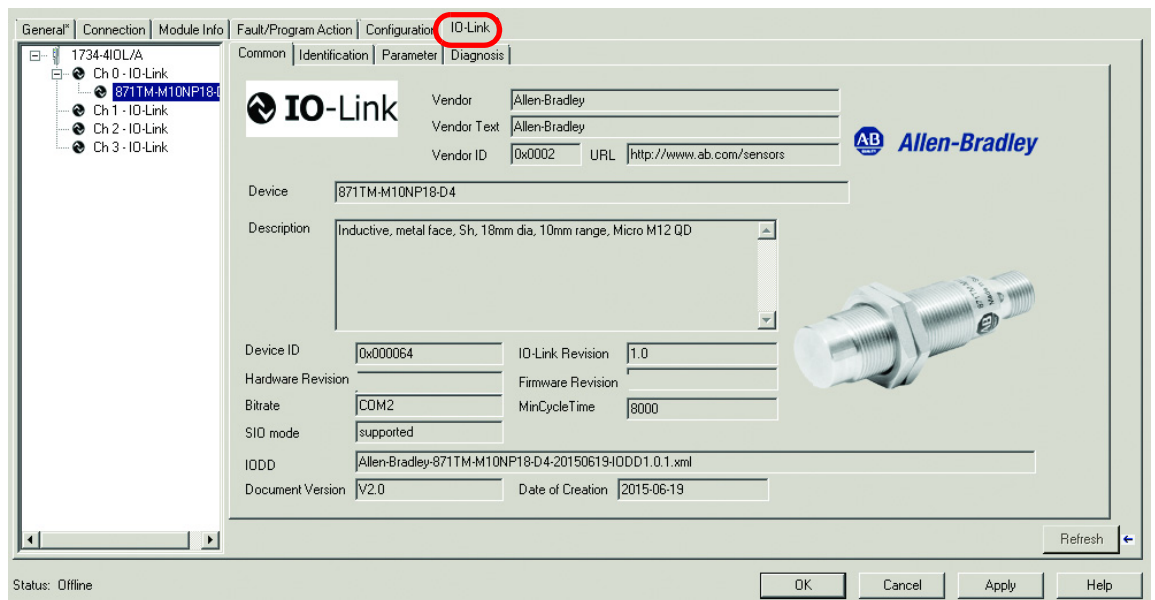

13. Click Go Online to communicate with the controller and sensor.

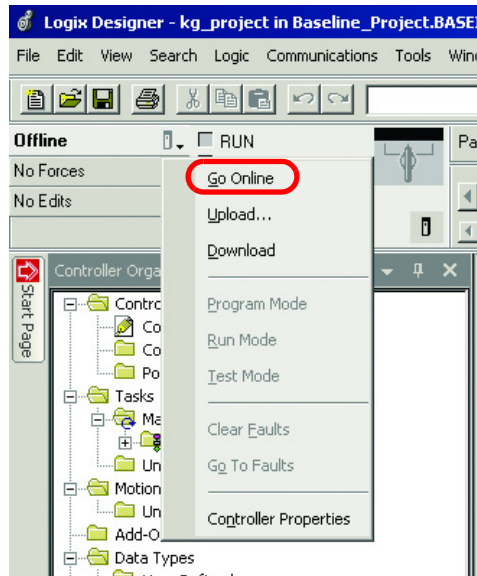

The IODD registration and connection to the IO-Link master is complete.

Proceed to [Chapter 9 on page 49](#) for a description of each tab that is associated with the 1734 AOP and a description of how the AOP is used to configure the sensor.

**Notes:**



## Review the 1734-4IOL IO-Link Add-on Profile

### Overview

#### Device Parameter Behavior

IO-Link parameters are shown in the Add-on Profile (AOP) only for IO-Link devices with IODD Advanced integration. Each parameter can have an attribute of read-only (ro), read-write (rw), or write only (wo). The behavior of parameters and the source for their values differ whether you are offline or online.

**Table 5 - IO-Link Device Parameter Behavior**

Attribute	Offline	Online
Read-only (ro)	Parameters are blank.	Parameter values are read from the connected IO-Link device. Parameters show "??" when communication breaks.
Read-write (rw)	Parameter values are read from the IODD file when the IO-Link device is added. Changes made to the parameters are applied when the OK and Apply buttons are clicked.	Parameter values can be edited and changes made to the parameters are applied when the OK and Apply buttons are clicked. Changes are sent to the Master Module, which then writes the changes to the connected IO-Link device.
Write only (wo)	Parameter buttons are disabled.	Parameter buttons that could potentially alter the Process Data are disabled. Other parameter buttons that are enabled, result in commands being sent to the connected IO-Link device.

The 1734-4IOL AOP offers four different tabs to describe the sensor functionality and operation. These tabs are:

- **Common Tab:** General product information about the sensor specifications and IO-link IODD information.
- **Identification Tab:** Sensor cat. no., series letter, general product description including the current product firmware, and hardware revisions.
- **Parameter Tab:** Different configurable parameters available in the 871TM.
- **Diagnosis Tab:** Monitor IO-Link communication characteristics.

For a complete listing of all sensor parameters and parameter definitions, see [Device Parameters on page 77](#).

## Common Tab

The common tab is automatically generated to give general information about the sensor. The tab contains:

- Vendor
- Vendor ID
- URL
- Device and Description
- Device ID
- IO-Link Revision
- Hardware and Firmware Revision
- Bitrate
- MinCycle Time
- IODD
- Document Version
- Date of creation



## Identification Tab

The Identification tab shows device information such as specific Vendor ID and Device ID for the exact sensor that is configured. These fields are automatically populated according to the sensor information. These fields are Read Only (ro).

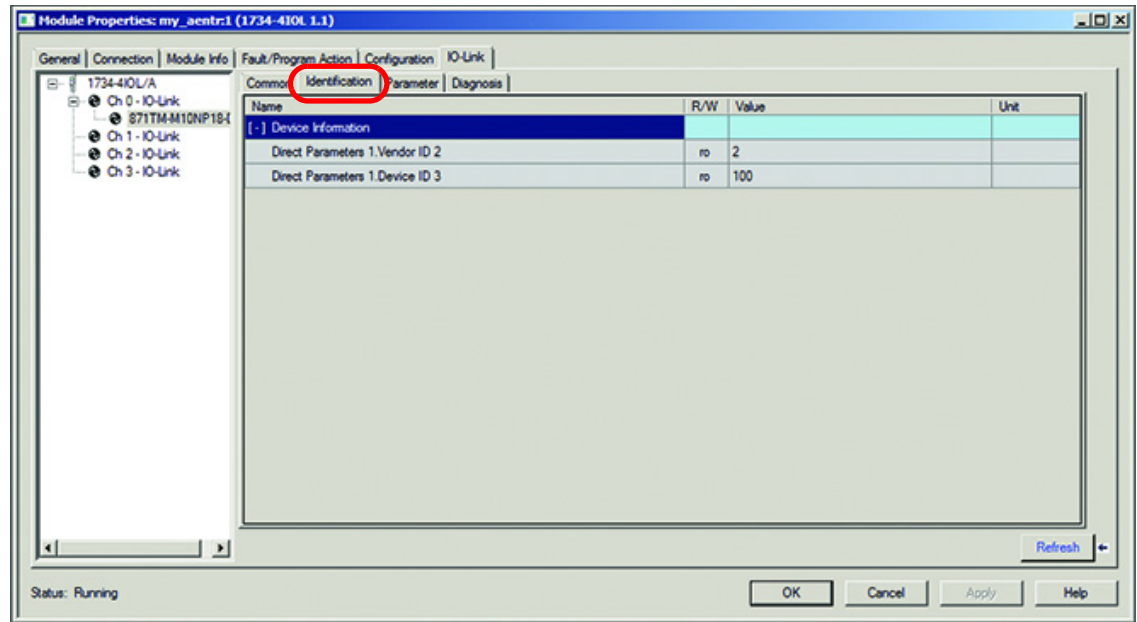

## Parameter Tab

The Parameter tab allows changes to the behavior of the output of the sensor. The IO-Link master uses these parameters for validation purposes.

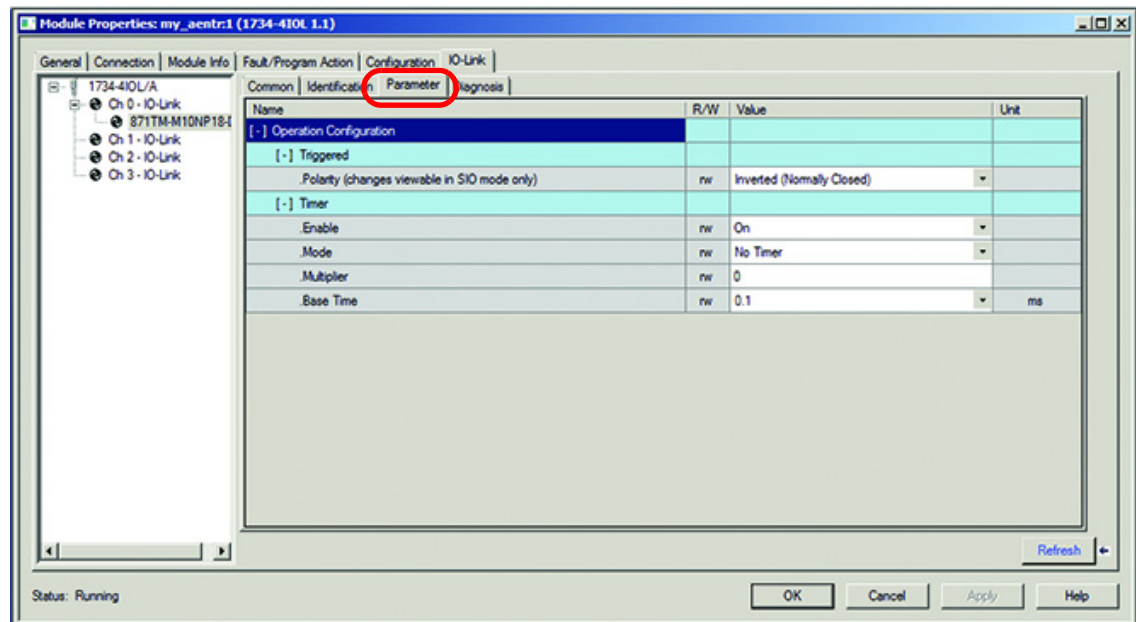

## Polarity

The 871TM sensor features the ability to change the output switching mode. The factory default mode is Not Inverted (normally open). With the sensor in IO-Link mode, you can change the polarity parameter to Inverted (normally closed). The sensor cannot operate in Inverted (normally closed) mode while operating in IO-Link mode. Therefore, to use the Inverted (normally closed) functionality, the sensor must be disconnected from IO-Link and used as a standard input/output (SIO) device.

If you want to change the sensor back to “Not Inverted” (normally open), you must connect the sensor back to the IO-Link master and change the setting under the polarity parameter.

## Switching Timer Mode

The switching timer is a useful function for manipulating the output of the sensor in relation to timing. It is useful for precision applications where the output of the sensor must be precisely triggered at a certain time. It is important to note that the lowest time base must be used and that there is a tolerance error of approximately ±15%.

---

**IMPORTANT** The enable parameter must be ON to enable the switching timer mode.

---

The 871TM sensor uses a time base with an associated offset value along with a multiplier to create a delay value when using the switching timer mode function. It is important that the smallest time base and multiplier is used to create the delay. By using the smallest time base and multiplier, the tolerance error of ±15% can be reduced. An example is provided to understand the relationship between the different input values. The maximum delay that can be entered is 537.6 ms.

$$\text{Desired Time Delay} = (\text{Time Multiplier})(\text{Time Base}) + \text{Offset Value}$$

Time Base	Offset Value (ms)	Timer Multiplier (ms)
0 = 0.1 ms	0	0...63 ms
1 = 0.4 ms	6.4	
2 = 1.6 ms	32	
3 = 6.4 ms	134.4	

*For example: To achieve a delay of approximately 24 milliseconds, you must use a time base of 1 (0.4 ms) and 44 milliseconds for a timer base multiplier. This value does not factor in the tolerance error of ±15%.*

$$24 \text{ ms} = (44) (0.4) + 6.4 \text{ ms}$$

**No Timer** = sensor performs without any delays with the output before or after the target is presented in front of the sensor

**Off Delay** = sensor triggered bit stays ON after the target is removed from the face of the sensor. The time the output is triggered ON after the target is removed as dictated by the time base set and the multiplier used.

For example: Using the example above, implement an off delay of 24 ms.

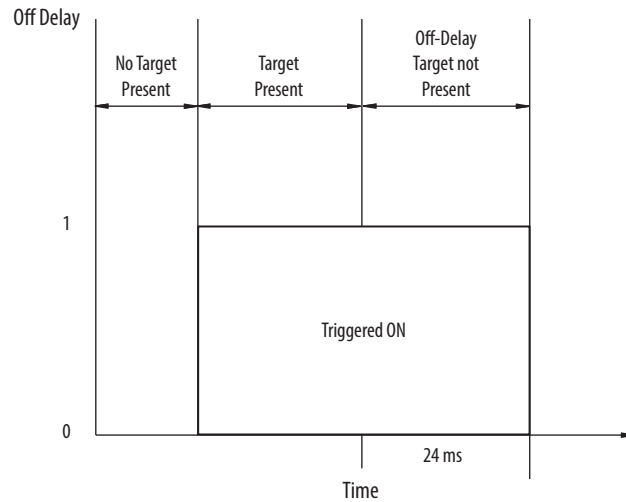

**On Delay** = target is presented in front of the sensor, sensor triggered bit stays OFF until switching time base and the multiplier time period have elapsed. Once that time frame has elapsed, the trigger bit turns ON.

For example: Using the example above, implement an On Delay of 24 ms.

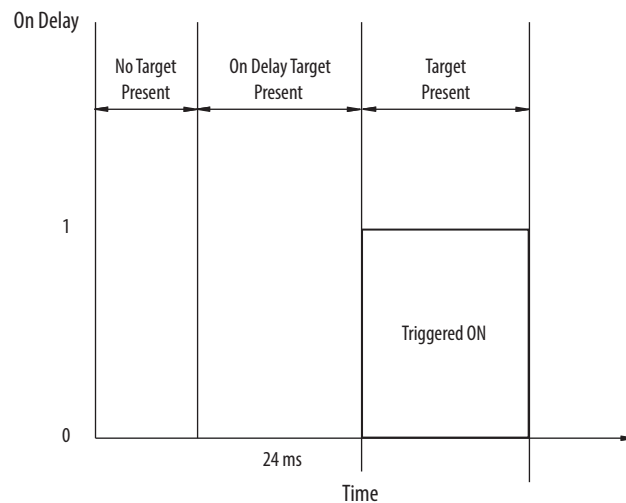

**On Delay and Off Delay** = Target is presented in front of the sensor, sensor triggered bit stays OFF until switching time base and the multiplier have elapsed. Once that time frame has elapsed, the trigger bit turns ON as long as target is present. The sensor triggered bit stays ON after the target is removed from the face of the sensor. The time the output is triggered ON after the target is removed as dictated by the time base set and the multiplier used.

For example: Using the example above, implement an On Delay and Off Delay of 24 ms.

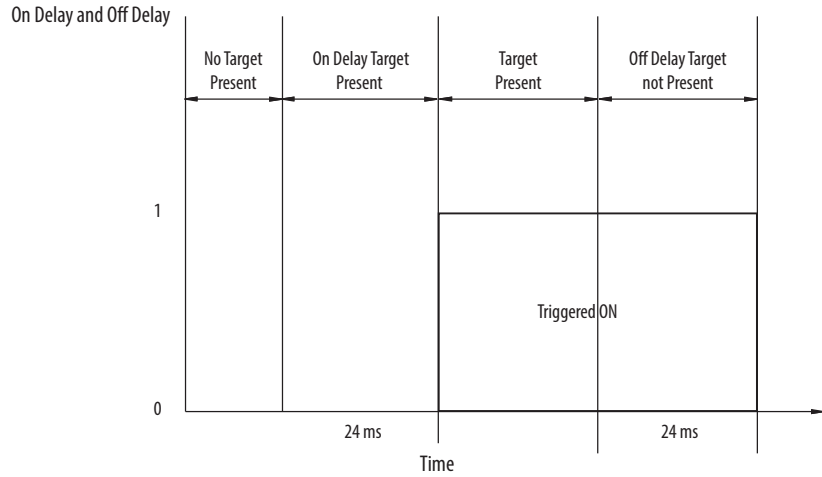

## Diagnosis Tab

The Diagnosis tab shows the user communication characteristics such as cycle time and IO-Link Revision ID.

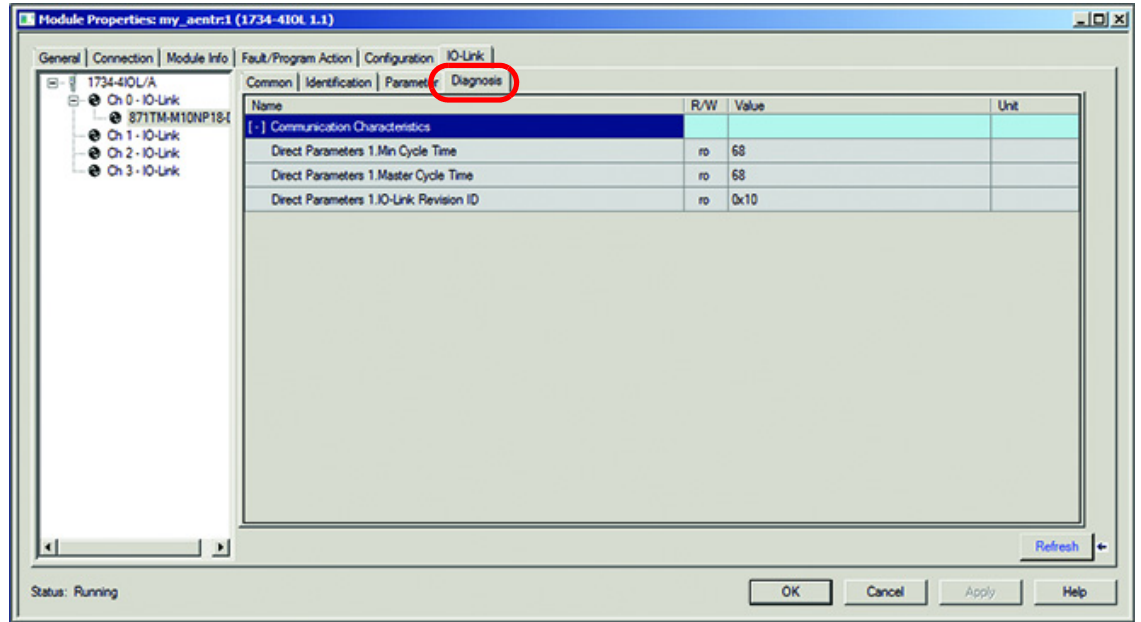

# Controller Tags

The controller tags have two process data tags that show the status of the sensor concerning the output and the margin status.

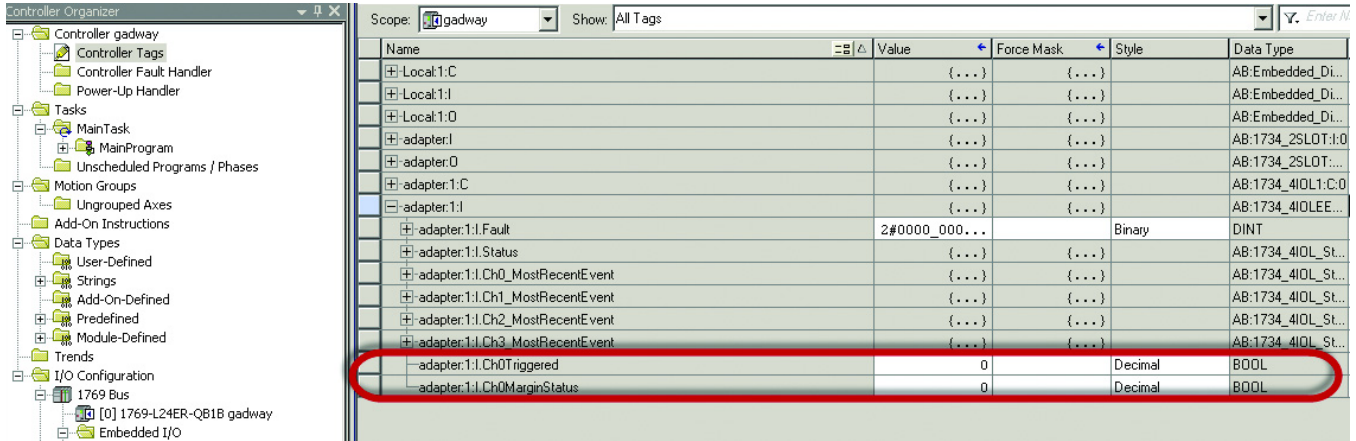

**Triggered:** This process bit turns toggles to (1) when the sensor detects the target and to (0) when the sensor does not detect the target. The sensor operates as normally open when connected to IO-Link regardless of whether it is normally closed.

**Margin Status:** The bit can be used as a low margin warning indicator to detect the target is beyond the recommended working range of the sensor. This process bit toggles to High (1) when the sensor detects a target AND the target is between 0...80% of the operating range of the sensor. The process bit toggles to Low (0) when the sensor detects a target beyond 80% of the specified operating range of the sensor.

The recommended working range of the sensor is less than 80% of the specified or nominal sensing range. Operation within the working range of the sensor helps sustain stable operation with typical environmental temperature, load, and supply voltage fluctuations and differences due to the manufacturer tolerances.

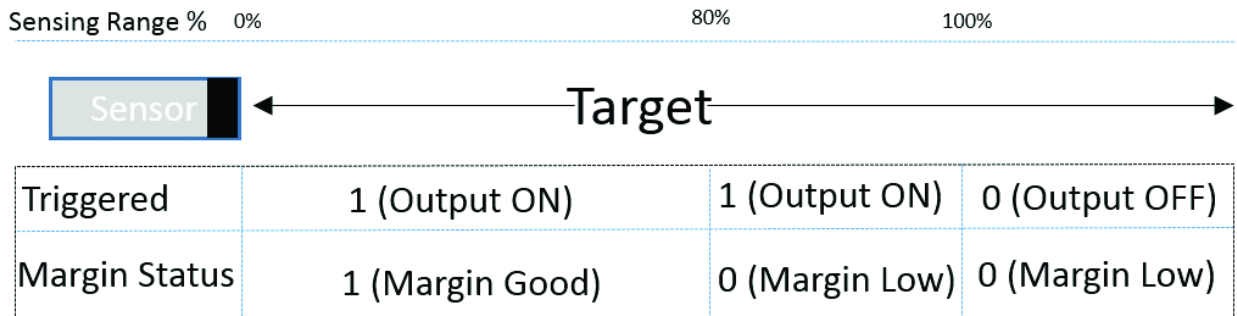

**Notes:**



## Configure the Sensor with the Studio 5000 Environment

This chapter provides detailed instructions on the configuration of the 871TM sensor using message instructions in the Studio 5000® environment. The example code that is shown allows you to:

- Read the sensor configuration
- Set the time delay multiplier

### Sample Code

To download the sample code that is shown in this chapter, find the IO-Link 871TM Explicit Messaging Example from the Sample Code Library ([rockwellautomation.com/en-us/support/product/product-downloads/application-code-library/sample-code.html](http://rockwellautomation.com/en-us/support/product/product-downloads/application-code-library/sample-code.html)) and follow these steps:

1. Save and Extract PROX\_871\_TM.L5X to a folder of your choice.
2. Within your Logix Studio program, right-click Main program and click Import Routine.

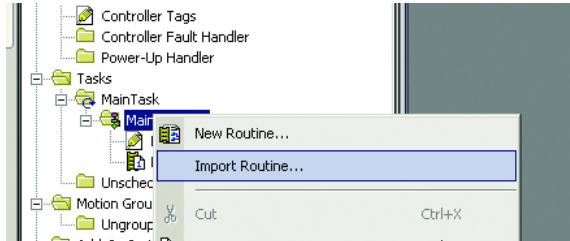

3. Browse to the folder that contains the routine that is extracted in [step 1](#). Select and click Import.

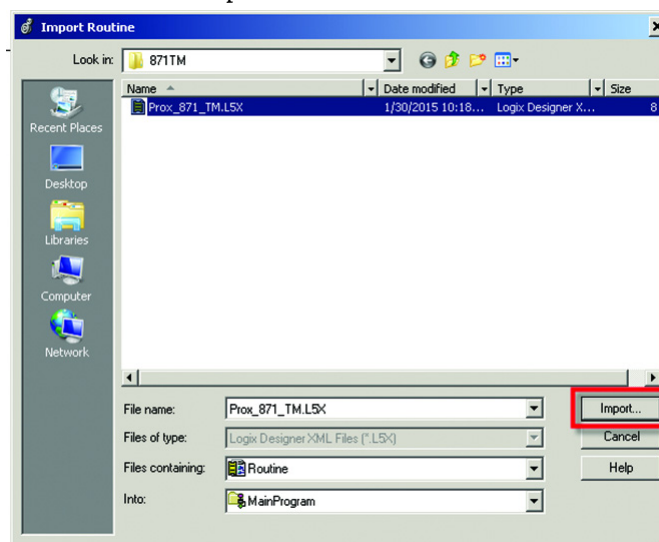

- In Import Configuration window, click OK to accept the default settings.

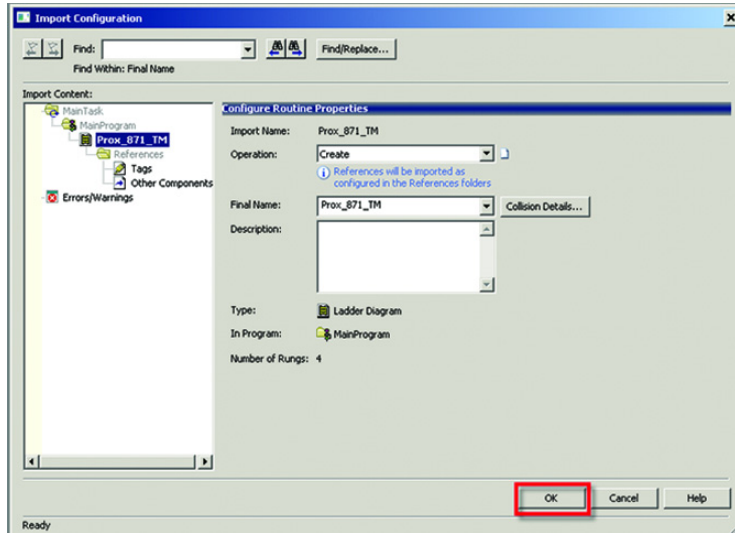

- From within the MainRoutine, create a rung of code that runs the subroutine PROX\_871\_TM.



- Open the 871\_TM subroutine. On rung 0 within the MSG instruction, click the square button to open the message configuration.

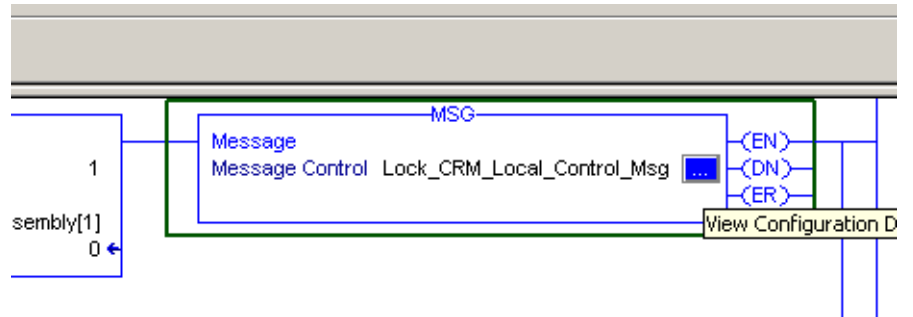

7. In the Message configuration window, click the Communication Tab and then click Browse.

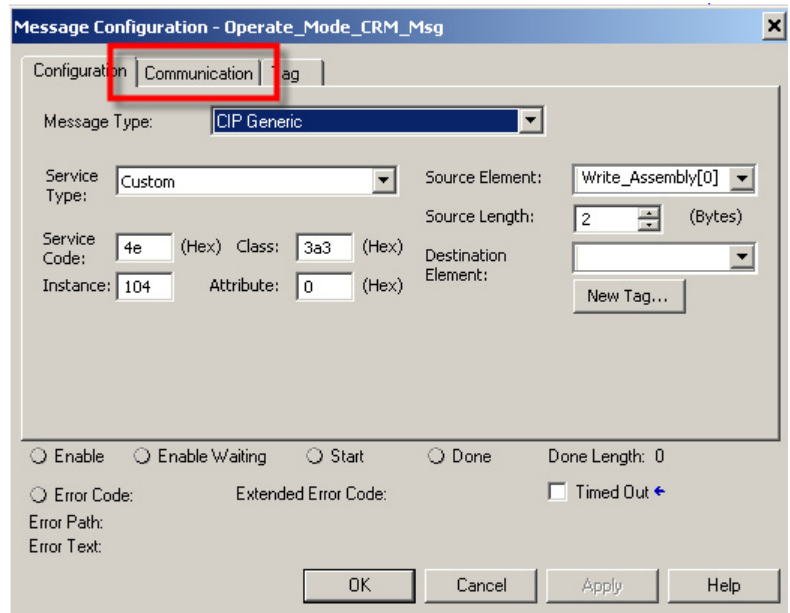

8. Browse the Ethernet network to the 1734-AENTR/B adapter and select the 1734-4IOL Master. Click OK.

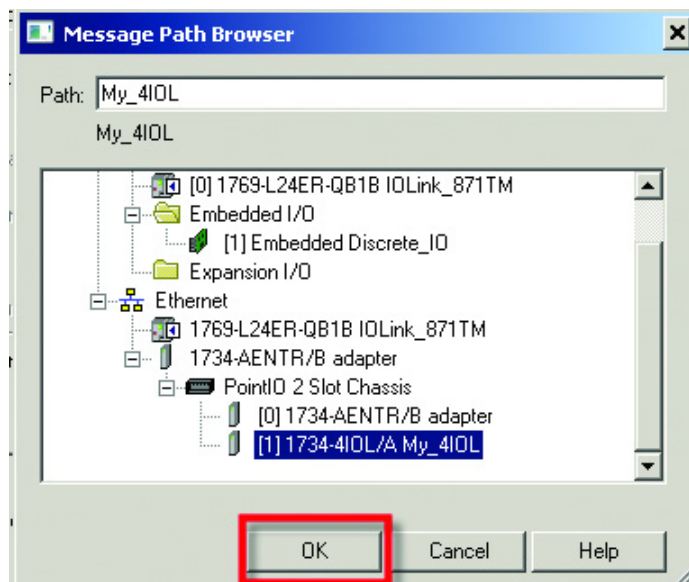

Notice that the path is now set to My\_4IOL in the communication path. Click Apply and then click OK.

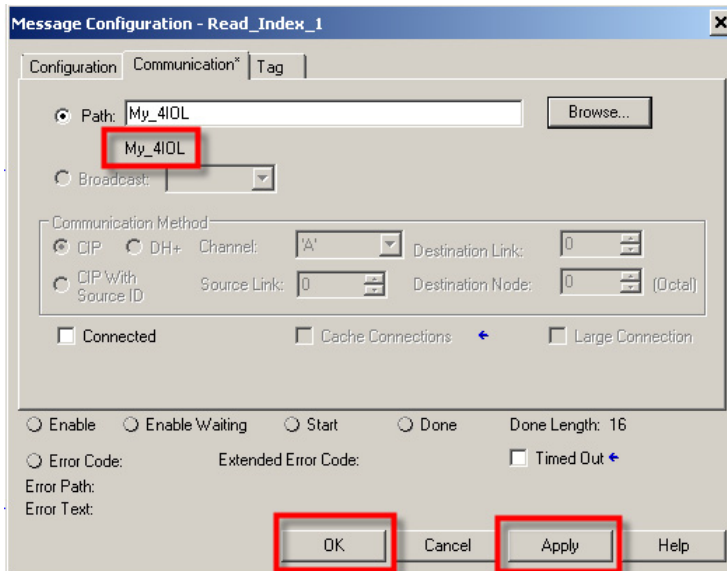

9. Repeat [step 8](#) for the Message instructions on rung 12 (Write\_Index\_1).
10. Verify that the routine is free of Errors.

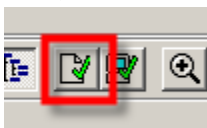

11. Press Download to download the Program to the controller.

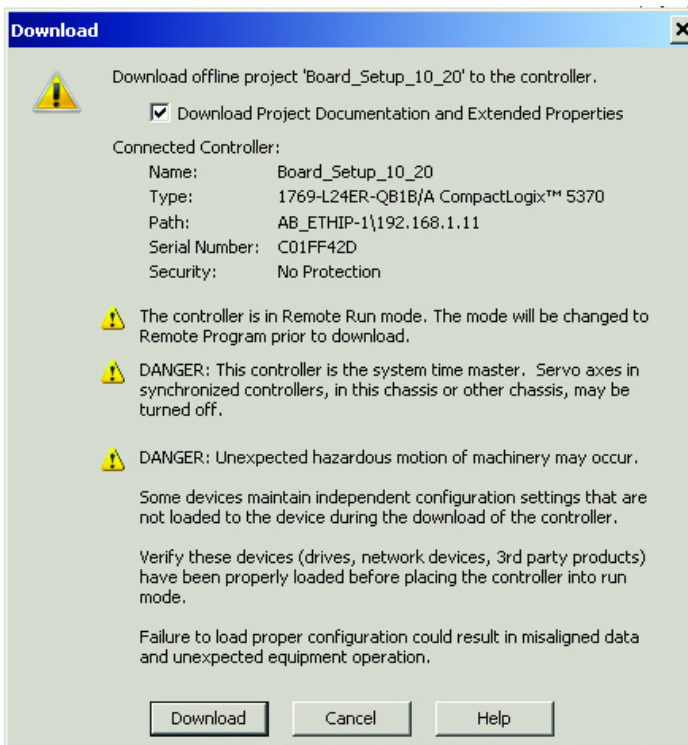

12. Click Yes to put the Controller back to Run mode.

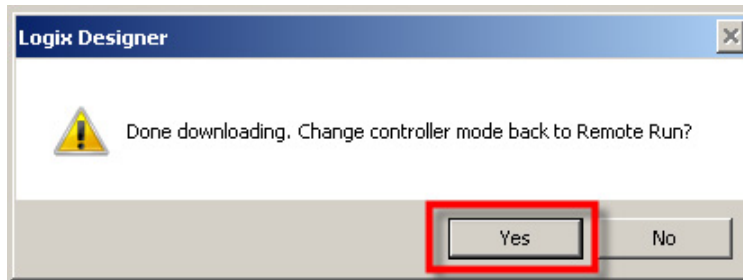

## Operation

The 871™ sensor conforms to V1.0 of the IO-Link standard. The parameters of the sensor are defined in Index 1. Index 1 consists of 128 bits of data. Data starts at an offset of 80 bits. When using explicit messages to read and change the sensor, configuration of the whole index must be read/written to.

Open the Controller Tag viewer and locate the tag that is named Sensor\_Channel. Set this tag to equal the channel number the 871™ sensor is connected to on the 1734-4IOL module.

## Read the 871™ Configuration Via Explicit Message

Toggle the Read\_Index contact on rung 1. This action runs the Message instruction to read the data that is contained in Index 1.



Select the contact and press Ctrl-T to toggle contacts.

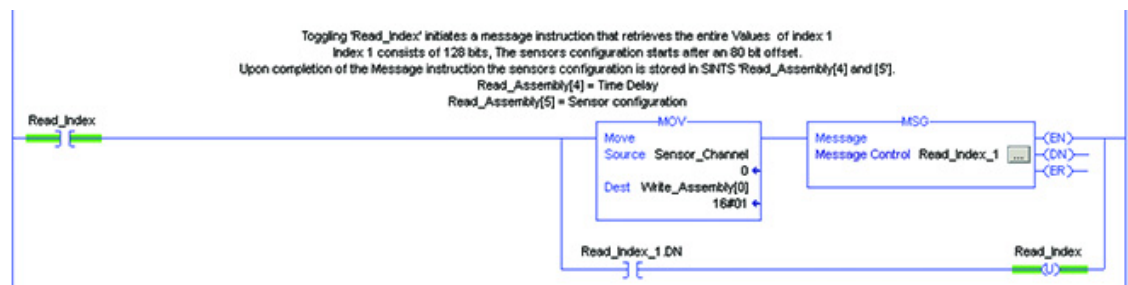

The sensor configuration is read back into the Read\_Assembly array. Open the controller tags from within the controller organizer. Expand the Read\_Assembly array. The configuration is detailed in Read\_Assembly[4] and [5].

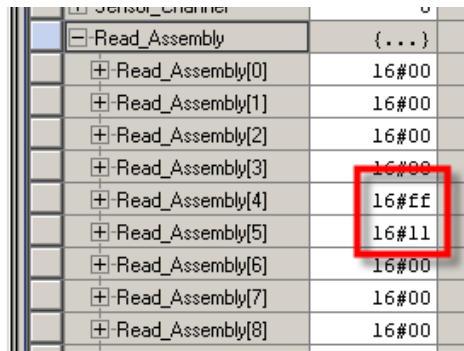

### Decipher the Data

Read\_Assembly[4] Contains the Hex equivalent of the time delay in milliseconds. Use [Table 6](#) to convert the value to milliseconds.

Table 6 - Hex Value Conversion

Delay Value (ms)	Hex Value	Delay Value (ms)	Hex Value	Delay Value (ms)	Hex Value	Delay Value (ms)	Hex Value	Delay Value (ms)	Hex Value	Delay Value (ms)	Hex Value	Delay Value (ms)	Hex Value	Delay Value (ms)	Hex Value
0	0	2.6	1A	5.2	4D	12	5E	22.4	8E	54.4	A2	96	CF	243.2	E6
0.1	01	2.7	1B	5.3	35	12.4	5F	22.8	79	56	A3	97.6	BD	249.6	E7
0.2	02	2.8	47	5.4	36	12.8	C2	23.2	7A	57.6	C9	99.2	BE	256	E8
0.3	03	2.9	1D	5.5	37	13.2	61	23.6	7B	59.2	A5	100.8	BF	262.4	E9
0.4	41	3	1E	5.6	4E	13.6	62	24	8F	60.8	A6	102.4	D0	268.8	EA
0.5	05	3.1	1F	5.7	39	14	63	24.4	7D	62.4	A7	108.8	D1	275.2	EB
0.6	06	3.2	82	5.8	3A	14.4	89	24.8	7E	64	CA	115.2	D2	281.6	EC
0.7	07	3.3	21	5.9	3B	14.8	65	25.2	7F	65.6	A9	121.6	D3	288	ED
0.8	42	3.4	22	6	4F	15.2	66	25.6	C4	67.2	AA	128	D4	294.4	EE
0.9	09	3.5	23	6.1	3D	15.6	67	27.2	91	68.8	AB	134.4	D5	300.8	EF
1	0A	3.6	49	6.2	3E	16	8A	28.8	92	70.4	CB	140.8	D6	307.2	FO
1.1	0B	3.7	25	6.3	3F	16.4	69	30.4	93	72	AD	147.2	D7	313.6	F1
1.2	43	3.8	26	6.4	C1	16.8	6A	32	C5	73.6	AE	153.6	D8	320	F2
1.3	0D	3.9	27	6.8	51	17.2	6B	33.6	95	75.2	AF	160	D9	326.4	F3
1.4	0E	4	4A	7.2	52	17.6	8B	35.2	96	76.8	CC	166.4	DA	332.8	F4
1.5	0F	4.1	29	7.6	53	18	6D	36.8	97	78.4	B1	172.8	DB	339.2	F5
1.6	81	4.2	2A	8	85	18.4	6E	38.4	C6	80	B2	179.2	DC	345.6	F6
1.7	11	4.3	2B	8.4	55	18.8	6F	40	99	81.6	B3	185.6	DD	352	F7
1.8	12	4.4	4B	8.8	56	19.2	C3	41.6	9A	83.2	CD	192	DE	358.4	F8
1.9	13	4.5	2D	9.2	57	19.6	71	43.2	9B	84.8	B5	198.4	DF	364.8	F9
2	45	4.6	2E	9.6	86	20	72	44.8	C7	86.4	B6	204.8	E0	371.2	FA
2.1	15	4.7	2F	10	59	20.4	73	46.4	9D	88	B7	211.2	E1	377.6	FB
2.2	16	4.8	83	10.4	5A	20.8	8D	48	9E	89.6	CE	217.6	E2	384	FC
2.3	17	4.9	31	10.8	5B	21.2	75	49.6	9F	91.2	B9	224	E3	390.4	FD
2.4	46	5	32	11.2	87	21.6	76	51.2	C8	92.8	BA	230.4	E4	396.8	FE
2.5	19	5.1	33	11.6	5D	22	77	52.8	A1	94.4	BB	236.8	E5	403.2	FF

Read\_Assembly[5] contains the Hex equivalent of the sensors configuration. The individual bits within this byte define the configuration of the timer being enabled, Sensor Output, and On/Off Delay.

Normally Closed	Normally Open	Timer Disabled	Timer Enabled	Mode: On Delay Off Delay	Mode: On Delay	Mode: Off Delay	Mode: No Timer	Hex Value
	✓		✓				✓	00
	✓		✓			✓		01
	✓		✓		✓			02
	✓		✓	✓				03
	✓	✓					✓	04
	✓	✓				✓		05
	✓	✓			✓			06
	✓	✓		✓				07
✓			✓				✓	10
✓			✓			✓		11
✓			✓		✓			12
✓			✓	✓				13
✓		✓					✓	14
✓		✓				✓		15
✓		✓			✓			16
✓		✓		✓				17

### Write a New Configuration to the 871TM Via Explicit Message

1. The sensors configuration (NO/NC and Delay type) can be set by toggling the required contacts on rungs two through nine.
2. If you use a time delay, use [Table 6 on page 62](#) to determine the required time delay Hex value.

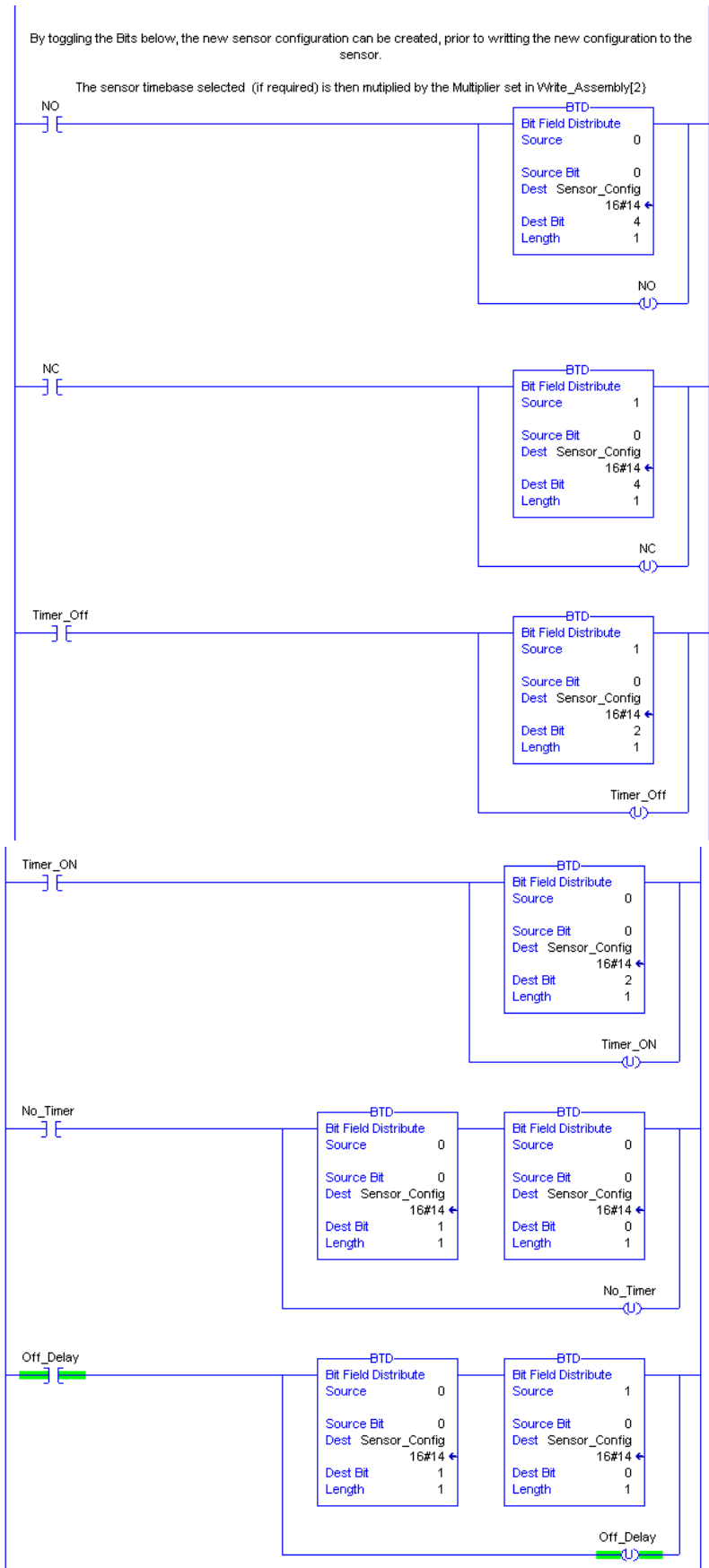



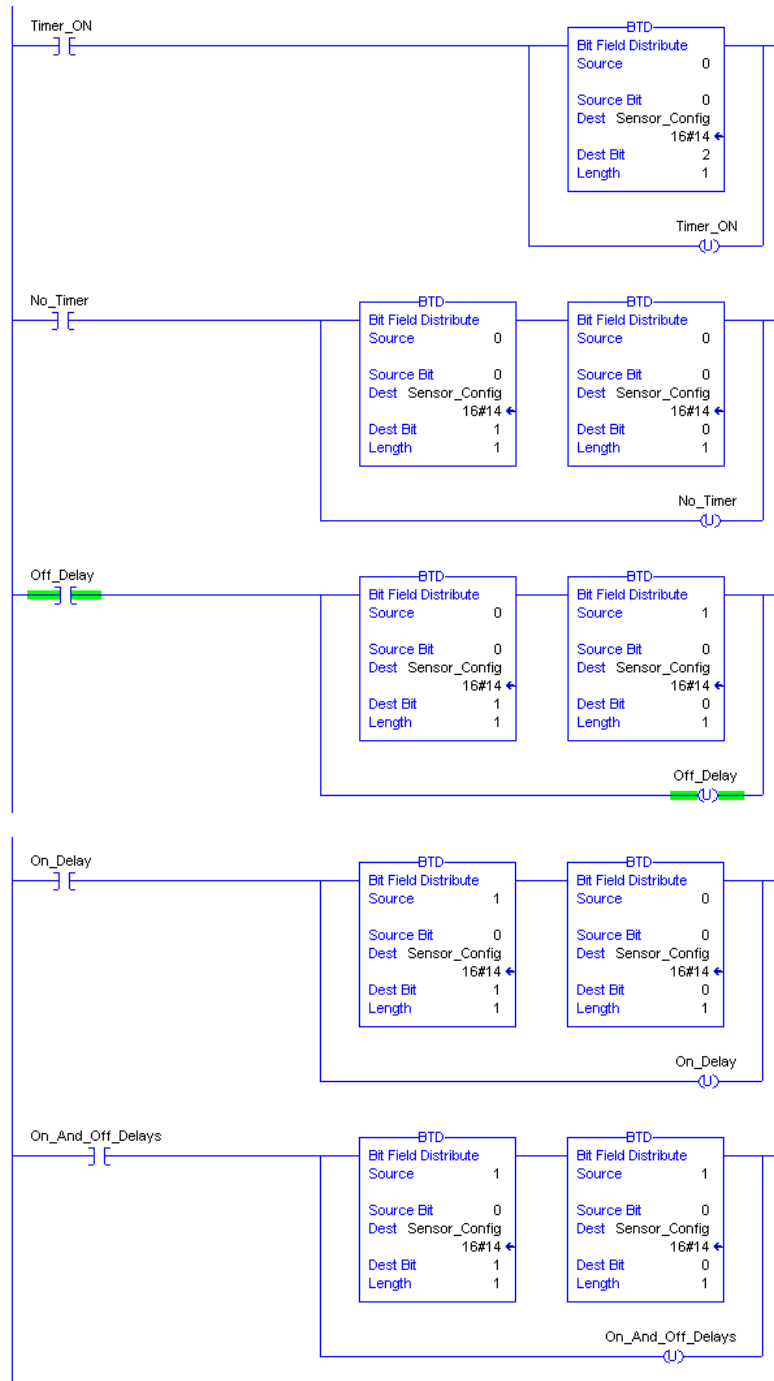

3. Within the Logic on rung three, double-click the numerical field below 'Time\_Delay\_ms' and enter the new hex value for the time delay. Then, press Enter.



Leave the 16# ahead of your entry.

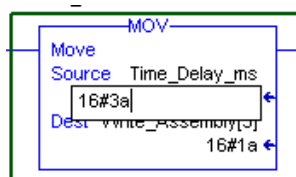

- Toggle the 'Write\_Index' contact to write new configuration to the 871TM.

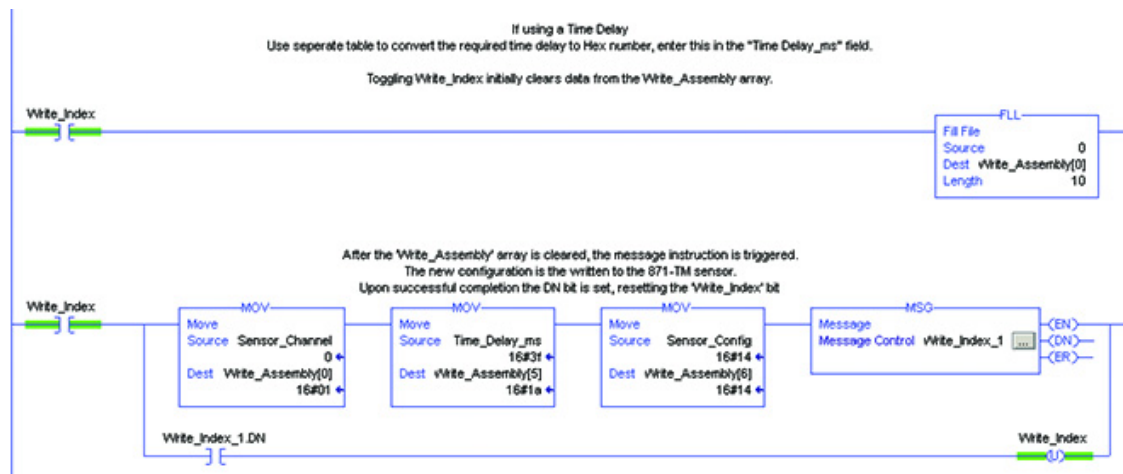

**IMPORTANT** The whole index has to be written to the sensor, it is required that both bytes be populated. If only one of the values must be changed, enter the value that you initially read into the other field.

- After writing to the index, perform a read index and validate that the sensor settings have been changed from the Controller Tag viewer. Additionally, open up the Master by clicking the 1734-4IOL Master in the I/O Configuration. RS Studio detects there is a difference between the actual configuration of the sensor and the configuration in the project. A popup box is displayed. Expand the '+' sign and the differences are shown.

**1734-4IOL/A - Differences Detected**

Resolve the differences by uploading the differences to the project or downloading them to each device.

Channel	Parameter	Project Value	Device Value	Upload	Download
[ - ] 0				<input type="checkbox"/>	<input type="checkbox"/>
	.Multiplier	0	63		
	.Polarity	Inverted (Norm...	Not Inverted (N...		
	.Mode	No Timer	Off Delay		

Upload/Download the Parameter Values

### Reset the Sensor to Default

1. Toggle the 'Default\_Sensor\_Config' contact. Default settings are normally open, no timer, off delay, and no multiplier

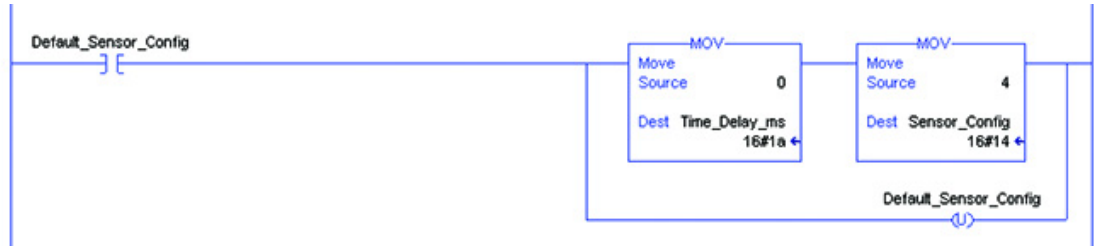

2. Then toggle the 'Write\_Index' contact on rung 11.

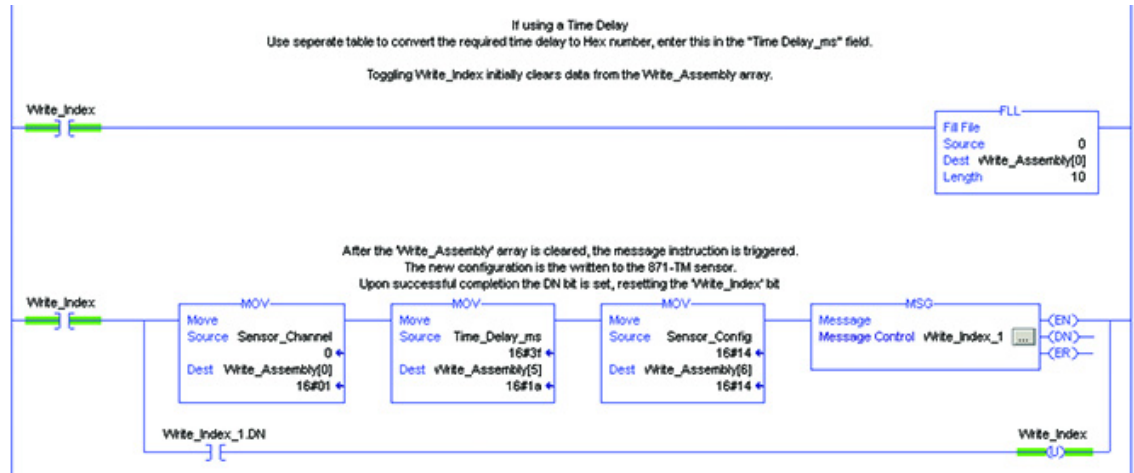

**Notes:**

## Troubleshooting

This guide is meant to help resolve common issues that occur when configuring the 871TM sensor.

### Checklist

Error	Cause	Remedy
Status indicator does not light up	The power supply is switched off.	Check to see if there is a reason for it to be switched off (installation or maintenance work, and so on). Switch on the power supply if appropriate.
Status indicator does not light up	The 4-pin M12 plug is not connected to the connector on the sensor	Connect the 4-pin M12 plug to the sensor and tighten the cap nut by hand.
Status indicator does not light up	Wiring fault in the splitter or control cabinet.	Check the wiring carefully and repair any wiring faults.
Status indicator does not light up	Supply cable to the sensor is damaged.	Replace the damaged cable.
No IO-Link connection to the device	No power supply	See error "Operating Indicator" status indicator does not light up.

**Notes:**

## Install the Add-on Profile

### Introduction

This appendix shows how to install the IO-Link Add-on Profile (AOP) with the RSLogix 5000® program. AOPs are files that users add to their Rockwell Automation library. These files contain the pertinent information for configuring a device that is added to the Rockwell Automation network.

The AOP simplifies the setup of devices because it presents the necessary fields in an organized fashion. The AOP allows you to install and configure their systems in a quick and efficient manner.

The AOP is a folder that contains numerous files for the device. It comes as an installation package.

### Perform the Installation

1. Download the latest IO-Link AOP file from the Add-on Profiles website. <https://download.rockwellautomation.com/esd/download.aspx?downloadid=addonprofiles>
2. Extract the AOP zip file, open the folder, and execute the “MPSetup” application file.



⌄ Checking activations...

3. Click Next to install the IO-Link module profiles.

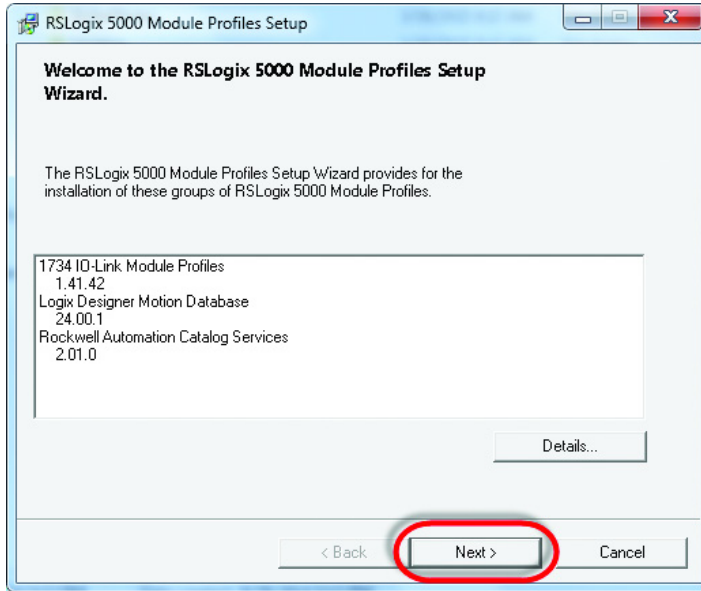

4. Accept the license agreements and click Next. Follow the module profiles installation wizard.

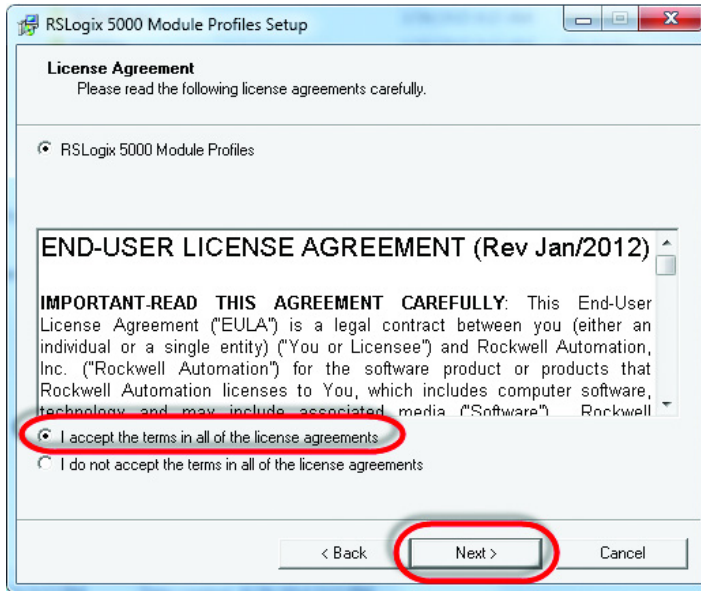



- Verify that the Install option is selected and click Next.

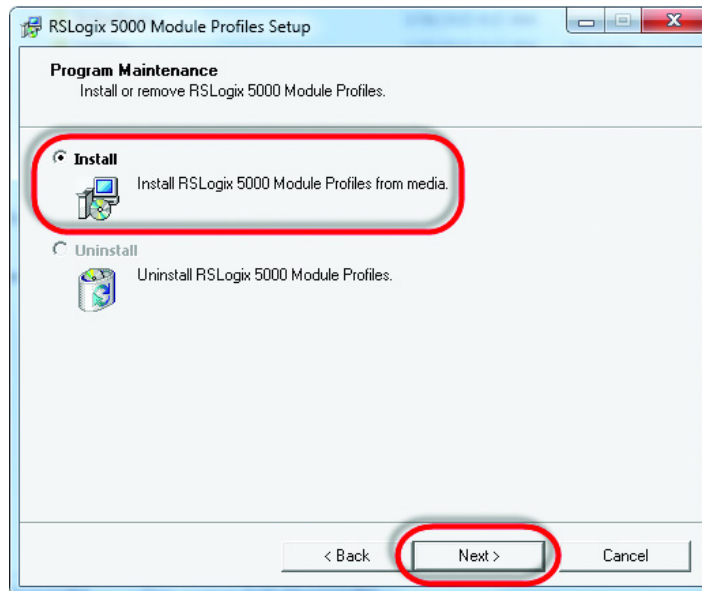

- Review the install details and click Install.

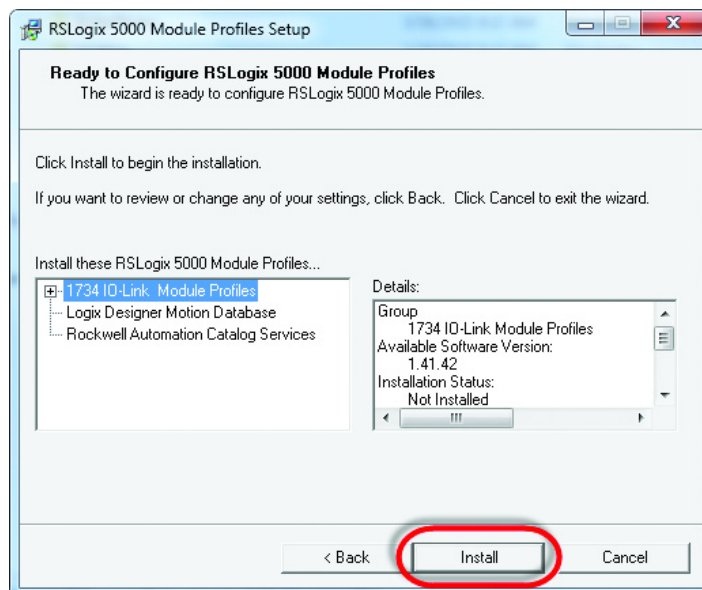

- 7. The installation process begins. This process can take several minutes.

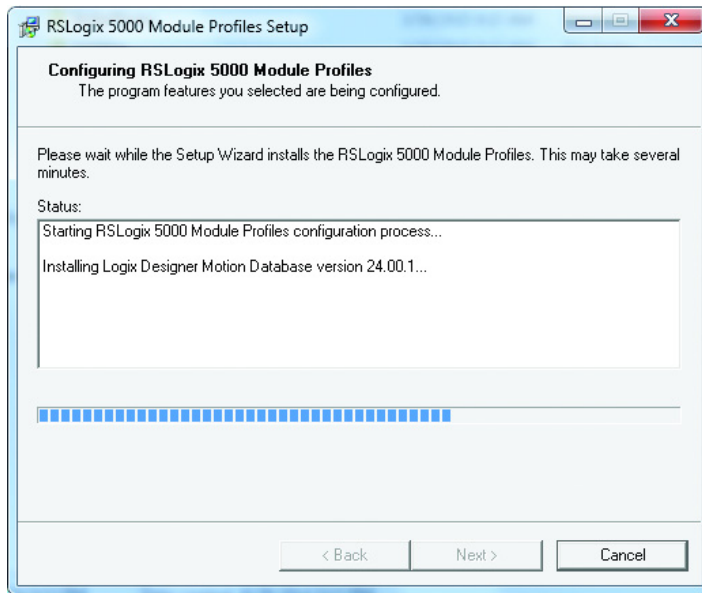

- 8. Once completed, click Next.

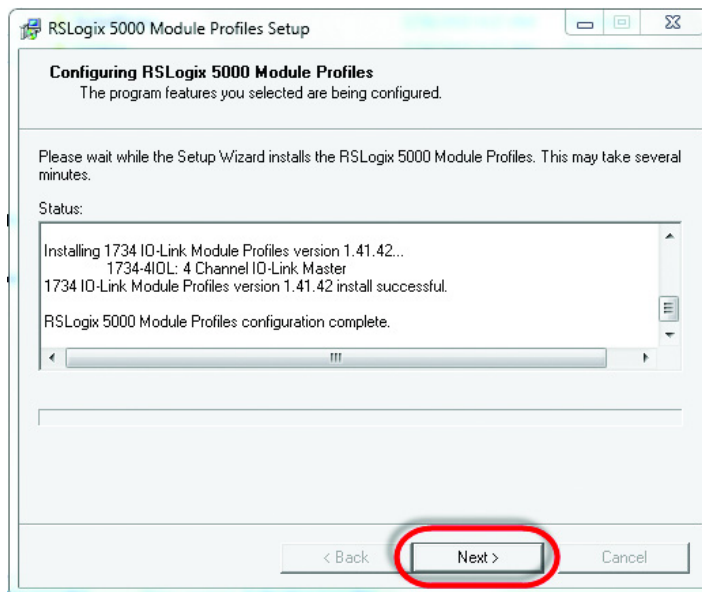

9. Click Finish and review the release notes for any additional information. The IO-Link AOP installation is completed.

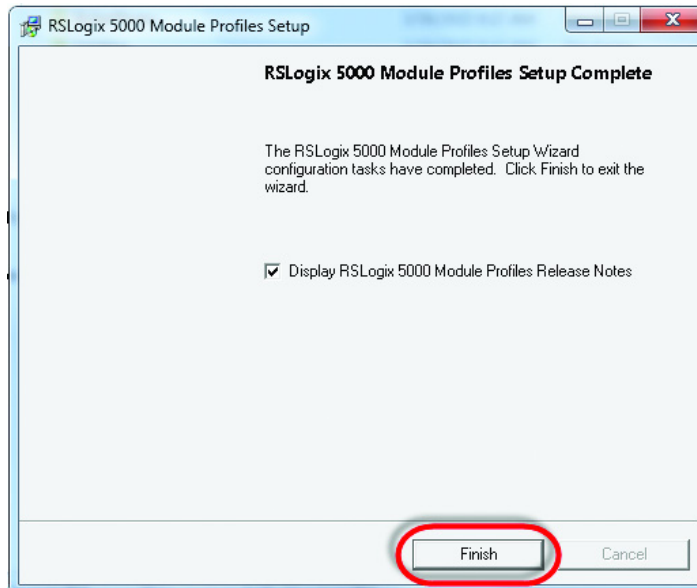

**Notes:**

## Device Parameters

When using Explicit Messages to Read/Write parameter values from/to the 871TM, you must know the Index Number, Data Type, and Size of the Data that is transmitted/received in the message. The attached table provides this information for each of the Device Parameters.

### Identification

Parameter Name	Index (Hex(Dec))	Subindex (Hex(Dec))	Access	Default	Allowed Value	Data Type (Length)
Direct Parameters 1.Vendor ID 2	0x00(0)	0x09(9)	Read-only	2 = Allen Bradley	2 = Allen Bradley	UIntegerT, bitLength = 8, bitOffset = 56
Direct Parameters 1.Device ID 3	0x00(0)	0x12(12)	Read-only	Blank	Depends on Device Variant	UIntegerT, bitLength = 8, bitOffset = 32

### Parameter

Parameter Name	Index (Hex(Dec))	Subindex (Hex(Dec))	Access	Default	Allowed Value	Data Type (Length)
.Polarity (changed viewable in SIO mode only)	0x01(1)	0x03(3)	Read/write	0 = Not Inverted (N.O.)	0 = Not Inverted (N.O.) 1 = Inverted (N.C.)	<u>871TM</u> - BooleanT, bitOffset = 84
Enable	0x01(1)	0x04(4)	Read/write	0 = On	0 = On, 1 = Off	<u>871TM</u> - BooleanT, bitOffset = 82
Mode	0x01(1)	0x05(5)	Read/write	0 = No Timer	0 = No Timer, 1 = Stretch On, 2 = On Delay, 3 = Delay and Stretch On	<u>871TM</u> - UIntegerT, bitOffset = 80, bitLength = 2
Multiplier	0x01(1)	0x02(2)	Read/write	0	0...63	<u>871TM</u> - UIntegerT, bitOffset = 88, bitLength = 6
Base Time	0x01(1)	0x01(1)	Read/write	0 = 0.1 ms	0 = 0.1 ms, 1 = 0.4 ms, 2 = 1.6 ms, 3 = 6.4 ms	<u>871TM</u> - UIntegerT, bitLength = 2, bitOffset = 94

## Diagnosis

Parameter Name	Index (Hex(Dec))	Subindex (Hex(Dec))	Access	Default	Allowed Value	Data Type (Length)
Direct Parameters 1.Min Cycle Time	0x00(0)	0x03(3)	Read-only	74		UIntegerT bitLength = 8 bitOffset = 104
Direct Parameters 1. Master Cycle Time	0x00(0)	0x02(2)	Read-only	74		UIntegerT bitLength = 8 bitOffset = 112
Direct Parameters 1.I0-Link Revision ID	0x00(0)	0x05(5)	Read-only	0x10		UIntegerT bitLength = 8 bitOffset = 88

## Process Data

Parameter Name	Index (Hex(Dec))	Subindex (Hex(Dec))	Access	Default	Allowed Value	Data Type (Length)
Triggered	DT_Process DataIn	0x02(2)	Read-only	–	0 = Not Triggered 1 = Triggered	BooleanT bitOffset = 0
MarginStatus	DT_Process DataIn	0x01(1)	Read-only	–	1 = Margin Good, 0 = Margin Low	BooleanT bitOffset = 1

## Error Codes

When an event occurs, the device signals the presence of the event to the master. The master then reads out the event. Events can be error messages and warnings/maintenance data. These messages provide insightful data from individual sensors. You can act on these messages and remedy any issue.

Error messages are transmitted from the device to the controller via the IO-Link master. The transmission of device parameters or events occurs independently from the cyclic transmission of process data.

### Error Codes

Bit	Value	Name	Description	Remedy
7	Always 0		–	
6	1	Invalid Process Data - LC Oscillator	The LC oscillator is not running (coil likely damaged/open)	Replace damaged sensor with exact sensor-Reference Automatic Device Configuration for sensor parameters
5	Always 0		–	
4	Always 0		–	
3	Always 0		–	
2	Always 0		–	
1	Always 0		–	
0	Always 0		–	

## Location of Error Codes

In the “Controller Tags” view within Studio 5000 Logix Designer®, the 871TM event appears in the “Status” section view. This value changes from a zero to a one.

**IMPORTANT** In the Controller Tag view below, the 871TM supported event is depicted as the following:  
 GREEN box = Status.Ch#DataInvalid, which refers to the 871TM Bit 6 event

my_aentr:1:I.Status		{...}	{...}		AB:1734_4IOL_Struct_Status:1:0
my_aentr:1:I.Status.Ch0Fault	0		Decimal		BOOL
my_aentr:1:I.Status.Ch0ConnectionFaulted	0		Decimal		BOOL
my_aentr:1:I.Status.Ch0ConfigurationInProgress	0		Decimal		BOOL
my_aentr:1:I.Status.Ch0ConfigurationFault	0		Decimal		BOOL
my_aentr:1:I.Status.Ch0KeyingFault	0		Decimal		BOOL
my_aentr:1:I.Status.Ch0ShortCircuit	0		Decimal		BOOL
my_aentr:1:I.Status.Ch0DataInvalid	0		Decimal		BOOL
my_aentr:1:I.Status.Ch0PowerFault	0		Decimal		BOOL
my_aentr:1:I.Status.Ch0ClampAlarm	0		Decimal		BOOL



## Numerics

- 1734-4IOL IO-Link AOP**
  - review 49
- 871TM IODD**
  - register 41
- 871TM long-range sensor with IO-Link**
  - overview 17
- 871TM sensor**
  - configure for IO-Link mode 25
  - connect to IO-Link master 35
  - IO-Link features 23

## A

- Add-on Profile**
  - install 71
- AOP**
  - installation 34
- assign**
  - device parameters 21
- automatic device configuration** 18

## B

- behavior**
  - device parameter 49

## C

- cable style**
  - dimensions 14
- checklist**
  - troubleshooting 69
- code**
  - sample 57
- common tab** 50
- configuration**
  - automatic device 18
- configure**
  - IO-Link master 31
  - sensor with Studio 5000 57
- connect**
  - 871TM to IO-Link master 35
- controller tags** 55
- correction factors** 11
- correlation** 23
- create** 27

## D

- data**
  - decipher 62
- data types**
  - device data 20
  - events 20
  - IO-Link 19
  - process data 19
  - value status 19
- decipher**
  - data 62
- descriptive tags** 18
- device data** 20
- device parameter behavior** 49
- device parameters** 77
  - assign 21
  - diagnosis 78
  - identification 77
  - parameter 77
  - process data 78
- device profiles** 18
- diagnosis tab** 54
- diagnostics**
  - real-time 17
- dimensions** 14
  - cable style 14
  - micro QD style 14
  - pico QD style (3-pin) 15
  - pico QD style (4-pin) 15

## E

- error codes** 79
  - location 80
- events** 20
- example**
  - set up hardware 26
- explicit message**
  - read 871TM configuration 61
  - write configuration to 871TM 63

## F

- factory reset** 67
- features** 10

## H

- hardware** 25
- health status**
  - sensor 18
- how does IO-Link work** 18

**I**

- identification tab** 51
- install**
  - Add-on Profile 71
- installation** 13
  - AOP 34
- integration** 17, 22
- IO-Link**
  - 871TM sensor configuration 25
  - data types 19
  - how 18
  - system response time 19
  - what 17
  - why 17
- IO-Link master**
  - configure 31

**M**

- micro QD style**
  - dimensions 14
- mode**
  - switching timer 52
- modes**
  - operating 9
- mounting** 13

**O**

- operating modes** 9
- operation** 61
- overview** 9
  - 871TM long-range sensor with IO-Link 17

**P**

- parameter tab** 51
- parameters**
  - device 77
- pico QD style (3-pin)**
  - dimensions 15
- pico QD style (4-pin)**
  - dimensions 15
- polarity** 52
- premier integration** 22
- process data** 19
- product**
  - description 9
  - features 10
  - overview 9
  - specifications 10
- project** 27
  - create 27

**R**

- read**
  - 871TM configuration 61
- real-time diagnostics and trending** 17
- register**
  - 871TM IODD 41
- reset**
  - sensor to default 67
- response time** 19
- review**
  - 1734-4IOL IO-Link AOP 49

**S**

- sample code** 57
- seamless integration** 17
- sensor**
  - health status 18
- set up hardware**
  - example 26
- software** 25
- specifications** 10
- status**
  - sensor health 18
- Studio 5000**
  - configure sensor 57
- switching timer mode** 52

**T**

- tab**
  - common 50
  - diagnosis 54
  - identification 51
  - parameter 51
- tags**
  - controller 55
  - descriptive 18
- transmission**
  - quality 19
  - rates 18
- trending**
  - real-time 17
- troubleshooting** 69
  - checklist 69

**U**

- user interface** 13

**V**

- value status** 19

**W**

- what is IO-Link** 17
- why IO-Link** 17
- wiring** 15
- write**
  - configuration to 871TM 63



# Rockwell Automation Support

Use these resources to access support information.

<b>Technical Support Center</b>	Find help with how-to videos, FAQs, chat, user forums, and product notification updates.	<a href="http://rok.auto/support">rok.auto/support</a>
<b>Knowledgebase</b>	Access Knowledgebase articles.	<a href="http://rok.auto/knowledgebase">rok.auto/knowledgebase</a>
<b>Local Technical Support Phone Numbers</b>	Locate the telephone number for your country.	<a href="http://rok.auto/phonesupport">rok.auto/phonesupport</a>
<b>Literature Library</b>	Find installation instructions, manuals, brochures, and technical data publications.	<a href="http://rok.auto/literature">rok.auto/literature</a>
<b>Product Compatibility and Download Center (PCDC)</b>	Download firmware, associated files (such as AOP, EDS, and DTM), and access product release notes.	<a href="http://rok.auto/pcdc">rok.auto/pcdc</a>

## Documentation Feedback

Your comments help us serve your documentation needs better. If you have any suggestions on how to improve our content, complete the form at [rok.auto/docfeedback](http://rok.auto/docfeedback).

## Waste Electrical and Electronic Equipment (WEEE)



At the end of life, this equipment should be collected separately from any unsorted municipal waste.





Rockwell Automation maintains current product environmental information on its website at [rok.auto/pec](http://rok.auto/pec).

Allen-Bradley, CompactLogix, ControlLogix, expanding human possibility, Integrated Architecture, POINT I/O, Rockwell Automation, Rockwell Software, RSLogix 5000, Studio 5000, and Studio 5000 Logix Designer are trademarks of Rockwell Automation, Inc.

EtherNet/IP is a trademark of ODVA, Inc.

Trademarks not belonging to Rockwell Automation are property of their respective companies.

Rockwell Otomasyon Ticaret A.Ş. Kar Plaza İş Merkezi E Blok Kat:6 34752, İçerenköy, İstanbul, Tel: +90 (216) 5698400 EEE Yönetmeliğine Uygundur

Connect with us.    

**rockwellautomation.com** ————— expanding **human possibility**<sup>™</sup>

AMERICAS: Rockwell Automation, 1201 South Second Street, Milwaukee, WI 53204-2496 USA, Tel: (1) 414.382.2000, Fax: (1) 414.382.4444

EUROPE/MIDDLE EAST/AFRICA: Rockwell Automation NV, Pegasus Park, De Kleetlaan 12a, 1831 Diegem, Belgium, Tel: (32) 2 663 0600, Fax: (32) 2 663 0640

ASIA PACIFIC: Rockwell Automation, Level 14, Core F, Cyberport 3, 100 Cyberport Road, Hong Kong, Tel: (852) 2887 4788, Fax: (852) 2508 1846

Publication 871TM-UM002D-EN-P - February 2021

Supersedes Publication 871TM-UM002C-EN-P - October 2017

Copyright © 2021 Rockwell Automation, Inc. All rights reserved. Printed in the U.S.A.