

USB A female to B female keystone coupler

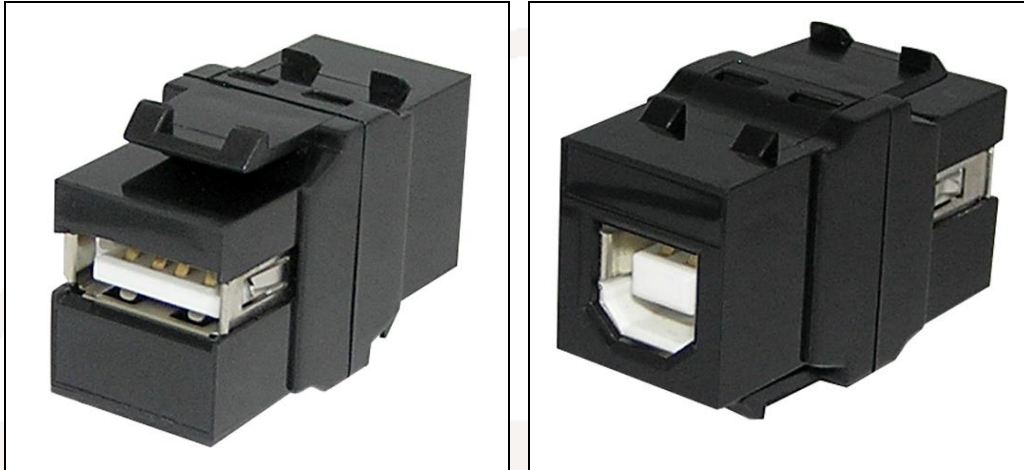

USB A to B keystone coupler (KCUABbk)

This USB2.0 keystone coupler can be used to convert a USB A to USB B. With its standardised dimensions it can be used for easy snap-in mounting in a keystone patch panel, face plate or surface-mount box.

Features

- USB 2.0 keystone coupler (A female to B female type connectors)
- Allows conversion of USB B male into USB A female and vice versa
- Reversible coupler easily mounts both ways round in industry standard keystone patch panels
- Supports USB 1.1 and USB 2.0 devices
- Available as part of our innovative new panel mount coupler (KCUABbkpm), designed for easy mounting on panels of virtually any thickness
- White version also available to order

Specifications:

- Dimensions: approx 34.5x16.5x23mm
- Housing: ABS UL94V-0
- Colour: black
- Connection: USB2.0 A female / B female

ROHS Compliant

Code: KCUABbk

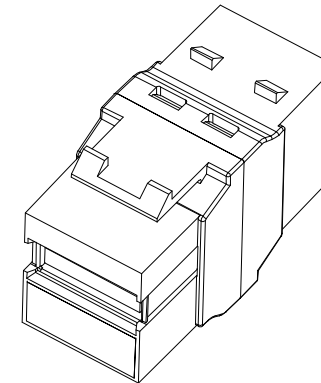
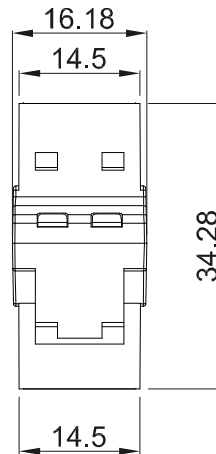
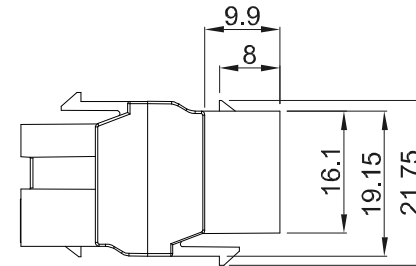
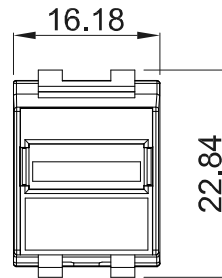
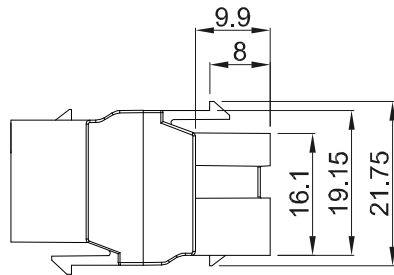
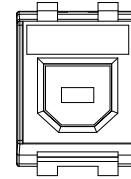
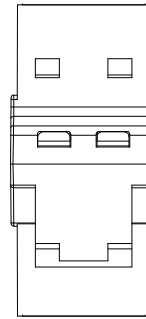

TOLERANCE	
.XXXX	----
.XXX	0.10
.XX	0.25
.X	0.38

MATERIAL	
CATEGORY	USB (A) FEMALE TO USB (B) FEMALE ADAPTER
HOUSING	ABS UL94V-0
CONNECTOR	BODY : ZINC ALLOY WITH NICKEL PLATING
	CONTACT : BRASS WITH FLASH GOLD PLATING
COLOUR	BLACK
ELECTRICAL	IMPEDANCE : 50Ω
	FREQUENCY : 0~1 GHZ
	VOLTAGE RATING : 500 VOL TS MS