

Application Guidelines

Sources of EMI

Electromagnetic interference occurs naturally from terrestrial sources such as lightning discharges, precipitation, and sand and dust storms, in addition to cosmic noise emanating from sources within and outside our solar system. Man-made sources include power lines, rotating machinery, ignition systems, television and radio receivers, fluorescent lights, power amplifiers, computing devices and transmitters of all types.

Interference Suppression

Filter networks suppress electromagnetic interference in two basic ways. The capacitor elements shunt the interference to ground, and the series inductor elements raise the impedance of the line making the shunt capacitor elements even more effective.

Capacitor Elements

The types of capacitors used in API's line of Spectrum Control filters are often referred to as feed-through capacitors due to their physical geometry.

The feed-through design results in greatly reduced self-inductance compared to standard leaded capacitors. Also, this design effectively prevents radiation from the input coupling directly with the output of the capacitor, unlike leaded or chip capacitors. The combination of low inductance and high input/output isolation provides excellent shunting of EMI for frequencies up to and beyond 1 GHz.

The simplest feed-through type is a ceramic tube that may have buried electrodes and can be constructed as a single capacitor or as two capacitors, as used in a Pi section filter. This type of device can have capacitance values from 10 pF to 0.1 μ F and typical working voltage ratings up to 2500 VDC. Due to the simple construction, these capacitors are very efficient at frequencies up to 10 GHz and exhibit no pronounced resonances.

Multilayer monolithic discoidal capacitors are used for very high capacitance parts in standard sizes or for smaller filters where the required capacitance cannot be achieved by a ceramic tube. This type of capacitor consists of alternate layers of opposite polarity electrodes separated by a ceramic dielectric. Typical capacitance values from 100 pF to 10 μ F are available with working voltages up to 400 VDC.

Inductive Elements

Ferrite sleeves are used with tubular capacitors since they can be conveniently accommodated inside the tube to provide a very compact filter. They are also used with discoidal capacitors in some applications. Wound inductors are used with discoidal capacitors to provide very high performance filters.

Multilayer Discoidal Capacitor

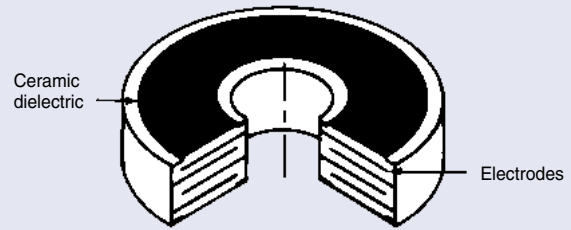

Embedded Electrode Tubular Capacitor

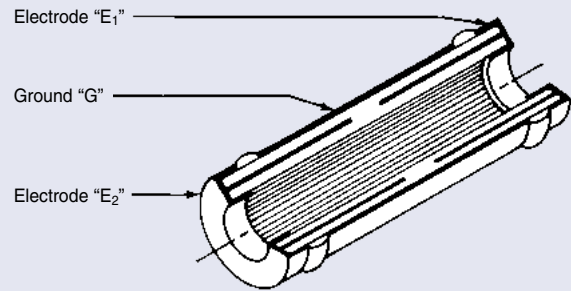

Resin Sealed Filter

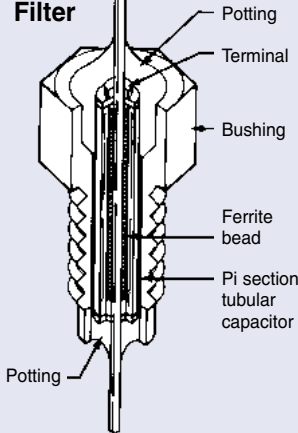

Hermetically Sealed Filter

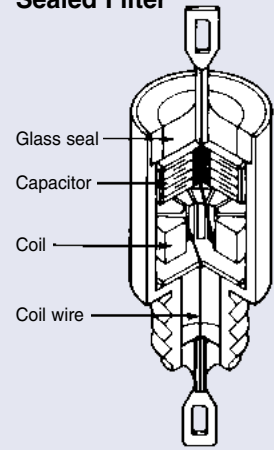

Circular Filtered Connector

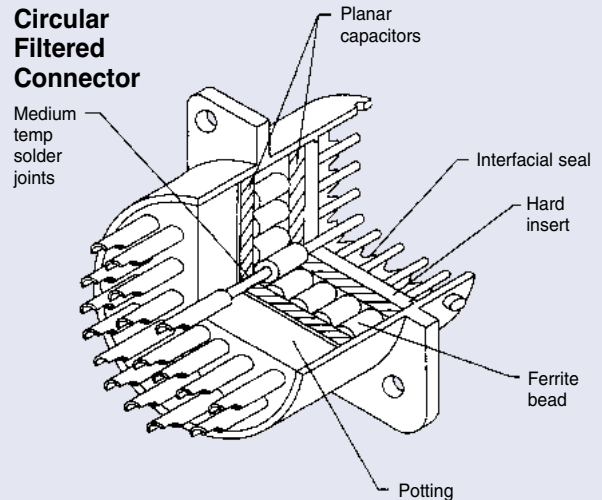

Application Guidelines

Low Pass EMI filters are available in the following circuit configurations:

C Filter

The C filter is a three terminal feed-through capacitor. It is used to attenuate high frequency signals.

L Filter

An L filter consists of one inductive element and one capacitive element. This type of filter can offer high impedance or low impedance input depending upon its orientation in the circuit. It is most commonly used in applications where one has a high impedance load and a low impedance source (see LT), or where one has a high impedance source and a low impedance load (see LB).

Pi Filter

The Pi filter contains two capacitive elements and one inductive element. It presents a low impedance to both the source and the load. Because of the additional element, it provides better high frequency performance than the C or L configurations. Due to the possibility of 'ringing', Pi filters are not recommended for switching applications.

Transient Suppression Pi Filter

The transient suppression Pi filter consists of a Pi filter with a transient suppressor at the input to the filter. The filter supplies the high frequency performance of the Pi filter with the added protection of the transient suppressor to protect the circuit from voltage spikes on the line.

T Filter

The T filter consists of two inductive elements and one capacitive element. This circuit configuration presents a high impedance input from either end. It has similar filter performance to the Pi circuit configurations. It does not have the ringing characteristic of the Pi filter and can be used in switching applications.

Multisection Filter (Double T)

API's multielement filters are designed for optimum insertion loss in circuits with a relatively low source and load impedance. These filters are also recommended in any application where a high degree of filtering is required. The unit utilizes an inductor input for the best compatibility with a MIL-STD-461 test setup (10 μ F feed-through capacitor).

Schematics

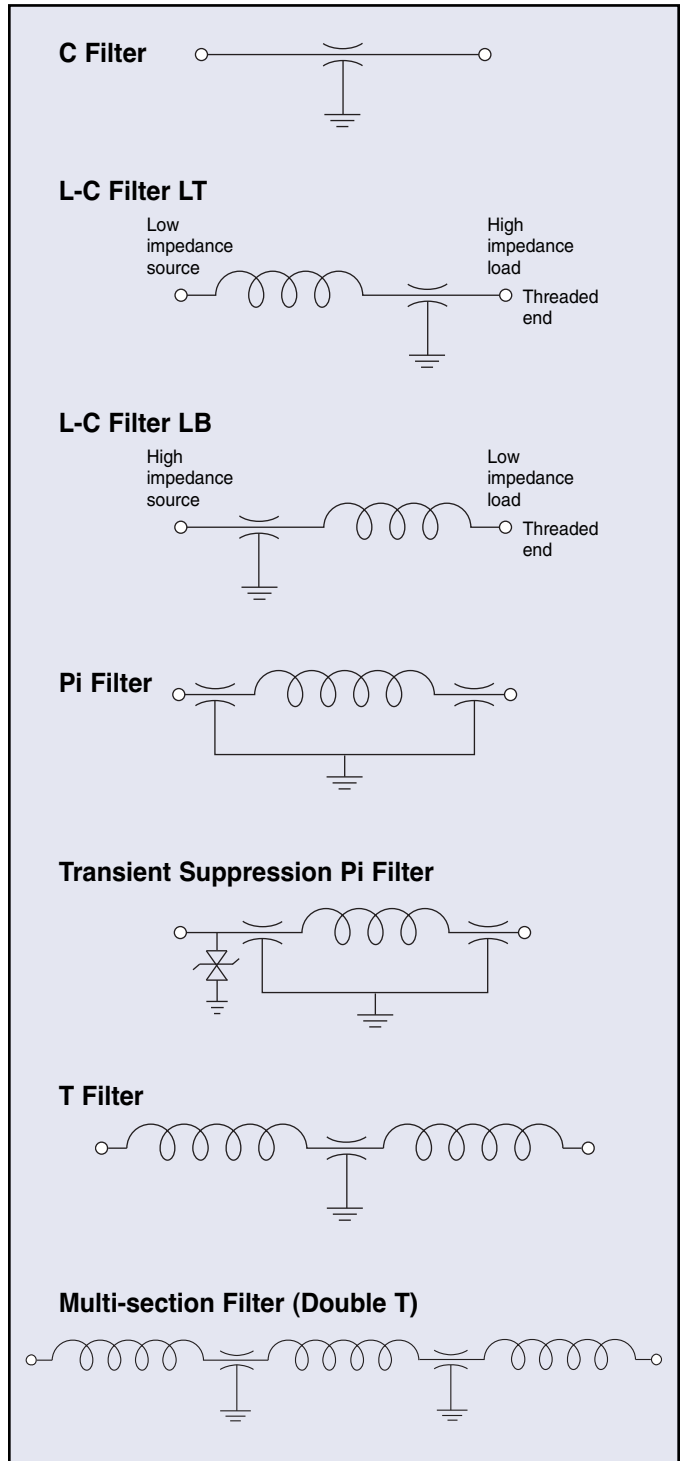

Application Guidelines

Insertion Loss Measurement

Insertion loss (IL) is a measure of the effectiveness of a filter. It is defined as the ratio of the voltage (E1) across the circuit load without the filter and the voltage (E2) across the load with the filter. Since insertion loss is dependent on the source and load impedance in which the filter is to be used, IL measurements are defined for a matched 50 ohm system. The insertion loss is measured in decibels (dB) and defined as follows:

$$IL \text{ (dB)} = 20 \log \left[\frac{E1}{E2} \right]$$

Circuit Impedance vs. Insertion Loss

In practical circuit applications the source and load impedances may be quite different from 50 ohms. If these impedances are known, API engineering can provide information on the expected insertion loss or an estimate can be made using the following formula:

$$IL \text{ (dB)} = 20 \log \left[1 + \frac{Zs Zi}{Zt (Zs + Zi)} \right]$$

Where Zs = Source impedance in ohms
 Zi = Load impedance in ohms
 Zt = Transfer impedance in 50 ohm system

Example:

1. System source and load impedances are 100 ohms and 600 ohms respectively.
2. Selected filter has insertion loss of 50 dB at 100 MHz in a 50 ohm system.
3. From the IL vs Transfer Impedance curve (right) the transfer impedance is 0.08 ohms.

$$4. IL = 20 \log \left[1 + \frac{100 \times 600}{0.08 (100+600)} \right]$$

$$= 20 \log 1072$$

$$= 61 \text{ dB}$$

Insertion Loss (dB)

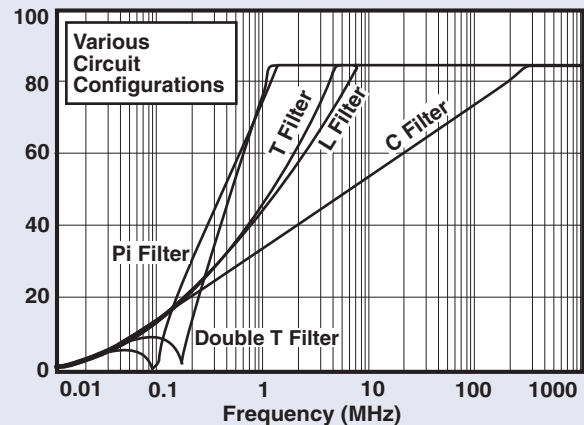
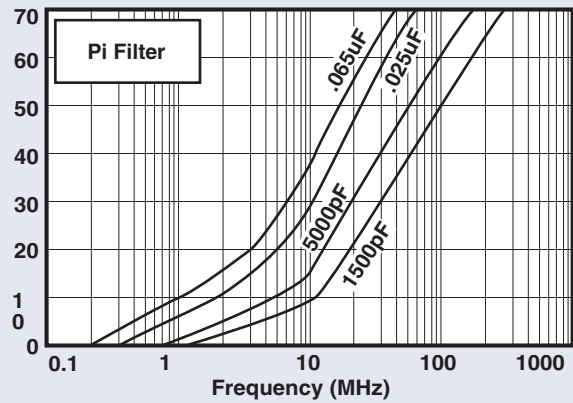
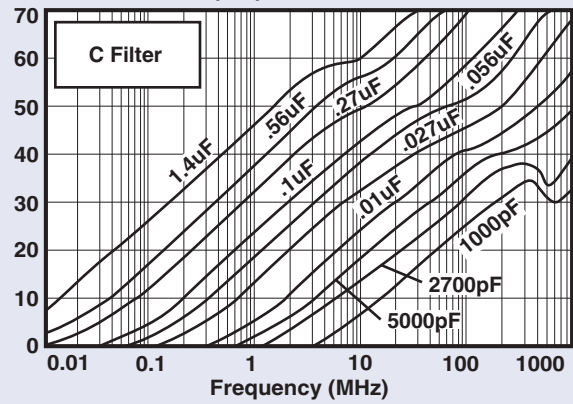

Transfer Impedance Graph

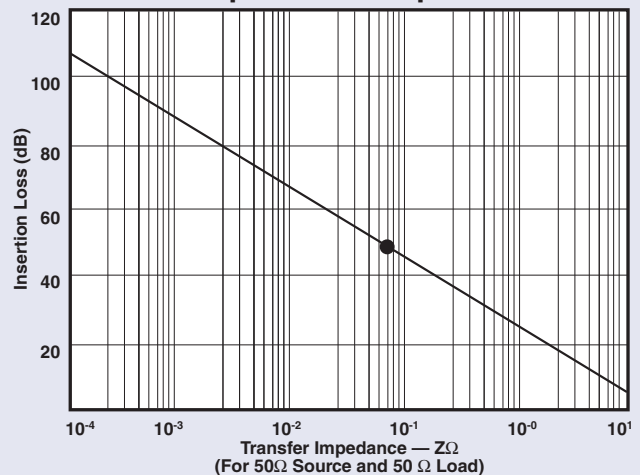

Hermetically Sealed Threaded Case Filters

This series of filters features hermetic glass seals and high EMI filtering performance. They are excellent for critical applications that demand high reliability in the toughest environmental conditions and provide broad-band high performance EMI filtering from 10 KHz to over 10 GHz.

Features

- MIL-F-15733 and MIL-F-28861, DSCC 84084 QPL filters available
- Popular .375", .410" and .690" case diameters
- Voltage ratings from 50 V to 400 VDC/240 AC, 400 Hz
- Impervious to high moisture environments, solvents and severe environmental conditions
- High temperature terminal construction
- D-slotted bushings
- High reliability testing available



Thread length: A - 0.187 (4.76) B - 0.312 (7.92)

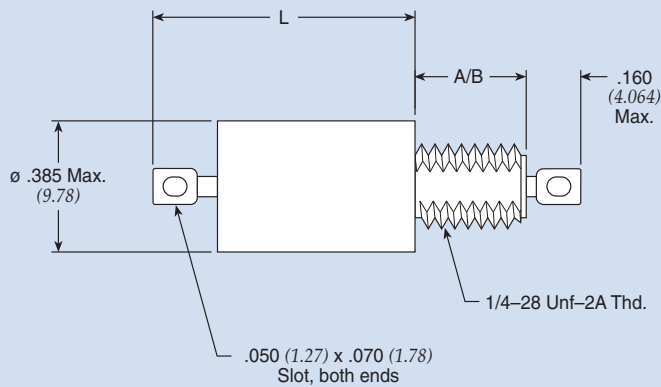

Figure 1

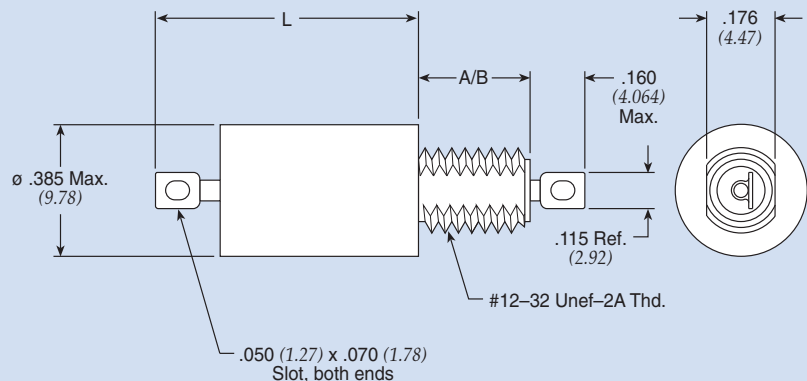

Figure 2

Dimensions in inches (mm)

Note: ø .410 Max. for M28861 parts

Hermetically Sealed Threaded Case Filters

.375 ø C Circuit Standard

| Part Number | MIL No | See Pg. LP26 for Fig. | Rated Voltage | | | | I Amp | Min Cap µF | DCR Max Ohms | Max L | | Thd Lgth | Minimum Insertion Loss (dB) | | | | | | |
|-----------------|--------|-----------------------|---------------|----|-------|-----|-------|------------|--------------|-------|----------|----------|-----------------------------|---------|---------|-------|--------|---------|-------|
| | | | 85°C | | 125°C | | | | | In | (mm) | | 30 KHz | 150 KHz | 300 KHz | 1 MHz | 10 MHz | 100 MHz | 1 GHz |
| | | | DC | AC | DC | AC | | | | | | | | | | | | | |
| † 54-367-008 | — | 1 | 80 | — | 50 | — | 15 | 1.400 | 0.005 | 0.387 | (9.830) | A | 15 | 28 | 33 | 44 | 60 | 70 | 70 |
| 54-370-007 | — | 1 | 80 | — | 50 | — | 15 | 2.800 | 0.005 | 0.576 | (14.630) | A | 20 | 34 | 39 | 50 | 60 | 70 | 70 |
| 54-371-001 | — | 1 | 80 | — | 50 | — | 15 | 4.000 | 0.005 | 0.688 | (17.475) | A | 26 | 40 | 46 | 55 | 60 | 70 | 70 |
| 54-367-005 | — | 1 | 150 | — | 100 | — | 15 | 0.450 | 0.005 | 0.387 | (9.830) | A | 6 | 19 | 25 | 36 | 55 | 70 | 70 |
| † 9920-100-6002 | — | 1 | 200 | — | 150 | 125 | 15 | 0.150 | 0.005 | 0.387 | (9.830) | A | — | 6 | 15 | 26 | 42 | 55 | 70 |
| 54-367-007 | — | 1 | 250 | — | 200 | 125 | 15 | 0.015 | 0.005 | 0.387 | (9.830) | A | — | — | — | 6 | 25 | 45 | 50 |
| † 54-367-006 | — | 1 | 250 | — | 200 | 125 | 15 | 0.250 | 0.005 | 0.387 | (9.830) | A | — | 14 | 19 | 30 | 50 | 65 | 70 |
| 54-370-006 | — | 1 | 250 | — | 200 | 125 | 15 | 0.500 | 0.005 | 0.630 | (16.002) | A | 7 | 20 | 28 | 39 | 55 | 70 | 70 |
| 9923-100-6004 | — | 1 | 400 | — | 400 | 240 | 15 | 0.060 | 0.005 | 0.415 | (10.541) | A | — | 5 | 10 | 18 | 38 | 55 | 70 |

.375 ø C Circuit MIL Qualified (See MIL index on pages CF9-11 for complete MIL part number listing)

| Part Number | M15733 M28861 MIL No | See Pg. LP26 for Fig. | Rated Voltage | | | | I Amp | Min Cap µF | DCR Max Ohms | Max L | | Thd Lgth | Minimum Insertion Loss (dB) | | | | | | |
|-------------|----------------------|-----------------------|---------------|----|-------|-----|-------|------------|--------------|-------|----------|----------|-----------------------------|---------|---------|-------|--------|---------|-------|
| | | | 85°C | | 125°C | | | | | In | (mm) | | 30 KHz | 150 KHz | 300 KHz | 1 MHz | 10 MHz | 100 MHz | 1 GHz |
| | | | DC | AC | DC | AC | | | | | | | | | | | | | |
| 54-367-054 | 1-012◇ | 1 | — | — | 50 | — | 15 | 1.200 | 0.008 | 0.410 | (10.414) | B | 15 | 28 | 33 | 40 | 40 | 70 | 70 |
| 54-367-049 | 1-002◇ | 1 | — | — | 50 | — | 15 | 1.200 | 0.008 | 0.410 | (10.414) | A | 15 | 28 | 33 | 40 | 40 | 70 | 70 |
| 54-370-032 | 49-0008 | 1 | — | — | 50 | — | 15 | 2.100 | 0.010 | 0.576 | (14.630) | A | 20 | 33 | 40 | 50 | 65 | 70 | 70 |
| 54-367-055 | 1-014◇ | 1 | — | — | 70 | — | 15 | 0.700 | 0.008 | 0.410 | (10.414) | B | 10 | 24 | 30 | 40 | 40 | 64 | 70 |
| 54-370-030 | 34-0035 | 2 | — | — | 100 | — | 10 | 0.300 | 0.004 | 0.474 | (12.040) | A | 7 | 19 | 25 | 35 | 55 | 70 | 70 |
| 54-367-051 | 1-006◇ | 1 | — | — | 100 | — | 15 | 0.450 | 0.008 | 0.410 | (10.414) | A | 6 | 19 | 25 | 36 | 40 | 60 | 70 |
| 54-367-056 | 1-016◇ | 1 | — | — | 100 | — | 15 | 0.450 | 0.008 | 0.410 | (10.414) | B | 6 | 19 | 25 | 36 | 40 | 60 | 70 |
| 54-367-057 | 1-018◇ | 1 | — | — | 150 | — | 15 | 0.250 | 0.008 | 0.410 | (10.414) | B | — | 14 | 20 | 31 | 40 | 56 | 70 |
| 54-367-053 | 1-010◇ | 1 | — | — | 200 | 125 | 15 | 0.150 | 0.008 | 0.410 | (10.414) | A | — | 10 | 16 | 26 | 40 | 52 | 70 |
| 54-367-058 | 1-020◇ | 1 | — | — | 200 | 125 | 15 | 0.150 | 0.008 | 0.410 | (10.414) | B | — | 10 | 16 | 26 | 40 | 52 | 70 |
| 54-370-034 | 49-0010 | 1 | — | — | 330 | — | 15 | 0.062 | 0.004 | 0.680 | (17.272) | A | — | 2 | 7 | 17 | 37 | 55 | 70 |

† Also available through authorized distributors.

Hermetically Sealed Threaded Case Filters

.375 ø L Circuit

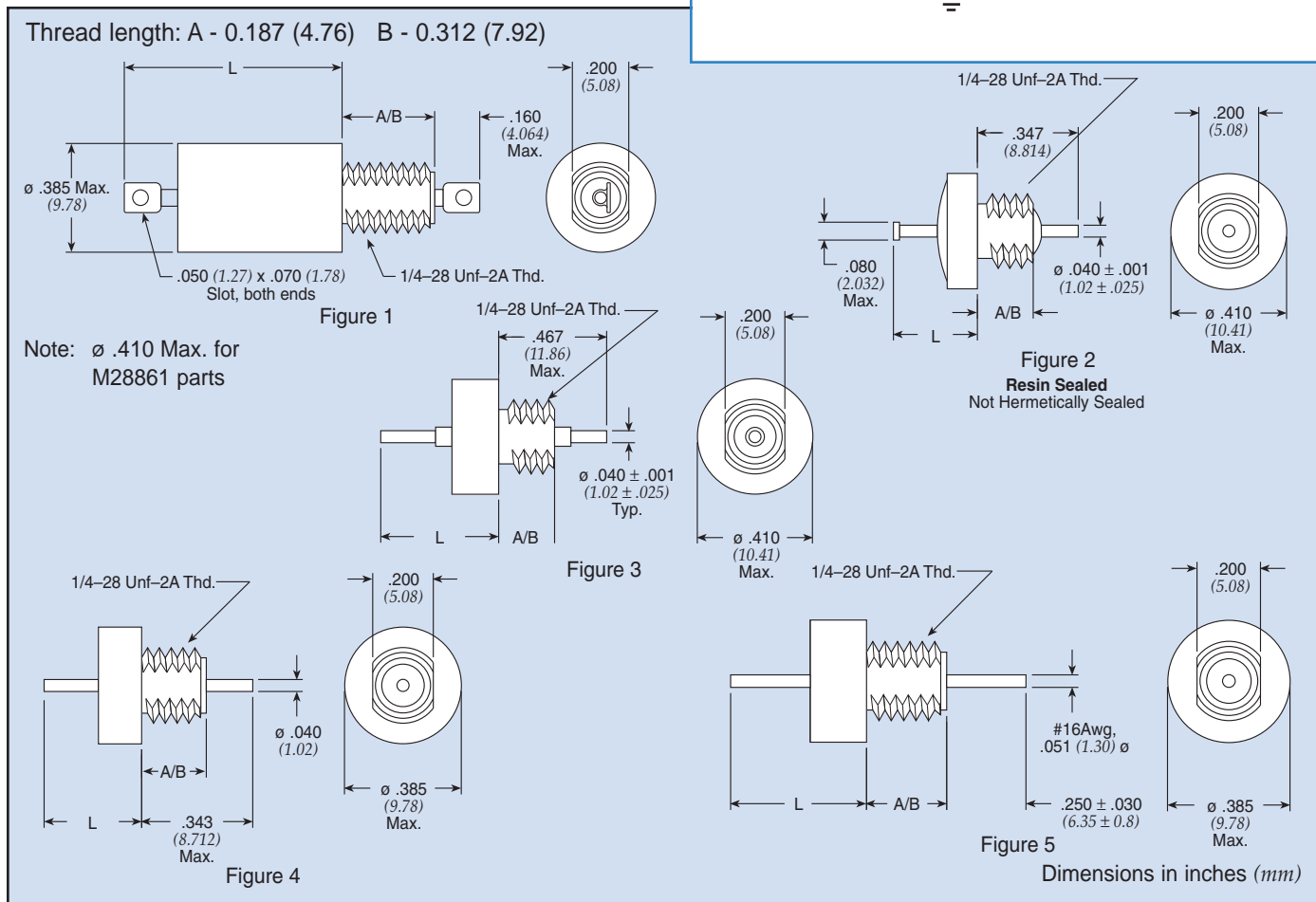

L-C Filter LT

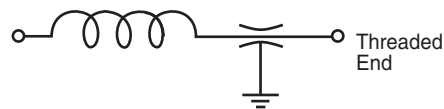

L-C Filter LB

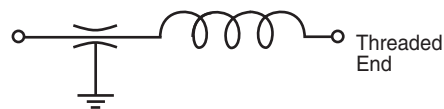

.375 ø L Standard Low Profile

| Part Number | MIL No | Figure | Rated Voltage | | | | I Amp | Min Cap µF | DCR Max Ohms | CKT | Max L In | Max L (mm) | Thd Lgth | Minimum Insertion Loss (dB) | | | | | | |
|-----------------|--------|-----------------|---------------|----|----|----|-------|------------|--------------|-----|----------|------------|----------|-----------------------------|---------|---------|-------|--------|---------|-------|
| | | | DC | AC | DC | AC | | | | | | | | 30 KHz | 150 KHz | 300 KHz | 1 MHz | 10 MHz | 100 MHz | 1 GHz |
| † 9051-100-0000 | — | 1 | 80 | — | 50 | — | 15 | 1.200 | 0.005 | LB | 0.370 | (9.398) | A | 15 | 25 | 34 | 44 | 60 | 70 | 70 |
| † 51-359-001 € | — | 1 | 80 | — | 50 | — | 15 | 1.400 | 0.005 | LB | 0.370 | (9.398) | A | 15 | 28 | 33 | 44 | 60 | 70 | 70 |
| SCI-1021-000 | — | 2* | 80 | — | 50 | — | 15 | 1.400 | 0.003 | LB | 0.280 | (7.112) | A | 15 | 28 | 33 | 44 | 60 | 70 | 70 |
| † 9053-100-0001 | — | 1 | 80 | — | 50 | — | 15 | 1.400 | 0.005 | LB | 0.370 | (9.398) | A | 15 | 25 | 34 | 44 | 60 | 70 | 70 |
| † 51-717-001 € | — | 2* | 80 | — | 50 | — | 15 | 1.400 | 0.005 | LB | 0.325 | (8.255) | A | 15 | 28 | 33 | 44 | 60 | 70 | 70 |
| 51-344-006 | — | 4 | 80 | — | 50 | — | 15 | 1.400 | 0.005 | LB | 0.330 | (8.382) | A | 15 | 28 | 33 | 44 | 60 | 70 | 70 |
| † SCI-1020-000 | — | 1 | 80 | — | 50 | — | 15 | 1.400 | 0.003 | LB | 0.370 | (9.398) | A | 15 | 28 | 33 | 44 | 60 | 70 | 70 |
| SCI-1021-020 | — | 2 ^{0*} | 80 | — | 50 | — | 15 | 1.400 | 0.003 | LB | 0.280 | (7.112) | B | 15 | 28 | 33 | 44 | 60 | 70 | 70 |
| † SCI-1020-020 | — | 1 | 80 | — | 50 | — | 15 | 1.400 | 0.003 | LB | 0.370 | (9.398) | B | 15 | 28 | 33 | 44 | 60 | 70 | 70 |
| SCI-1150-001 | — | 1 | 80 | — | 50 | — | 15 | 2.800 | 0.003 | LB | 0.450 | (11.430) | B | 20 | 34 | 40 | 49 | 60 | 70 | 70 |
| 9051-101-0018 | — | 5 | 80 | — | 50 | — | 25 | 1.400 | 0.001 | LB | 0.450 | (11.430) | A | 15 | 25 | 34 | 44 | 60 | 70 | 70 |
| † 9053-100-0008 | — | 1 | 100 | — | 70 | — | 15 | 0.700 | 0.005 | LB | 0.370 | (9.398) | A | 9 | 20 | 29 | 39 | 52 | 70 | 70 |

* Part is resin sealed, this is not a hermetic part.

† Also available through authorized distributors.

€ Also available through authorized European distributors/agents.

◇ Note: 0.462" (11.73mm) length from mounting surface to end of lead — not 0.347" (8.8mm).

Hermetically Sealed Threaded Case Filters

L-C Filter LT

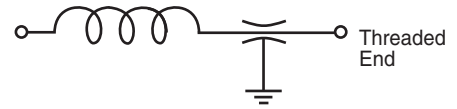

L-C Filter LB

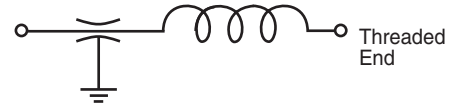

.375 ø L Standard Low Profile *continued*

| Part Number | MIL No | See Pg. LP28 for Fig | Rated Voltage | | | | I Amp | Min Cap µF | DCR Max Ohms | CKT | Max L | | Thd Lgth | Minimum Insertion Loss (dB) | | | | | | | |
|-----------------|--------|----------------------|---------------|-----|-------|-----|-------|------------|--------------|-----|-------|----------|----------|-----------------------------|---------|---------|-------|--------|---------|-------|--|
| | | | 85°C | | 125°C | | | | | | In | (mm) | | 30 KHz | 150 KHz | 300 KHz | 1 MHz | 10 MHz | 100 MHz | 1 GHz | |
| | | | DC | AC | DC | AC | | | | | | | | | | | | | | | |
| † 9050-100-0008 | — | 2* | 100 | — | 70 | — | 15 | 0.750 | 0.005 | LB | 0.325 | (8.255) | A | 9 | 20 | 29 | 39 | 52 | 70 | 70 | |
| † 9053-100-0002 | — | 1 | 150 | — | 100 | — | 15 | 0.500 | 0.005 | LB | 0.370 | (9.398) | A | 4 | 12 | 21 | 31 | 48 | 70 | 70 | |
| SCI-1250-001 | — | 1 | 150 | — | 100 | — | 15 | 0.500 | 0.003 | LB | 0.450 | (11.430) | B | 8 | 20 | 25 | 34 | 50 | 64 | 70 | |
| € SCI-2150-000 | — | 1 | 150 | — | 100 | — | 15 | 1.000 | 0.003 | LB | 0.450 | (11.430) | A | 10 | 25 | 30 | 41 | 56 | 70 | 70 | |
| SCI-2150-001 | — | 1 | 150 | — | 100 | — | 15 | 1.000 | 0.003 | LB | 0.450 | (11.430) | B | 10 | 25 | 30 | 41 | 56 | 70 | 70 | |
| † 51-717-007 | — | 2* | 250 | 125 | 200 | 125 | 15 | 0.015 | 0.005 | LB | 0.325 | (8.255) | A | — | — | — | 6 | 25 | 38 | 45 | |
| † 51-359-007 | — | 1 | 250 | 125 | 200 | 125 | 15 | 0.012 | 0.005 | LB | 0.370 | (9.398) | A | — | — | — | 6 | 25 | 38 | 50 | |
| 9050-100-0011 | — | 2 | 350 | 125 | 300 | 125 | 15 | 0.150 | 0.008 | LB | 0.325 | (8.255) | A | — | 10 | 15 | 25 | 40 | 52 | 60 | |
| € SCI-2350-000 | — | 1 | 300 | 125 | 300 | 125 | 15 | 0.250 | 0.003 | LB | 0.450 | (11.430) | A | 4 | 15 | 21 | 31 | 50 | 70 | 70 | |
| SCI-2350-001 | — | 1 | 300 | 125 | 300 | 125 | 15 | 0.250 | 0.003 | LB | 0.450 | (11.430) | B | 4 | 15 | 21 | 31 | 50 | 70 | 70 | |

* Part is resin sealed, this is not a hermetic part.

(See MIL index on pages CF9-11 for complete MIL part number listing)

.375 ø L Circuit MIL Qualified Low Profile

| Part Number | M15733 M28861 MIL No | See Pg. LP28 for Fig | Rated Voltage | | | | I Amp | Min Cap µF | DCR Max Ohms | CKT | Max L | | Thd Lgth | Minimum Insertion Loss (dB) | | | | | | | |
|--------------|----------------------|----------------------|---------------|----|-------|-----|-------|------------|--------------|-----|-------|----------|----------|-----------------------------|---------|---------|-------|--------|---------|-------|--|
| | | | 85°C | | 125°C | | | | | | In | (mm) | | 30 KHz | 150 KHz | 300 KHz | 1 MHz | 10 MHz | 100 MHz | 1 GHz | |
| | | | DC | AC | DC | AC | | | | | | | | | | | | | | | |
| † 51-359-021 | 38-0004 | 1 | — | — | 50 | — | 10 | 1.400 | 0.008 | LB | 0.370 | (9.398) | A | 15 | 28 | 33 | 44 | 60 | 70 | 70 | |
| † 51-359-024 | 38-0005 | 1 | 80 | — | 50 | — | 10 | 1.400 | 0.008 | LB | 0.370 | (9.398) | A | 15 | 28 | 33 | 44 | 60 | 70 | 70 | |
| † 51-359-051 | 58-0001 | 1 | 80 | — | 50 | — | 10 | 1.400 | 0.008 | LB | 0.545 | (13.843) | A | 15 | 28 | 33 | 44 | 60 | 70 | 70 | |
| 51-359-105 | 58-0004 | 1 | 80 | — | 50 | — | 10 | 1.400 | 0.008 | LT | 0.545 | (13.843) | B | 15 | 28 | 33 | 44 | 60 | 70 | 70 | |
| † 51-359-044 | 49-0006 | 1 | 100 | — | 50 | — | 15 | 1.200 | 0.010 | LB | 0.370 | (9.398) | A | 15 | 28 | 33 | 44 | 60 | 70 | 70 | |
| † 51-359-055 | 49-0007 | 3 | 100 | — | 50 | — | 15 | 1.200 | 0.010 | LB | 0.450 | (11.43) | A | 15 | 28 | 33 | 44 | 60 | 70 | 70 | |
| 51-359-081 | 1-001◇ | 1 | — | — | 50 | — | 15 | 1.400 | 0.008 | LB | 0.410 | (10.414) | A | 15 | 28 | 33 | 40 | 40 | 70 | 70 | |
| 51-359-086 | 1-011◇ | 1 | — | — | 50 | — | 15 | 1.400 | 0.008 | LB | 0.410 | (10.414) | B | 15 | 28 | 33 | 40 | 40 | 70 | 70 | |
| † 51-359-053 | 49-0001 | 4 | 100 | — | 50 | — | 15 | 0.680 | 0.010 | LB | 0.319 | (8.103) | A | 8 | 20 | 28 | 38 | 55 | 70 | 70 | |
| 51-359-082 | 1-003◇ | 1 | — | — | 70 | — | 15 | 0.700 | 0.008 | LB | 0.410 | (10.414) | A | 10 | 24 | 30 | 40 | 40 | 64 | 70 | |
| 51-359-083 | 1-005◇ | 1 | — | — | 100 | — | 15 | 0.450 | 0.008 | LB | 0.410 | (10.414) | A | 6 | 19 | 25 | 36 | 40 | 60 | 70 | |
| 51-359-088 | 1-015◇ | 1 | — | — | 100 | — | 15 | 0.450 | 0.008 | LB | 0.410 | (10.414) | B | 6 | 19 | 25 | 36 | 40 | 60 | 70 | |
| 51-359-084 | 1-007◇ | 1 | — | — | 150 | — | 15 | 0.250 | 0.008 | LB | 0.410 | (10.414) | A | — | 14 | 20 | 31 | 40 | 56 | 70 | |
| 51-359-050 | 38-0008 | 1 | — | — | 200 | 125 | 15 | 0.150 | 0.008 | LB | 0.370 | (9.398) | A | — | — | — | 6 | 25 | 42 | 60 | |
| 51-359-085 | 1-009◇ | 1 | — | — | 200 | 125 | 15 | 0.150 | 0.008 | LB | 0.410 | (10.414) | A | — | 10 | 16 | 26 | 40 | 52 | 70 | |
| 51-359-090 | 1-019◇ | 1 | — | — | 200 | 125 | 15 | 0.150 | 0.008 | LB | 0.410 | (10.414) | B | — | 10 | 16 | 26 | 40 | 52 | 70 | |

† Also available through authorized distributors.

€ Also available through authorized European distributors/agents.

Hermetically Sealed Threaded Case Filters

.375 ø L Circuit

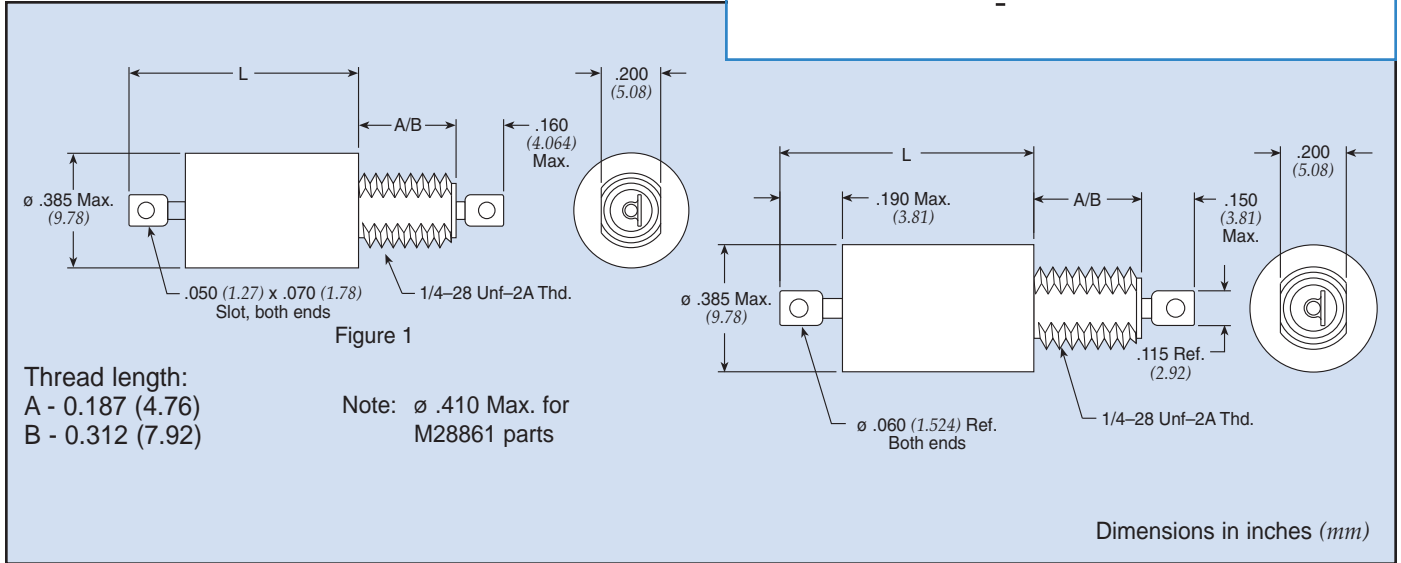

.375 ø L Circuit Standard Product

| Part Number | MIL No | Figure | Rated Voltage | | | | I Amp | Min Cap µF | DCR Max Ohms | CKT | Max L In | Max L (mm) | Thd Lgth | Minimum Insertion Loss (dB) | | | | | | |
|-----------------|--------|--------|---------------|---------|----------|----------|-------|------------|--------------|-----|----------|------------|----------|-----------------------------|---------|---------|-------|--------|---------|-------|
| | | | 85°C DC | 85°C AC | 125°C DC | 125°C AC | | | | | | | | 30 KHz | 150 KHz | 300 KHz | 1 MHz | 10 MHz | 100 MHz | 1 GHz |
| 51-353-007 | — | 1 | 80 | — | 50 | — | 0.06 | 1.400 | 70.000 | LB | 0.770 | (19.558) | A | 44 | 70 | 70 | 70 | 70 | 70 | 70 |
| 51-353-095 | — | 1 | 80 | — | 50 | — | 0.15 | 1.400 | 12.000 | LT | 0.960 | (24.384) | A | 21 | 52 | 64 | 70 | 70 | 70 | 70 |
| 51-353-003 | — | 1 | 80 | — | 50 | — | 0.45 | 1.400 | 1.200 | LB | 0.770 | (19.558) | A | 16 | 31 | 37 | 55 | 70 | 70 | 70 |
| 51-353-099 | — | 1 | 80 | — | 50 | — | 1.00 | 1.400 | 0.250 | LT | 0.770 | (19.558) | A | 16 | 33 | 44 | 70 | 70 | 70 | 70 |
| 51-353-100 | — | 1 | 80 | — | 50 | — | 5.00 | 1.400 | 0.015 | LT | 0.770 | (19.558) | A | 15 | 28 | 33 | 46 | 70 | 70 | 70 |
| † 9200-300-0025 | — | 1 | 80 | — | 50 | — | 10.00 | 1.200 | 0.010 | LB | 0.450 | (11.430) | A | 15 | 28 | 33 | 44 | 60 | 70 | 70 |

† Also available through authorized distributors.

Hermetically Sealed Threaded Case Filters

L-C Filter LT

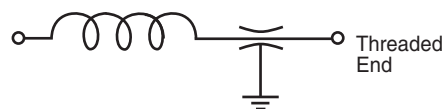

L-C Filter LB

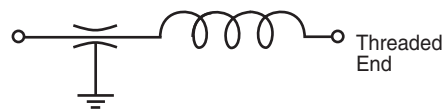

.375 ø L Circuit Standard Product *continued*

| Part Number | MIL No | See Pg. LP30 for Fig | Rated Voltage | | | | I Amp | Min Cap µF | DCR Max Ohms | CKT | Max L | | Thd Lgth | Minimum Insertion Loss (dB) | | | | | | |
|-----------------|--------|----------------------|---------------|----|-------|-----|-------|------------|--------------|-----|-------|----------|----------|-----------------------------|---------|---------|-------|--------|---------|-------|
| | | | 85°C | | 125°C | | | | | | In | (mm) | | 30 KHz | 150 KHz | 300 KHz | 1 MHz | 10 MHz | 100 MHz | 1 GHz |
| | | | DC | AC | DC | AC | | | | | | | | | | | | | | |
| † 9200-303-0095 | — | 1 | 80 | — | 50 | — | 10.00 | 1.200 | 0.010 | LB | 0.450 | (11.430) | B | 15 | 28 | 33 | 44 | 60 | 70 | 70 |
| 51-353-101 | — | 1 | 80 | — | 50 | — | 10.00 | 1.400 | 0.010 | LT | 0.450 | (11.430) | A | 14 | 28 | 33 | 44 | 60 | 70 | 70 |
| 51-353-109 | — | 1 | 80 | — | 50 | — | 10.00 | 1.400 | 0.010 | LT | 0.450 | (11.430) | B | 15 | 28 | 33 | 44 | 60 | 70 | 70 |
| 51-353-120 | — | 1 | 150 | — | 100 | — | 1.00 | 0.750 | 0.250 | LB | 0.758 | (19.253) | A | 9 | 27 | 36 | 57 | 70 | 70 | 70 |
| 9000-103-0019 | — | 1 | 150 | — | 100 | — | 5.00 | 0.450 | 0.015 | LT | 0.758 | (19.253) | B | 6 | 20 | 26 | 37 | 68 | 70 | 70 |
| SCI-2120-014 | — | 1 | 150 | — | 100 | — | 10.00 | 1.000 | 0.003 | LB | 0.450 | (11.430) | B | 14 | 28 | 34 | 44 | 52 | 70 | 70 |
| 51-353-110 | — | 1 | 250 | — | 200 | 125 | 1.00 | 0.250 | 0.250 | LT | 0.758 | (19.253) | A | — | 17 | 29 | 50 | 70 | 70 | 70 |
| † 51-353-111 | — | 1 | 250 | — | 200 | 125 | 1.00 | 0.250 | 0.250 | LB | 0.758 | (19.253) | A | — | 17 | 29 | 50 | 70 | 70 | 70 |
| 51-353-112 | — | 1 | 250 | — | 200 | 125 | 3.00 | 0.250 | 0.050 | LT | 0.758 | (19.253) | A | — | 13 | 20 | 35 | 70 | 70 | 70 |
| † 51-353-113 | — | 1 | 250 | — | 200 | 125 | 3.00 | 0.250 | 0.050 | LB | 0.758 | (19.253) | A | — | 13 | 20 | 35 | 70 | 70 | 70 |
| 51-353-114 | — | 1 | 250 | — | 200 | 125 | 5.00 | 0.250 | 0.015 | LT | 0.758 | (19.253) | A | — | 12 | 20 | 30 | 62 | 70 | 70 |
| 51-353-116 | — | 1 | 250 | — | 200 | 125 | 10.00 | 0.250 | 0.010 | LT | 0.450 | (11.430) | A | — | 15 | 20 | 30 | 50 | 70 | 70 |
| SCI-2320-010 | — | 1 | 300 | — | 300 | 125 | 0.50 | 0.150 | 1.000 | LB | 0.758 | (19.253) | B | — | 23 | 35 | 56 | 70 | 70 | 70 |
| SCI-2320-004 | — | 1 | 300 | — | 300 | 125 | 1.00 | 0.150 | 0.250 | LB | 0.758 | (19.253) | A | — | 10 | 21 | 41 | 70 | 70 | 70 |
| SCI-2320-005 | — | 1 | 300 | — | 300 | 125 | 2.00 | 0.150 | 0.063 | LB | 0.758 | (19.253) | A | — | 8 | 14 | 30 | 70 | 70 | 70 |
| SCI-2320-006 | — | 1 | 300 | — | 300 | 125 | 3.00 | 0.150 | 0.027 | LB | 0.758 | (19.253) | A | — | 8 | 14 | 26 | 64 | 70 | 70 |
| SCI-2320-007 | — | 1 | 300 | — | 300 | 125 | 10.00 | 0.150 | 0.003 | LB | 0.450 | (11.430) | A | — | 8 | 14 | 25 | 45 | 52 | 70 |
| SCI-2320-014 | — | 1 | 300 | — | 300 | 125 | 10.00 | 0.150 | 0.003 | LB | 0.450 | (11.430) | B | — | 8 | 14 | 25 | 45 | 52 | 70 |

(See MIL index on pages CF9-11 for complete MIL part number listing)

.375 ø L Circuit MIL Qualified Profile

| Part Number | M15733 MIL No | See Pg. LP30 for Fig | Rated Voltage | | | | I Amp | Min Cap µF | DCR Max Ohms | CKT | Max L | | Thd Lgth | Minimum Insertion Loss (dB) | | | | | | |
|--------------|---------------|----------------------|---------------|----|-------|----|-------|------------|--------------|-----|-------|----------|----------|-----------------------------|---------|---------|-------|--------|---------|-------|
| | | | 85°C | | 125°C | | | | | | In | (mm) | | 30 KHz | 150 KHz | 300 KHz | 1 MHz | 10 MHz | 100 MHz | 1 GHz |
| | | | DC | AC | DC | AC | | | | | | | | | | | | | | |
| 51-390-018 | 23-0026 | 1 | — | — | 50 | — | 0.50 | 1.400 | 0.360 | LB | 0.630 | (16.002) | A | 12 | 36 | 48 | 69 | 70 | 70 | 70 |
| 51-390-026 | 23-0038 | 1 | — | — | 50 | — | 1.00 | 1.400 | 0.140 | LB | 0.630 | (16.002) | A | 11 | 26 | 36 | 55 | 70 | 70 | 70 |
| 51-390-034 | 23-0050 | 1 | — | — | 50 | — | 2.00 | 1.400 | 0.070 | LB | 0.630 | (16.002) | A | 10 | 24 | 32 | 48 | 70 | 70 | 70 |
| † 51-353-067 | 24-0006 | 1 | 80 | — | 50 | — | 10.00 | 1.400 | 0.010 | LB | 0.760 | (19.304) | B | 15 | 28 | 31 | 42 | 56 | 70 | 70 |
| 51-353-207 | 34-0007 | 1 | — | — | 50 | — | 10.00 | 1.400 | 0.010 | LB | 0.760 | (19.304) | A | 15 | 28 | 31 | 42 | 56 | 70 | 70 |
| 51-444-072 | 58-0002 | 1 | 80 | — | 50 | — | 10.00 | 1.400 | 0.008 | LT | 0.545 | (13.843) | A | 15 | 28 | 33 | 44 | 60 | 70 | 70 |
| † 51-353-066 | 24-0005 | 1 | 80 | — | 50 | — | 10.00 | 1.400 | 0.010 | LB | 0.760 | (19.304) | A | 15 | 28 | 31 | 42 | 56 | 70 | 70 |
| 51-353-287 | 39-0014 | 1 | — | — | 50 | — | 10.00 | 1.400 | 0.003 | LT | 0.760 | (19.304) | B | 14 | 28 | 34 | 44 | 52 | 70 | 70 |
| † 51-444-060 | 24-0008 | 1 | 80 | — | 50 | — | 10.00 | 1.400 | 0.010 | LT | 0.740 | (18.796) | B | 15 | 28 | 31 | 42 | 56 | 70 | 70 |
| † 51-343-028 | 38-0002 | 1 | — | — | 50 | — | 15.00 | 1.400 | 0.008 | LB | 0.481 | (12.217) | A | 15 | 28 | 33 | 44 | 64 | 70 | 70 |
| † 51-343-034 | 38-0006 | 1 | — | — | 50 | — | 15.00 | 1.400 | 0.008 | LB | 0.481 | (12.217) | B | 15 | 28 | 33 | 44 | 64 | 70 | 70 |
| 51-353-053 | 25-0003 | 1 | — | — | 100 | — | 1.00 | 0.450 | 0.250 | LB | 0.738 | (18.745) | A | 6 | 23 | 34 | 55 | 70 | 70 | 70 |
| † 51-353-054 | 25-0005 | 1 | — | — | 100 | — | 5.00 | 0.450 | 0.015 | LT | 0.758 | (19.253) | A | 6 | 17 | 23 | 35 | 69 | 70 | 70 |
| † 51-353-055 | 25-0008 | 1 | — | — | 100 | — | 5.00 | 0.450 | 0.015 | LB | 0.738 | (18.745) | A | 6 | 17 | 23 | 35 | 69 | 70 | 70 |
| 51-353-155 | 39-0008 | 1 | — | — | 100 | — | 5.00 | 0.450 | 0.015 | LB | 0.760 | (19.304) | A | 6 | 20 | 26 | 35 | 60 | 60 | 70 |
| 51-444-039 | 25-0017 | 1 | — | — | 100 | — | 5.00 | 0.450 | 0.015 | LT | 0.758 | (19.253) | B | 6 | 17 | 23 | 35 | 69 | 70 | 70 |

† Also available through authorized distributors.

Hermetically Sealed Threaded Case Filters

L-C Filter LT

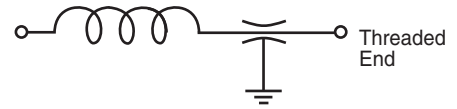

L-C Filter LB

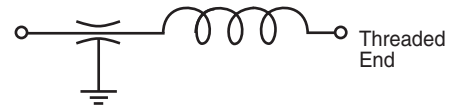

.375 ø L Circuit MIL Qualified Profile *continued*

(See MIL index on pages CF9-11 for complete MIL part number listing)

| Part Number | M15733 MIL No | See Pg. LP30 for Fig | Rated Voltage | | | | I Amp | Min Cap µF | DCR Max Ohms | CKT | Max L In | Max L (mm) | Thd Lgth | Minimum Insertion Loss (dB) | | | | | | | |
|--------------|---------------|----------------------|---------------|----|-------|-----|-------|------------|--------------|-----|----------------|------------|----------|-----------------------------|---------|---------|-------|--------|---------|-------|--|
| | | | 85°C | | 125°C | | | | | | | | | 30 KHz | 150 KHz | 300 KHz | 1 MHz | 10 MHz | 100 MHz | 1 GHz | |
| | | | DC | AC | DC | AC | | | | | | | | | | | | | | | |
| 51-444-040 | 25-0020 | 1 | — | — | 100 | | 5.00 | 0.450 | 0.015 | LB | 0.738 (18.745) | B | 6 | 17 | 23 | 35 | 69 | 70 | 70 | | |
| 51-353-156 | 39-0009 | 1 | — | — | 100 | | 10.00 | 0.450 | 0.003 | LT | 0.760 (19.304) | A | 6 | 20 | 26 | 35 | 56 | 60 | 70 | | |
| 51-353-157 | 39-0010 | 1 | — | — | 100 | | 10.00 | 0.450 | 0.003 | LB | 0.760 (19.304) | A | 6 | 20 | 26 | 35 | 56 | 60 | 70 | | |
| + 51-353-076 | 26-0001 | 1 | — | — | 150 | 125 | 1.00 | 0.250 | 0.250 | LT | 0.758 (19.253) | A | — | 13 | 24 | 45 | 80 | 70 | 70 | | |
| + 51-353-077 | 26-0003 | 1 | — | — | 150 | 125 | 1.00 | 0.250 | 0.250 | LB | 0.738 (18.745) | A | — | 13 | 24 | 45 | 80 | 70 | 70 | | |
| 51-444-043 | 26-0013 | 1 | — | — | 150 | 125 | 1.00 | 0.250 | 0.250 | LT | 0.758 (19.253) | B | — | 13 | 24 | 45 | 80 | 70 | 70 | | |
| 51-444-044 | 26-0015 | 1 | — | — | 150 | 125 | 1.00 | 0.250 | 0.250 | LB | 0.738 (18.745) | B | — | 13 | 24 | 45 | 80 | 70 | 70 | | |
| 51-390-040 | 23-0058 | 1 | — | — | 150 | | 2.00 | 0.250 | 0.070 | LT | 0.630 (16.002) | A | 3 | 15 | 23 | 38 | 60 | 70 | 60 | | |
| 51-390-039 | 23-0057 | 1 | — | — | 150 | | 2.00 | 0.250 | 0.070 | LT | 0.630 (16.002) | B | 3 | 15 | 23 | 38 | 60 | 70 | 60 | | |
| 51-444-005 | 34-0015 | 1 | — | — | 150 | 125 | 3.00 | 0.150 | 0.050 | LT | 0.758 (19.253) | B | — | 8 | 15 | 30 | 68 | 70 | 70 | | |
| + 51-353-078 | 26-0004 | 1 | — | — | 150 | 125 | 3.00 | 0.250 | 0.050 | LT | 0.758 (19.253) | A | — | 8 | 15 | 30 | 68 | 70 | 70 | | |
| + 51-353-079 | 26-0006 | 1 | — | — | 150 | 125 | 3.00 | 0.250 | 0.050 | LB | 0.738 (18.745) | A | — | 8 | 15 | 30 | 68 | 70 | 70 | | |
| + 51-444-046 | 26-0018 | 1 | — | — | 150 | 125 | 3.00 | 0.250 | 0.050 | LB | 0.738 (18.745) | B | — | 8 | 15 | 30 | 68 | 70 | 70 | | |
| 51-444-047 | 26-0019 | 1 | — | — | 150 | 125 | 5.00 | 0.250 | 0.015 | LT | 0.758 (19.253) | B | — | 8 | 14 | 25 | 58 | 70 | 70 | | |
| + 51-353-080 | 26-0007 | 1 | — | — | 150 | 125 | 5.00 | 0.250 | 0.015 | LT | 0.758 (19.253) | A | — | 8 | 14 | 25 | 58 | 70 | 70 | | |
| 51-353-081 | 26-0010 | 1 | — | — | 150 | 125 | 5.00 | 0.250 | 0.015 | LB | 0.738 (18.745) | A | — | 8 | 14 | 25 | 58 | 70 | 70 | | |
| 51-444-027 | 34-0030 | 1 | — | — | 200 | 125 | 5.00 | 0.250 | 0.150 | LB | 0.900 (22.860) | A | 2 | 15 | 21 | 32 | 60 | 70 | 70 | | |
| 51-444-117 | 54-0018 | 2 | — | — | 300 | 125 | 1.00 | 0.150 | 0.250 | LB | 0.740 (18.796) | A | — | 10 | 21 | 41 | 70 | 70 | 70 | | |

† Also available through authorized distributors.

Hermetically Sealed Threaded Case Filters



.375 ϕ Pi Circuit

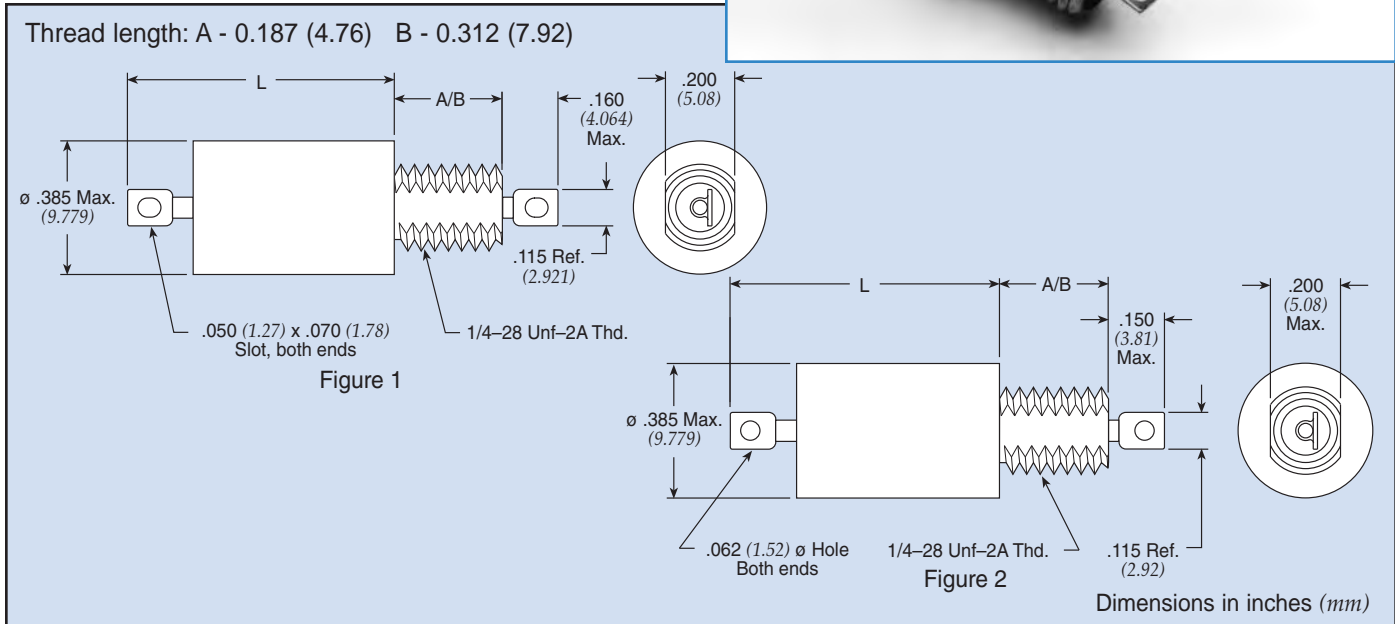

.375 ϕ Pi Circuit Standard Product

| Part Number | MIL No | Figure | Rated Voltage | | | | I Amp | Min Cap μ F | DCR Max Ohms | Max L | | Thd Lgth | Minimum Insertion Loss (dB) | | | | | | |
|----------------|--------|--------|---------------|-----|-------|-----|-------|-----------------|--------------|-------|----------|----------|-----------------------------|---------|---------|-------|--------|---------|-------|
| | | | 85°C | | 125°C | | | | | In | (mm) | | 30 KHz | 150 KHz | 300 KHz | 1 MHz | 10 MHz | 100 MHz | 1 GHz |
| SCI-2030-010 | — | 2 | 80 | — | 50 | — | 0.50 | 1.500 | 1.000 | 0.758 | (19.253) | B | 24 | 66 | 70 | 70 | 70 | 70 | |
| SCI-2030-004 | — | 2 | 80 | — | 50 | — | 1.00 | 1.500 | 0.250 | 0.758 | (19.253) | A | 15 | 54 | 70 | 70 | 70 | 70 | |
| SCI-2030-005 | — | 2 | 80 | — | 50 | — | 2.00 | 1.500 | 0.063 | 0.758 | (19.253) | A | — | 45 | 62 | 70 | 70 | 70 | |
| SCI-2030-006 | — | 2 | 80 | — | 50 | — | 3.00 | 1.500 | 0.027 | 0.758 | (19.253) | A | — | 35 | 55 | 70 | 70 | 70 | |
| SCI-2030-013 | — | 2 | 80 | — | 50 | — | 3.00 | 1.500 | 0.027 | 0.758 | (19.253) | B | — | 35 | 55 | 70 | 70 | 70 | |
| †9001-100-1080 | — | 1 | 80 | — | 50 | — | 5.00 | 2.800 | 0.015 | 0.758 | (19.253) | A | — | 18 | 60 | 70 | 70 | 70 | |
| †9001-100-1081 | — | 1 | 80 | — | 50 | — | 10.0 | 2.800 | 0.005 | 0.758 | (19.253) | A | 21 | 32 | 40 | 35 | 68 | 70 | 70 |
| SCI-2130-009 | — | 1 | 150 | — | 100 | — | 0.25 | 1.000 | 4.000 | 0.758 | (19.253) | B | 28 | 70 | 70 | 70 | 70 | 70 | 70 |
| 51-311-319 | — | 1 | 150 | — | 100 | — | 0.50 | 1.000 | 0.600 | 0.758 | (19.253) | A | — | 51 | 69 | 70 | 70 | 70 | 70 |
| †9001-100-1010 | — | 1 | 150 | — | 100 | — | 0.50 | 1.000 | 0.600 | 0.758 | (19.253) | A | 6 | 39 | 68 | 70 | 70 | 70 | 70 |
| 51-311-320 | — | 1 | 150 | — | 100 | — | 1.00 | 1.000 | 0.250 | 0.758 | (19.253) | A | — | 41 | 60 | 70 | 70 | 70 | 70 |
| †9001-100-1013 | — | 1 | 150 | — | 100 | — | 1.00 | 1.000 | 0.250 | 0.758 | (19.253) | A | — | 28 | 59 | 70 | 70 | 70 | 70 |
| 51-311-321 | — | 1 | 150 | — | 100 | — | 3.00 | 1.000 | 0.060 | 0.758 | (19.253) | A | — | 16 | 41 | 70 | 70 | 70 | 70 |
| †51-311-322 | — | 1 | 150 | — | 100 | — | 5.00 | 1.000 | 0.015 | 0.758 | (19.253) | A | — | — | 28 | 65 | 70 | 70 | 70 |
| SCI-2130-007 | — | 1 | 150 | — | 100 | — | 10.0 | 1.000 | 0.003 | 0.758 | (19.253) | A | 9 | 24 | 29 | 40 | 70 | 70 | 70 |
| SCI-2130-014 | — | 1 | 150 | — | 100 | — | 10.0 | 1.000 | 0.005 | 0.758 | (19.253) | B | 9 | 24 | 29 | 40 | 70 | 70 | 70 |
| 51-311-316 | — | 1 | 250 | 125 | 200 | 125 | 1.00 | 0.300 | 0.250 | 0.758 | (19.253) | A | — | 20 | 40 | 70 | 70 | 70 | 70 |
| 51-311-317 | — | 1 | 250 | 125 | 200 | 125 | 3.00 | 0.300 | 0.050 | 0.758 | (19.253) | A | — | — | 20 | 55 | 70 | 70 | 70 |
| †9001-100-1025 | — | 1 | 250 | 125 | 200 | 125 | 5.00 | 0.300 | 0.015 | 0.758 | (19.253) | A | — | — | 12 | 50 | 70 | 70 | 80 |
| SCI-2330-009 | — | 1 | 300 | 125 | 300 | 125 | 0.25 | 0.300 | 4.000 | 0.758 | (19.253) | B | 8 | 50 | 66 | 70 | 70 | 70 | 70 |
| SCI-2330-010 | — | 1 | 300 | 125 | 300 | 125 | 0.50 | 0.300 | 1.000 | 0.758 | (19.253) | B | — | 40 | 56 | 70 | 70 | 70 | 70 |
| SCI-2330-012 | — | 1 | 300 | 125 | 300 | 125 | 2.00 | 0.300 | 0.063 | 0.758 | (19.253) | B | — | 18 | 33 | 63 | 70 | 70 | 70 |
| SCI-2330-007 | — | 1 | 300 | 125 | 300 | 125 | 10.0 | 0.300 | 0.003 | 0.758 | (19.253) | A | — | 14 | 20 | 30 | 70 | 70 | 70 |

† Also available through authorized distributors.

Hermetically Sealed Threaded Case Filters

.375 ø Pi Circuit MIL Qualified Product

(See MIL index on pages CF9-11 for complete MIL part number listing)

| Part Number | M15733 MIL No | See Pg. LP33 for Fig. | Rated Voltage | | | | I Amp | Min Cap µF | DCR Max Ohms | Max L | | Thd Lgth | Minimum Insertion Loss (dB) | | | | | | |
|--------------|---------------|-----------------------|---------------|----|-------|-----|-------|------------|--------------|-------|----------|----------|-----------------------------|---------|---------|-------|--------|---------|-------|
| | | | 85°C | | 125°C | | | | | In | (mm) | | 30 KHz | 150 KHz | 300 KHz | 1 MHz | 10 MHz | 100 MHz | 1 GHz |
| | | | DC | AC | DC | AC | | | | | | | | | | | | | |
| 51-390-305 | 23-0017 | 1 | — | — | 50 | — | 0.30 | 2.800 | 0.770 | 0.730 | (18.542) | B | 29 | 73 | 80 | 80 | 80 | 80 | |
| 51-390-314 | 23-0042 | 1 | — | — | 50 | — | 1.00 | 2.800 | 0.140 | 0.730 | (18.542) | A | 8 | 52 | 71 | 80 | 80 | 80 | 80 |
| † 51-390-318 | 23-0054 | 1 | — | — | 50 | — | 2.00 | 1.500 | 0.070 | 0.730 | (18.542) | A | — | 46 | 65 | 80 | 80 | 80 | 80 |
| † 51-390-317 | 23-0053 | 1 | — | — | 50 | — | 2.00 | 1.500 | 0.070 | 0.730 | (18.542) | B | — | 46 | 65 | 80 | 80 | 80 | 80 |
| 51-311-311 | 25-0010 | 1 | — | — | 100 | — | 0.25 | 0.900 | 1.500 | 0.793 | (20.142) | A | — | 48 | 66 | 80 | 80 | 80 | 70 |
| † 51-311-308 | 25-0002 | 1 | — | — | 100 | — | 1.00 | 0.500 | 0.250 | 0.793 | (20.142) | A | — | 33 | 52 | 80 | 80 | 80 | 70 |
| † 51-311-309 | 25-0004 | 1 | — | — | 100 | — | 3.00 | 0.660 | 0.050 | 0.793 | (20.142) | A | — | 17 | 34 | 68 | 80 | 80 | 70 |
| † 51-311-310 | 25-0006 | 1 | — | — | 100 | — | 5.00 | 0.900 | 0.015 | 0.793 | (20.142) | A | — | — | 17 | 57 | 80 | 80 | 70 |
| 51-353-344 | 39-0011 | 1 | — | — | 100 | — | 10.0 | 0.990 | 0.003 | 0.760 | (19.304) | A | 9 | 24 | 29 | 40 | 70 | 70 | 70 |
| 51-353-345 | 39-0012 | 1 | — | — | 100 | — | 10.0 | 0.990 | 0.003 | 0.760 | (19.304) | A | 9 | 24 | 29 | 40 | 70 | 70 | 70 |
| † 51-311-314 | 26-0011 | 1 | — | — | 150 | 125 | 0.25 | 0.300 | 1.500 | 0.793 | (20.142) | A | — | 29 | 47 | 70 | 80 | 80 | 70 |
| 51-390-312 | 23-0036 | 1 | — | — | 150 | — | 0.50 | 0.500 | 0.360 | 0.730 | (18.542) | A | — | 48 | 66 | 70 | 70 | 70 | 70 |
| 51-390-311 | 23-0035 | 1 | — | — | 150 | — | 0.50 | 0.500 | 0.360 | 0.730 | (18.542) | B | — | 48 | 66 | 70 | 70 | 70 | 70 |
| † 51-353-336 | 26-0002 | 1 | — | — | 150 | 125 | 1.00 | 0.300 | 0.250 | 0.793 | (20.142) | A | — | 11 | 32 | 63 | 80 | 80 | 70 |
| 51-390-315 | 23-0047 | 1 | — | — | 150 | — | 1.00 | 0.500 | 0.140 | 0.730 | (18.542) | B | — | 32 | 51 | 70 | 70 | 70 | 70 |
| 51-311-312 | 26-0005 | 1 | — | — | 150 | 125 | 3.00 | 0.300 | 0.050 | 0.793 | (20.142) | A | — | 5 | 6 | 47 | 80 | 80 | 70 |
| 51-311-408 | 54-0005 | 2 | — | — | 300 | 115 | 1.00 | 0.300 | 0.250 | 0.761 | (19.329) | A | — | 23 | 43 | 70 | 70 | 70 | 70 |

† Also available through authorized distributors.

Transient Suppression Pi Filters

| Part Number | See Pg. LP33 for Fig. | Rated Volt. VDC | I Amp | Min Cap µF | DCR Min Mohms | Max RDC Ohms | Transient Suppressor* | | | | Length | | Max Thd Lgth | Minimum Insertion Loss (dB) | | | | | | |
|-------------|-----------------------|-----------------|-------|------------|---------------|--------------|-----------------------|-----------|----------|----------|--------|----------|--------------|-----------------------------|---------|-------|--------|---------|-------|--|
| | | | | | | | VR* (VDC) | BV* (VDC) | IT* (MA) | IPP* (A) | In | (mm) | | 30 KHz | 300 KHz | 1 MHz | 10 MHz | 100 MHz | 1 GHz | |
| | | | | | | | | | | | | | | | | | | | | |
| 51-570-300 | 1 | 5 | 0.50 | 1.400 | 0.500 | 0.600 | 6.5 | 7.22/7.98 | 10 | 44.7 | 1.179 | (29.947) | A | 23 | 57 | 70 | 70 | 70 | 70 | |
| 51-570-301 | 1 | 5 | 1.00 | 1.400 | 0.500 | 0.350 | 6.5 | 7.22/7.98 | 10 | 44.7 | 1.179 | (29.947) | A | 3 | 47 | 70 | 70 | 70 | 70 | |
| 51-570-302 | 1 | 5 | 3.00 | 1.400 | 0.500 | 0.060 | 6.5 | 7.22/7.98 | 10 | 44.7 | 1.179 | (29.947) | A | — | 23 | 58 | 70 | 70 | 70 | |
| 51-570-303 | 1 | 5 | 5.00 | 1.400 | 0.500 | 0.015 | 6.5 | 7.22/7.98 | 10 | 44.7 | 1.179 | (29.947) | A | — | 17 | 48 | 70 | 70 | 70 | |
| 51-570-304 | 1 | 5 | 10.00 | 1.400 | 0.500 | 0.005 | 6.5 | 7.22/7.98 | 10 | 44.7 | 1.179 | (29.947) | A | 16 | 26 | 35 | 40 | 60 | 70 | |
| 51-570-310 | 1 | 28 | 0.50 | 1.400 | 30.000 | 0.600 | 33.0 | 36.7/40.6 | 1 | 9.4 | 1.179 | (29.947) | A | 23 | 57 | 70 | 70 | 70 | 70 | |
| 51-570-311 | 1 | 28 | 1.00 | 1.400 | 30.000 | 0.350 | 33.0 | 36.7/40.6 | 1 | 9.4 | 1.179 | (29.947) | A | 3 | 47 | 70 | 70 | 70 | 70 | |
| 51-570-312 | 1 | 28 | 3.00 | 1.400 | 30.000 | 0.060 | 33.0 | 36.7/40.6 | 1 | 9.4 | 1.179 | (29.947) | A | — | 23 | 58 | 70 | 70 | 70 | |
| 51-570-313 | 1 | 28 | 5.00 | 1.400 | 30.000 | 0.015 | 33.0 | 36.7/40.6 | 1 | 9.4 | 1.179 | (29.947) | A | — | 17 | 48 | 70 | 70 | 70 | |
| 51-570-314 | 1 | 28 | 10.00 | 1.400 | 30.000 | 0.005 | 33.0 | 36.7/40.6 | 1 | 9.4 | 1.179 | (29.947) | A | 16 | 26 | 35 | 40 | 60 | 70 | |
| 51-570-320 | 1 | 50 | 0.50 | 1.400 | 50.000 | 0.600 | 58.0 | 64.4/71.2 | 1 | 5.3 | 1.179 | (29.947) | A | 23 | 57 | 70 | 70 | 70 | 70 | |
| 51-570-321 | 1 | 50 | 1.00 | 1.400 | 50.000 | 0.350 | 58.0 | 64.4/71.2 | 1 | 5.3 | 1.179 | (29.947) | A | 3 | 47 | 70 | 70 | 70 | 70 | |
| 51-570-322 | 1 | 50 | 3.00 | 1.400 | 50.000 | 0.060 | 58.0 | 64.4/71.2 | 1 | 5.3 | 1.179 | (29.947) | A | — | 23 | 58 | 70 | 70 | 70 | |
| 51-570-323 | 1 | 50 | 5.00 | 1.400 | 50.000 | 0.015 | 58.0 | 64.4/71.2 | 1 | 5.3 | 1.179 | (29.947) | A | — | 17 | 48 | 70 | 70 | 70 | |
| 51-570-324 | 1 | 50 | 10.00 | 1.400 | 50.000 | 0.005 | 58.0 | 64.4/71.2 | 1 | 5.3 | 1.179 | (29.947) | A | 16 | 26 | 35 | 40 | 60 | 70 | |

* Transient Suppression definitions and ratings

VR = Reverse standoff voltage
BV = Breakdown voltage

IPP = Max. peak pulse current
IT = Test current

Hermetically Sealed Threaded Case Filters



.375 ø T Circuit

Thread length: A - 0.187 (4.76) B - 0.312 (7.92)

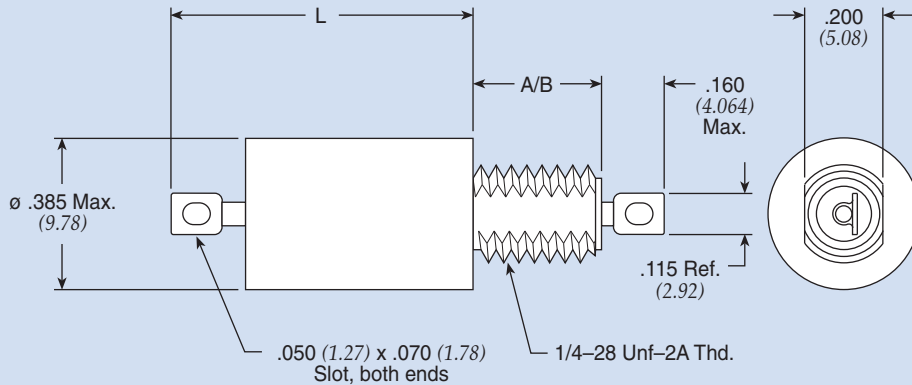

Figure 1

Note: Max. O.D. is ø .416" for Military QPL Filters.

Dimensions in inches (mm)

.375 ø T Circuit Standard Product

| Part Number | MIL No | Figure | Rated Voltage | | | | I Amp | Min Cap µF | DCR Max Ohms | Max L In (mm) | Thd Lgth | Minimum Insertion Loss (dB) | | | | | | |
|----------------|--------|--------|---------------|---|-------|-----|-------|------------|--------------|----------------|----------|-----------------------------|---------|---------|-------|--------|---------|-------|
| | | | 85°C | | 125°C | | | | | | | 30 KHz | 150 KHz | 300 KHz | 1 MHz | 10 MHz | 100 MHz | 1 GHz |
| SCI-2040-012 | — | 1 | 80 | — | 50 | — | 2.00 | 1.400 | 0.126 | 1.071 (27.203) | B | 8 | 22 | 30 | 55 | 70 | 70 | 70 |
| SCI-2040-013 | — | 1 | 80 | — | 50 | — | 3.00 | 1.400 | 0.054 | 1.071 (27.203) | B | 8 | 22 | 28 | 43 | 70 | 70 | 70 |
| +9004-100-2017 | — | 1 | 80 | — | 50 | — | 15.0 | 1.400 | 0.005 | 1.179 (29.947) | A | 17 | 27 | 34 | 44 | 60 | 70 | 70 |
| SCI-2140-004 | — | 1 | 150 | — | 100 | — | 1.00 | 0.500 | 0.500 | 1.070 (27.178) | A | 4 | 25 | 40 | 70 | 70 | 70 | 70 |
| SCI-2140-006 | — | 1 | 150 | — | 100 | — | 3.00 | 0.500 | 0.054 | 1.071 (27.203) | A | 4 | 19 | 24 | 39 | 70 | 70 | 70 |
| SCI-2140-007 | — | 1 | 150 | — | 100 | — | 10.0 | 0.500 | 0.010 | 1.071 (27.203) | A | 4 | 19 | 24 | 34 | 57 | 70 | 70 |
| SCI-2340-009 | — | 1 | 300 | — | 300 | 125 | 0.25 | 0.150 | 8.000 | 1.071 (27.203) | B | 11 | 57 | 70 | 70 | 70 | 70 | 70 |
| SCI-2340-004 | — | 1 | 300 | — | 300 | 125 | 1.00 | 0.150 | 0.500 | 1.071 (27.203) | A | — | 13 | 29 | 59 | 70 | 70 | 70 |
| SCI-2340-013 | — | 1 | 300 | — | 300 | 125 | 3.00 | 0.150 | 0.054 | 1.071 (27.203) | B | — | 8 | 14 | 29 | 70 | 70 | 70 |
| SCI-2340-014 | — | 1 | 300 | — | 300 | 125 | 10.0 | 0.150 | 0.010 | 1.071 (27.203) | B | — | 8 | 14 | 24 | 47 | 70 | 70 |

+ Also available through authorized distributors.

(See MIL index on pages CF9-11 for complete MIL part number listing)

.375 ø T Circuit MIL Qualified Product

| Part Number | M15733 MIL No | Figure | Rated Voltage | | | | I Amp | Min Cap µF | DCR Max Ohms | Max L In (mm) | Thd Lgth | Minimum Insertion Loss (dB) | | | | | | |
|-------------|---------------|--------|---------------|---|-------|-----|-------|------------|--------------|----------------|----------|-----------------------------|---------|---------|-------|--------|---------|-------|
| | | | 85°C | | 125°C | | | | | | | 30 KHz | 150 KHz | 300 KHz | 1 MHz | 10 MHz | 100 MHz | 1 GHz |
| 51-382-609 | 25-0024 | 1 | — | — | 100 | — | 2.00 | 0.750 | 0.100 | 1.179 (29.947) | B | 10 | 22 | 31 | 55 | 80 | 70 | 70 |
| 51-382-603 | 25-0007 | 1 | — | — | 100 | — | 4.00 | 0.750 | 0.063 | 1.345 (34.163) | A | 10 | 22 | 28 | 43 | 80 | 70 | 70 |
| +51-351-604 | 26-0012 | 1 | — | — | 150 | 125 | 2.00 | 0.250 | 0.100 | 1.179 (29.947) | A | — | 13 | 21 | 43 | 80 | 70 | 70 |
| 51-351-603 | 26-0008 | 1 | — | — | 150 | 125 | 4.00 | 0.250 | 0.063 | 1.345 (34.163) | A | — | 11 | 18 | 33 | 80 | 70 | 70 |

+ Also available through authorized distributors.

Hermetically Sealed Threaded Case Filters

.375 ø TT Circuit Standard Product

| Part Number | MIL No | See Pg. LP35 for Fig. | Rated Voltage | | | | I Amp | Min Cap μ F | DCR Max Ohms | Max L | | Thd Lgth | Minimum Insertion Loss (dB) | | | | | | |
|--------------|--------|-----------------------|---------------|----|-------|-----|-------|-----------------|--------------|-------|----------|----------|-----------------------------|---------|---------|-------|--------|---------|-------|
| | | | 85°C | | 125°C | | | | | In | (mm) | | 30 KHz | 150 KHz | 300 KHz | 1 MHz | 10 MHz | 100 MHz | 1 GHz |
| | | | DC | AC | DC | AC | | | | | | | | | | | | | |
| SCI-2060-009 | — | 1 | — | — | 50 | — | 0.25 | 1.500 | 12.000 | 1.241 | (31.521) | B | 70 | 70 | 70 | 70 | 70 | 70 | 70 |
| SCI-2060-013 | — | 1 | — | — | 50 | — | 3.00 | 1.500 | 0.081 | 1.241 | (31.521) | B | — | 33 | 54 | 70 | 70 | 70 | 70 |
| SCI-2060-007 | — | 1 | — | — | 50 | — | 10.0 | 1.500 | 0.006 | 1.241 | (31.521) | A | 15 | 29 | 35 | 42 | 55 | 70 | 70 |
| SCI-2060-014 | — | 1 | — | — | 50 | — | 10.0 | 1.500 | 0.006 | 1.241 | (31.521) | B | 15 | 29 | 35 | 42 | 55 | 70 | 70 |
| SCI-2160-011 | — | 1 | — | — | 100 | — | 1.00 | 1.500 | 0.750 | 1.241 | (31.521) | B | 12 | 52 | 70 | 70 | 70 | 70 | 70 |
| SCI-2160-012 | — | 1 | — | — | 100 | — | 2.00 | 1.500 | 0.189 | 1.241 | (31.521) | B | — | 33 | 56 | 70 | 70 | 70 | 70 |
| SCI-2160-013 | — | 1 | — | — | 100 | — | 3.00 | 1.500 | 0.081 | 1.241 | (31.521) | B | — | 24 | 54 | 70 | 70 | 70 | 70 |
| SCI-2160-014 | — | 1 | — | — | 100 | — | 10.0 | 1.400 | 0.006 | 1.241 | (31.521) | B | 12 | 25 | 32 | 42 | 70 | 70 | 70 |
| SCI-2360-011 | — | 1 | — | — | 300 | 125 | 1.00 | 0.500 | 0.750 | 1.241 | (31.521) | B | — | 48 | 70 | 70 | 70 | 70 | 70 |
| SCI-2360-006 | — | 1 | — | — | 300 | 125 | 3.00 | 0.500 | 0.080 | 1.241 | (31.521) | A | — | 12 | 38 | 70 | 70 | 70 | 70 |
| SCI-2360-007 | — | 1 | — | — | 300 | 125 | 10.0 | 0.500 | 0.006 | 1.241 | (31.521) | A | 5 | 18 | 24 | 34 | 55 | 70 | 70 |
| SCI-2360-014 | — | 1 | — | — | 300 | 125 | 10.0 | 0.500 | 0.006 | 1.241 | (31.521) | B | 5 | 18 | 24 | 34 | 55 | 70 | 70 |

Hermetically Sealed Threaded Case Filters

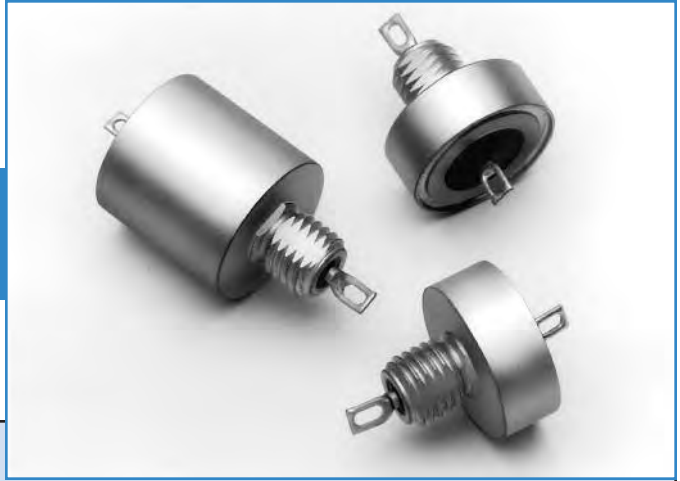

.690 ø C Circuit

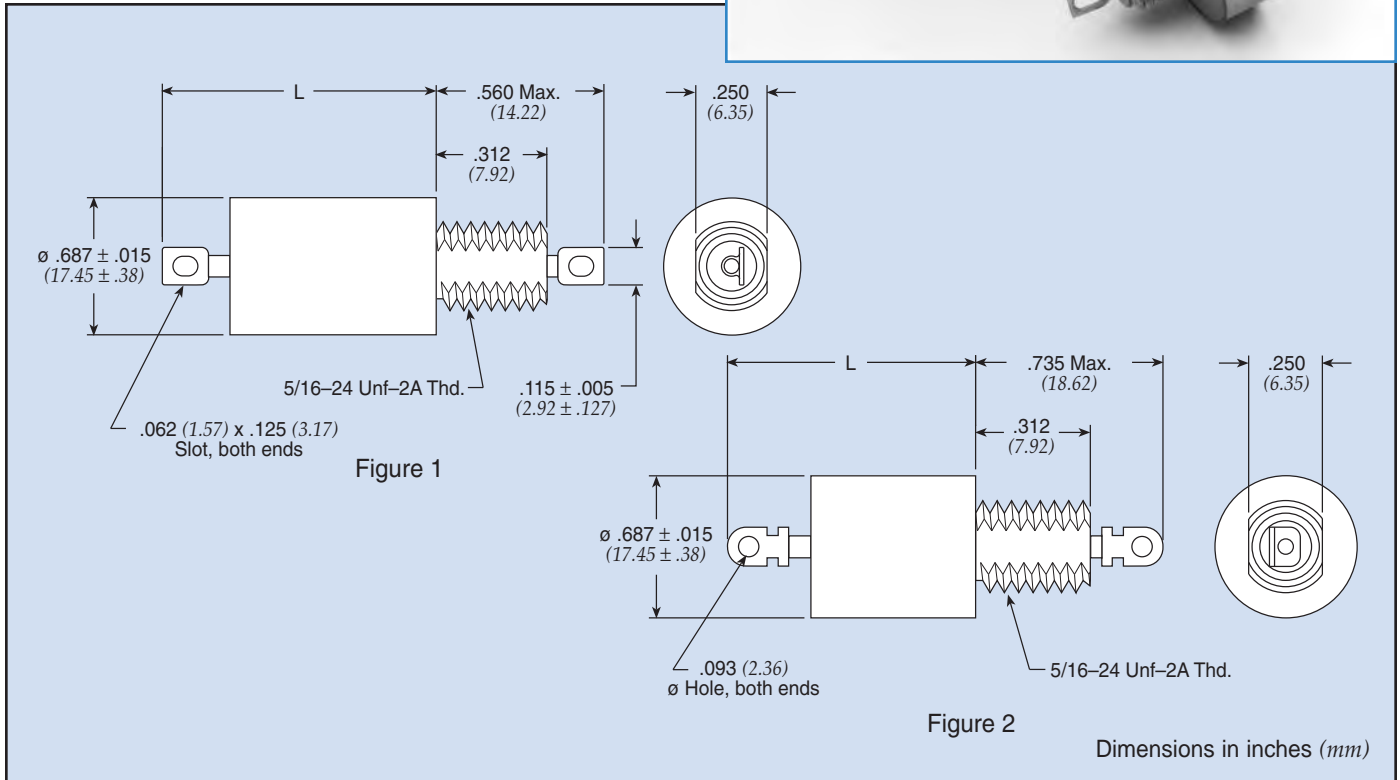

.690 ø C Circuit Standard Product

| Part Number | MIL No | Figure | Rated Voltage | | | | I Amp | Min Cap μF | DCR Max Ohms | Max L | | Minimum Insertion Loss (dB) | | | | | | |
|-----------------|--------|--------|---------------|-----|-------|-----|-------|-----------------------|--------------|-------|----------|-----------------------------|---------|---------|-------|--------|---------|-------|
| | | | 85°C | | 125°C | | | | | In | L (mm) | 30 KHz | 150 KHz | 300 KHz | 1 MHz | 10 MHz | 100 MHz | 1 GHz |
| | | | DC | AC | DC | AC | | | | | | | | | | | | |
| † 9932-100-6004 | — | 1 | 200 | — | 150 | 125 | 15 | 2.600 | 0.005 | 0.702 | (17.831) | 10 | 29 | 39 | 50 | 60 | 70 | 70 |
| 54-310-001 | — | 1 | 300 | — | 300 | 125 | 15 | 0.500 | 0.005 | 0.560 | (14.224) | 6 | 19 | 25 | 36 | 50 | 70 | 70 |
| 54-310-005 | — | 2 | 250 | — | 200 | 125 | 25 | 0.500 | 0.005 | 0.750 | (19.050) | 6 | 19 | 25 | 36 | 50 | 70 | 70 |
| 54-310-009 | — | 1 | 450 | 240 | 400 | 240 | 15 | 0.250 | 0.005 | 0.560 | (14.224) | — | 14 | 19 | 30 | 45 | 60 | 70 |
| † 9932-100-6005 | — | 1 | 450 | 240 | 400 | 240 | 15 | 0.250 | 0.005 | 0.560 | (14.224) | — | 14 | 19 | 30 | 50 | 70 | 70 |

.690 ø C Circuit MIL Qualified Product

| Part Number | M15733 MIL No | Figure | Rated Voltage | | | | I Amp | Min Cap μF | DCR Max Ohms | Max L | | Minimum Insertion Loss (dB) | | | | | | |
|-------------|---------------|--------|---------------|----|-------|-----|-------|-----------------------|--------------|-------|----------|-----------------------------|---------|---------|-------|--------|---------|-------|
| | | | 85°C | | 125°C | | | | | In | L (mm) | 30 KHz | 150 KHz | 300 KHz | 1 MHz | 10 MHz | 100 MHz | 1 GHz |
| | | | DC | AC | DC | AC | | | | | | | | | | | | |
| 54-310-039 | 34-0037 | 1 | — | — | 275 | 125 | 15 | 0.200 | 0.005 | 0.575 | (14.605) | 5 | 15 | 21 | 31 | 51 | 70 | 70 |

.690 ø C Circuit DSCC 84084 Product

| Part Number | 84084 No | Figure | Rated Voltage | | | | I Amp | Min Cap μF | DCR Max Ohms | Max L | | Minimum Insertion Loss (dB) | | | | | | |
|-------------|----------|--------|---------------|----|-------|-----|-------|-----------------------|--------------|-------|----------|-----------------------------|---------|---------|-------|--------|---------|-------|
| | | | 85°C | | 125°C | | | | | In | L (mm) | 30 KHz | 150 KHz | 300 KHz | 1 MHz | 10 MHz | 100 MHz | 1 GHz |
| | | | DC | AC | DC | AC | | | | | | | | | | | | |
| 54-310-042 | -001 | 1 | — | — | 400 | 230 | 15 | 0.150 | 0.005 | 0.700 | (17.780) | — | 10 | 16 | 26 | 40 | 52 | 70 |

† Also available through authorized distributors.

Hermetically Sealed Threaded Case Filters



.690 ø L Circuit

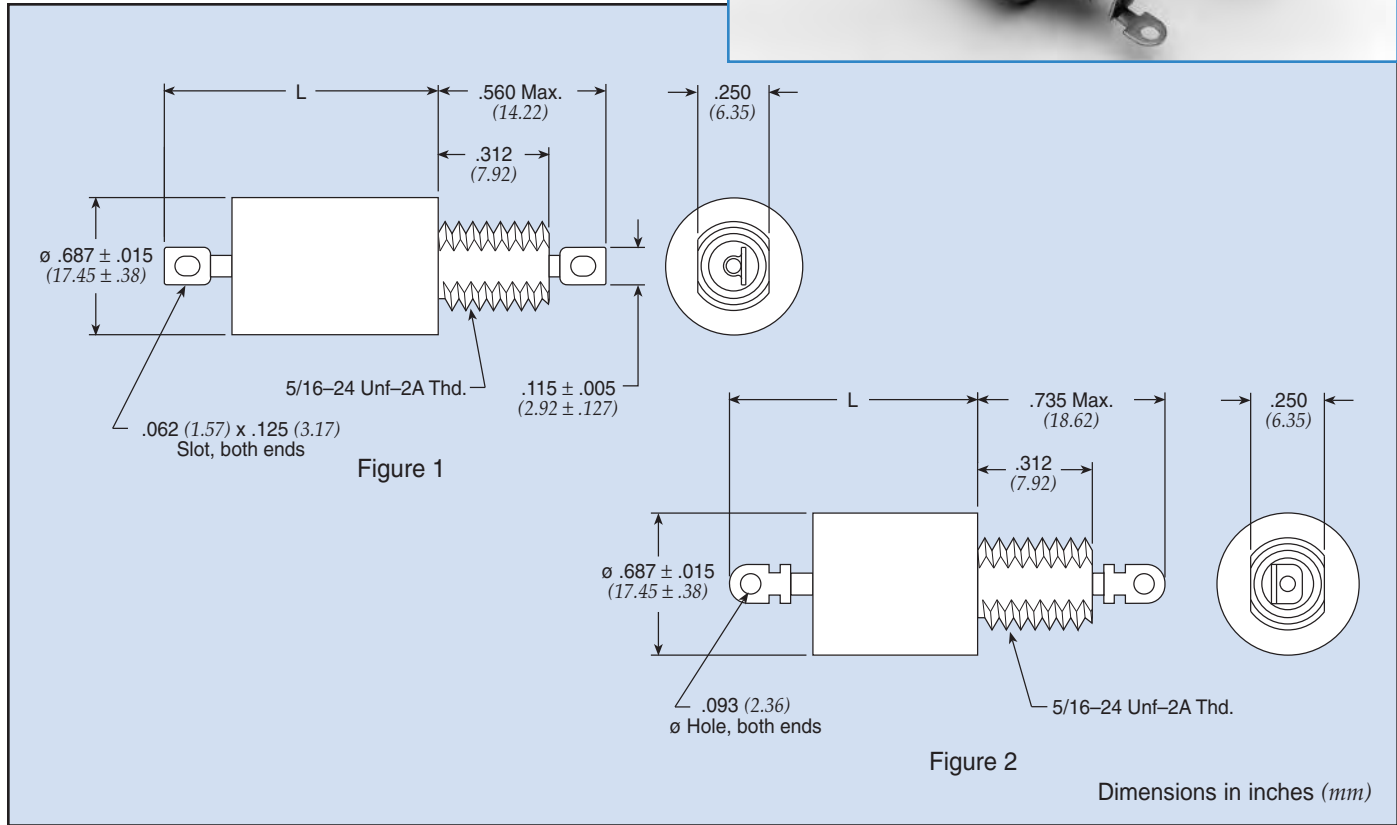

.690 ø L Circuit Standard Product

| Part Number | MIL No | Figure | Rated Voltage | | | | I Amp | Min Cap µF | DCR Max Ohms | CKT | Max L | | Minimum Insertion Loss (dB) | | | | | | |
|---------------|--------|--------|---------------|-----|-------|-----|-------|------------|--------------|-----|-------|----------|-----------------------------|---------|---------|-------|--------|---------|-------|
| | | | 85°C | | 125°C | | | | | | In | L (mm) | 30 KHz | 150 KHz | 300 KHz | 1 MHz | 10 MHz | 100 MHz | 1 GHz |
| 9010-100-0049 | — | 1 | 150 | — | 100 | — | 10.0 | 1.400 | 0.005 | LT | 0.905 | (22.987) | 16 | 24 | 34 | 44 | 60 | 70 | 70 |
| SCI-6120-008 | — | 1 | 150 | — | 100 | — | 10.0 | 2.600 | 0.006 | LB | 0.959 | (24.359) | 18 | 32 | 39 | 49 | 70 | 70 | 70 |
| SCI-6120-009 | — | 1 | 150 | — | 100 | — | 20.0 | 2.600 | 0.001 | LB | 0.560 | (22.987) | 18 | 32 | 39 | 49 | 60 | 70 | 70 |
| 51-320-041 | — | 1 | 250 | — | 200 | 125 | 10.0 | 0.500 | 0.008 | LT | 0.905 | (22.987) | 5 | 19 | 25 | 35 | 50 | 70 | 70 |
| 51-320-024 | — | 1 | 450 | 240 | 400 | 240 | 1.00 | 0.360 | 0.210 | LT | 0.905 | (22.987) | 5 | 30 | 38 | 60 | 70 | 70 | 70 |
| 51-320-100 | — | 1 | 450 | 240 | 400 | 240 | 1.00 | 0.250 | 0.210 | LT | 0.905 | (22.987) | — | 21 | 33 | 55 | 70 | 70 | 70 |
| † 51-320-026 | — | 1 | 450 | 240 | 400 | 240 | 3.00 | 0.360 | 0.030 | LT | 0.905 | (22.987) | 5 | 19 | 25 | 45 | 70 | 70 | 70 |
| 51-320-103 | — | 1 | 450 | 240 | 400 | 240 | 5.00 | 0.360 | 0.010 | LB | 0.905 | (22.987) | — | 12 | 18 | 30 | 60 | 70 | 70 |
| 51-322-007 | — | 1 | 450 | 240 | 400 | 240 | 15.0 | 0.360 | 0.007 | LB | 0.650 | (16.510) | 5 | 19 | 25 | 35 | 48 | 62 | 70 |
| 51-322-015 | — | 2 | 450 | 240 | 400 | 240 | 25.0 | 0.360 | 0.007 | LT | 0.750 | (19.050) | 5 | 17 | 23 | 34 | 48 | 62 | 70 |
| 51-322-036 | — | 2 | 450 | 240 | 400 | 240 | 25.0 | 0.250 | 0.007 | LB | 0.750 | (19.050) | — | 10 | 16 | 29 | 45 | 60 | 70 |
| 9010-100-0054 | — | 1 | 450 | 240 | 300 | 240 | 1.00 | 0.150 | 0.250 | LT | 0.905 | (22.987) | — | 14 | 32 | 52 | 70 | 70 | 70 |
| SCI-6320-004 | — | 1 | 300 | — | 300 | 125 | 1.00 | 0.400 | 0.300 | LB | 0.959 | (24.359) | 6 | 24 | 35 | 56 | 70 | 70 | 70 |

† Also available through authorized distributors.

Hermetically Sealed Threaded Case Filters

L-C Filter LT

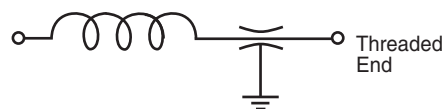

L-C Filter LB



(See MIL index on pages CF9-11 for complete MIL part number listing)

.690 ø L Circuit MIL Qualified Product

| Part Number | M15733 MIL No | See Pg. LP38 for Fig. | Rated Voltage | | | | I Amp | Min Cap μ F | DCR Max Ohms | CKT | Max L In | Max L (mm) | Minimum Insertion Loss (dB) | | | | | | |
|--------------|---------------|-----------------------|---------------|----|-------|-----|-------|-----------------|--------------|-----|----------|------------|-----------------------------|---------|---------|-------|--------|---------|-------|
| | | | 85°C | | 125°C | | | | | | | | 30 KHz | 150 KHz | 300 KHz | 1 MHz | 10 MHz | 100 MHz | 1 GHz |
| | | | DC | AC | DC | AC | | | | | | | | | | | | | |
| † 51-320-015 | 27-0005 | 1 | — | — | 200 | 125 | 3.00 | 0.250 | 0.033 | LT | 0.900 | (22.860) | — | 14 | 21 | 39 | 80 | 70 | 70 |
| 51-320-017 | 27-0008 | 1 | — | — | 200 | 125 | 5.00 | 0.250 | 0.016 | LT | 0.900 | (22.860) | — | 13 | 19 | 32 | 69 | 70 | 70 |
| 51-320-018 | 27-0009 | 1 | — | — | 200 | 125 | 5.00 | 0.250 | 0.016 | LB | 0.900 | (22.860) | — | 13 | 19 | 32 | 69 | 70 | 70 |
| 51-323-003 | 27-0011 | 1 | — | — | 200 | 125 | 10.0 | 0.250 | 0.005 | LT | 1.031 | (26.187) | — | 13 | 19 | 30 | 61 | 70 | 70 |
| 51-323-004 | 27-0012 | 1 | — | — | 200 | 125 | 10.0 | 0.250 | 0.005 | LB | 1.031 | (26.187) | — | 13 | 19 | 30 | 61 | 70 | 70 |
| † 51-322-009 | 27-0014 | 2 | — | — | 200 | 125 | 15.0 | 0.250 | 0.007 | LT | 1.763 | (44.780) | — | 19 | 25 | 36 | 60 | 70 | 70 |
| 51-322-017 | 34-0002 | 2 | — | — | 200 | 125 | 20.0 | 0.360 | 0.050 | LB | 1.763 | (44.780) | — | 19 | 25 | 35 | 57 | 70 | 70 |

.690 ø L Circuit DSCC 84084 Product

| Part Number | 84084 No | See Pg. LP38 for Fig. | Rated Voltage | | | | I Amp | Min Cap μ F | DCR Max Ohms | CKT | Max L In | Max L (mm) | Minimum Insertion Loss (dB) | | | | | | |
|-------------|----------|-----------------------|---------------|----|-------|-----|-------|-----------------|--------------|-----|----------|------------|-----------------------------|---------|---------|-------|--------|---------|-------|
| | | | 85°C | | 125°C | | | | | | | | 30 KHz | 150 KHz | 300 KHz | 1 MHz | 10 MHz | 100 MHz | 1 GHz |
| | | | DC | AC | DC | AC | | | | | | | | | | | | | |
| 51-320-162 | -004 | 1 | — | — | 400 | 230 | 1.00 | 0.150 | 0.150 | LT | 0.905 | (22.987) | — | 19 | 30 | 46 | 60 | 70 | 70 |
| 51-320-163 | -005 | 1 | — | — | 400 | 230 | 1.00 | 0.150 | 0.150 | LB | 0.905 | (22.987) | — | 19 | 30 | 46 | 60 | 70 | 70 |
| 51-320-164 | -006 | 1 | — | — | 400 | 230 | 3.00 | 0.150 | 0.026 | LT | 0.905 | (22.987) | — | 11 | 19 | 36 | 60 | 70 | 70 |
| 51-320-165 | -007 | 1 | — | — | 400 | 230 | 3.00 | 0.150 | 0.026 | LB | 0.905 | (22.987) | — | 11 | 19 | 36 | 60 | 70 | 70 |
| 51-320-166 | -008 | 1 | — | — | 400 | 230 | 5.00 | 0.150 | 0.013 | LT | 0.905 | (22.987) | — | 10 | 16 | 28 | 54 | 70 | 70 |
| 51-320-167 | -009 | 1 | — | — | 400 | 230 | 5.00 | 0.150 | 0.013 | LB | 0.905 | (22.987) | — | 10 | 16 | 28 | 54 | 70 | 70 |
| 51-320-168 | -010 | 1 | — | — | 400 | 230 | 10.0 | 0.150 | 0.008 | LT | 0.905 | (22.987) | — | 10 | 16 | 25 | 48 | 70 | 70 |
| 51-320-169 | -011 | 1 | — | — | 400 | 230 | 10.0 | 0.150 | 0.008 | LB | 0.905 | (22.987) | — | 10 | 16 | 25 | 48 | 70 | 70 |

† Also available through authorized distributors.

Hermetically Sealed Threaded Case Filters

.690 ø Pi Circuit

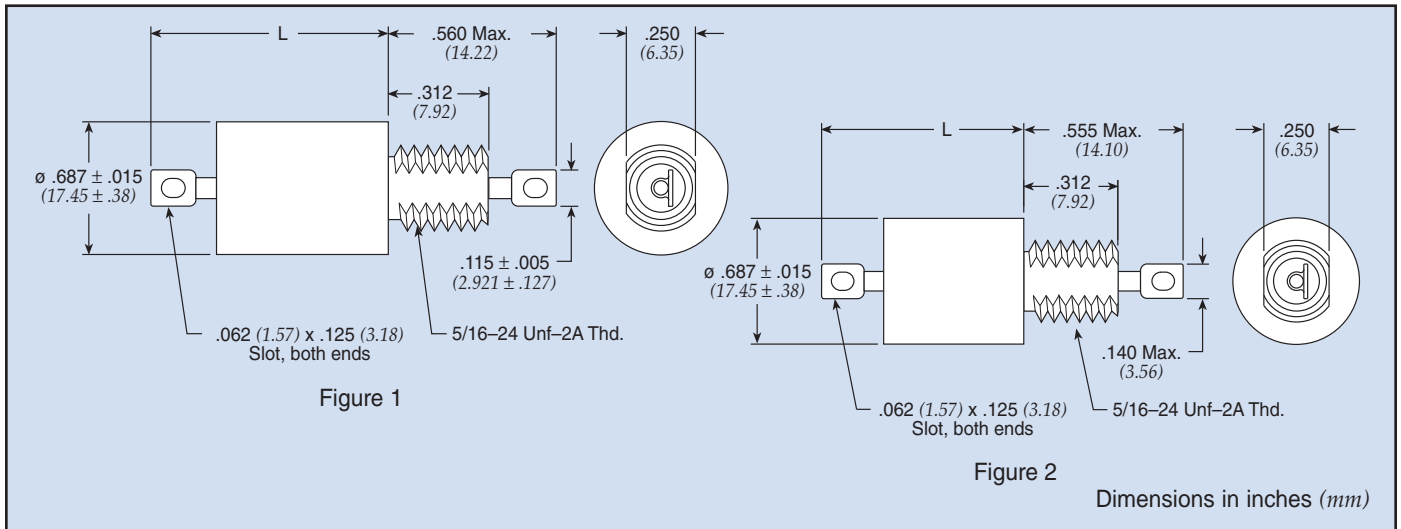

.690 ø Pi Circuit Standard Product

| Part Number | MIL No | Figure | Rated Voltage | | | | I Amp | Min Cap μ F | DCR Max Ohms | Max L | | Minimum Insertion Loss (dB) | | | | | | |
|--------------|--------|--------|---------------|-----|-------|------|-------|-----------------|--------------|-------|----------|-----------------------------|---------|---------|-------|--------|---------|-------|
| | | | 85°C | | 125°C | | | | | In | L (mm) | 30 KHz | 150 KHz | 300 KHz | 1 MHz | 10 MHz | 100 MHz | 1 GHz |
| | | | DC | AC | DC | AC | | | | | | | | | | | | |
| 51-321-322 | — | 1 | 150 | — | 100 | — | 1.00 | 2.800 | 0.210 | 1.195 | (30.353) | 35 | 69 | 70 | 70 | 70 | 70 | 70 |
| SCI-6130-009 | — | 1 | 150 | — | 100 | — | 20.0 | 5.200 | 0.001 | 1.195 | (30.353) | 23 | 31 | 35 | 35 | 70 | 70 | 70 |
| 51-321-317 | — | 1 | 450 | 240 | 400 | *240 | 1.00 | 0.720 | 0.400 | 1.195 | (30.353) | — | 53 | 70 | 70 | 70 | 70 | 70 |
| †51-321-318 | — | 1 | 450 | 240 | 400 | *240 | 3.00 | 0.720 | 0.030 | 1.195 | (30.353) | — | 31 | 51 | 70 | 70 | 70 | 70 |
| †51-321-319 | — | 1 | 450 | 240 | 400 | *240 | 5.00 | 0.720 | 0.020 | 1.195 | (30.353) | — | 11 | 30 | 65 | 70 | 70 | 70 |

* 0-60 Hz

.690 ø Pi Circuit MIL Qualified Product

(See MIL index on pages CF8-10 for complete MIL part number listing)

| Part Number | M15733 MIL No | Figure | Rated Voltage | | | | I Amp | Min Cap μ F | DCR Max Ohms | Max L | | Minimum Insertion Loss (dB) | | | | | | |
|-------------|---------------|--------|---------------|----|-------|-----|-------|-----------------|--------------|-------|----------|-----------------------------|---------|---------|-------|--------|---------|-------|
| | | | 85°C | | 125°C | | | | | In | L (mm) | 30 KHz | 150 KHz | 300 KHz | 1 MHz | 10 MHz | 100 MHz | 1 GHz |
| | | | DC | AC | DC | AC | | | | | | | | | | | | |
| 51-321-312 | 27-0004 | 1 | — | — | 200 | 125 | 1.00 | 0.500 | 0.250 | 1.195 | (30.353) | — | 47 | 65 | 80 | 80 | 70 | 70 |
| 51-323-313 | 27-0003 | 1 | — | — | 200 | 125 | 1.00 | 0.500 | 0.270 | 1.031 | (26.187) | — | 43 | 61 | 80 | 80 | 70 | 70 |
| 51-321-313 | 27-0010 | 1 | — | — | 200 | 125 | 5.00 | 0.500 | 0.024 | 1.195 | (30.353) | — | 10 | 28 | 64 | 80 | 70 | 70 |
| †51-321-314 | 27-0013 | 1 | — | — | 200 | 125 | 10.0 | 0.500 | 0.008 | 1.195 | (30.353) | — | 16 | 18 | 48 | 80 | 70 | 70 |
| 51-321-329 | 34-0005 | 1 | — | — | 200 | 125 | 10.0 | 0.500 | 0.075 | 1.195 | (30.353) | — | 16 | 18 | 48 | 80 | 70 | 70 |

.690 ø Pi Circuit DSCC 84084 Product

| Part Number | 84084 No | Figure | Rated Voltage | | | | I Amp | Min Cap μ F | DCR Max Ohms | Max L | | Minimum Insertion Loss (dB) | | | | | | |
|-------------|----------|--------|---------------|----|-------|-----|-------|-----------------|--------------|-------|----------|-----------------------------|---------|---------|-------|--------|---------|-------|
| | | | 85°C | | 125°C | | | | | In | L (mm) | 30 KHz | 150 KHz | 300 KHz | 1 MHz | 10 MHz | 100 MHz | 1 GHz |
| | | | DC | AC | DC | AC | | | | | | | | | | | | |
| 51-321-398 | -013 | 2 | — | — | 400 | 230 | 1.00 | 0.200 | 0.150 | 1.200 | (30.480) | — | 27 | 46 | 74 | 80 | 80 | 80 |
| 51-321-399 | -014 | 2 | — | — | 400 | 230 | 3.00 | 0.200 | 0.026 | 1.200 | (30.480) | — | — | 30 | 60 | 80 | 80 | 80 |
| 51-321-400 | -015 | 2 | — | — | 400 | 230 | 5.00 | 0.200 | 0.013 | 1.200 | (30.480) | — | — | 12 | 50 | 80 | 80 | 80 |
| 51-321-401 | -016 | 2 | — | — | 400 | 230 | 10.0 | 0.200 | 0.008 | 1.200 | (30.480) | — | — | — | 30 | 80 | 80 | 80 |

† Also available through authorized distributors.

Hermetically Sealed Threaded Case Filters

.690 ø T Circuit

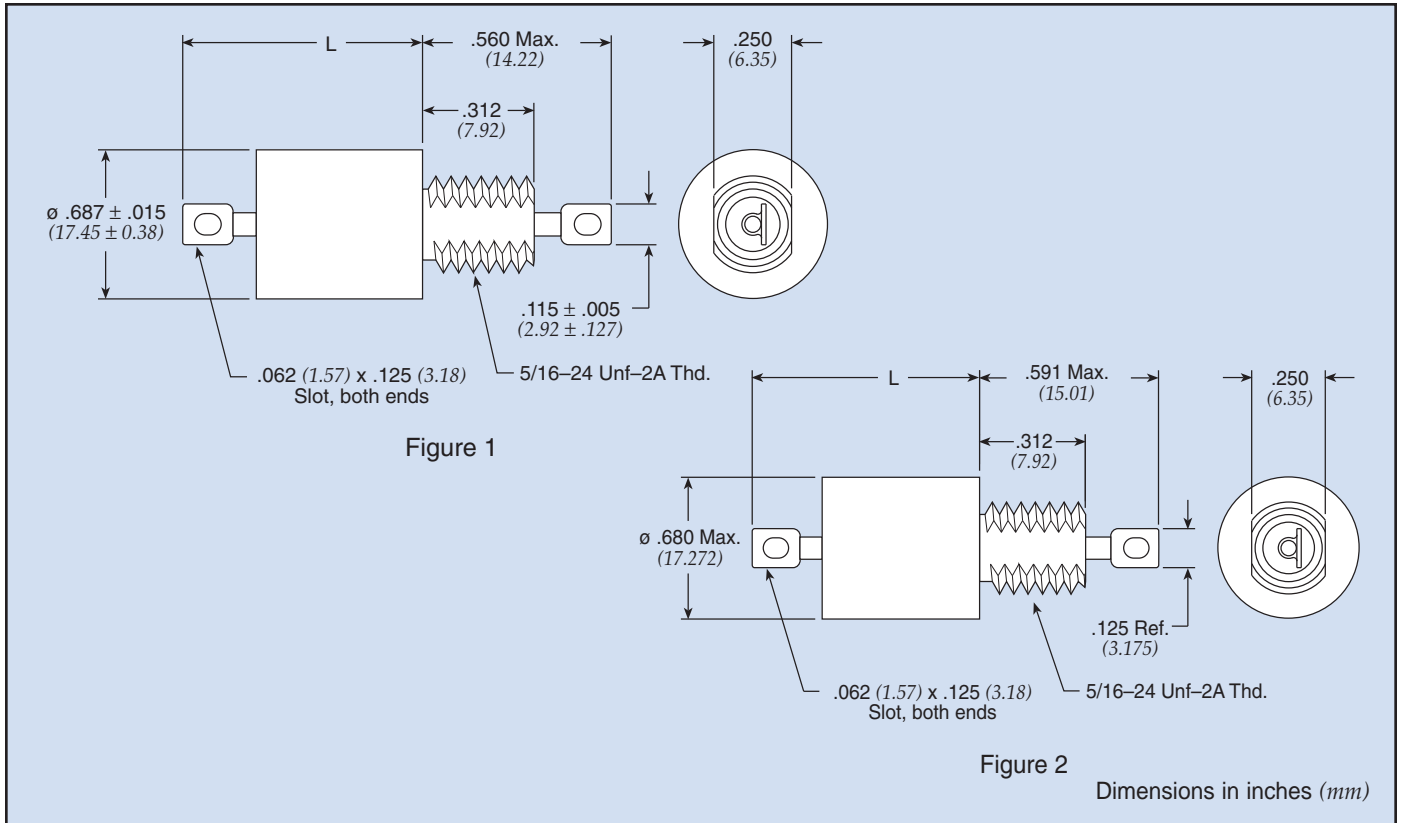

.690 ø T Circuit Standard Product

| Part Number | MIL No | Figure | Rated Voltage | | | | I Amp | Min Cap μ F | DCR Max Ohms | Max L (mm) | | Minimum Insertion Loss (dB) | | | | | | |
|--------------|--------|--------|---------------|-----|-------|-----|-------|-----------------|--------------|------------|----------|-----------------------------|---------|---------|-------|--------|---------|-------|
| | | | 85°C | | 125°C | | | | | | | 30 KHz | 150 KHz | 300 KHz | 1 MHz | 10 MHz | 100 MHz | 1 GHz |
| | | | DC | AC | DC | AC | | | | | | In | L | | | | | |
| SCI-6140-004 | — | 1 | 150 | — | 100 | — | 1.00 | 2.600 | 0.600 | 1.195 | (30.353) | 23 | 54 | 70 | 70 | 70 | 70 | 70 |
| SCI-6140-006 | — | 1 | 150 | — | 100 | — | 3.00 | 2.600 | 0.100 | 1.195 | (30.353) | 21 | 35 | 46 | 70 | 70 | 70 | 70 |
| SCI-6140-007 | — | 1 | 150 | — | 100 | — | 5.00 | 2.600 | 0.060 | 1.195 | (30.353) | 21 | 34 | 41 | 58 | 70 | 70 | 70 |
| SCI-6140-009 | — | 1 | 150 | — | 100 | — | 20.0 | 2.600 | 0.002 | 1.195 | (30.353) | 21 | 35 | 41 | 50 | 60 | 70 | 70 |
| 51-321-649 | — | 1 | 250 | 125 | 200 | 125 | 2.00 | 0.360 | 0.090 | 1.195 | (30.353) | — | 24 | 38 | 65 | 70 | 70 | 70 |
| † 51-321-610 | — | 1 | 450 | 240 | 400 | 240 | 1.00 | 0.360 | 0.600 | 1.195 | (30.353) | 7 | 43 | 60 | 70 | 70 | 70 | 70 |

.690 ø T Circuit MIL Qualified Product

(See MIL index on pages CF8-10 for complete MIL part number listing)

| Part Number | M15733 MIL No | Figure | Rated Voltage | | | | I Amp | Min Cap μ F | DCR Max Ohms | Max L (mm) | | Minimum Insertion Loss (dB) | | | | | | |
|-------------|---------------|--------|---------------|----|-------|-----|-------|-----------------|--------------|------------|----------|-----------------------------|---------|---------|-------|--------|---------|-------|
| | | | 85°C | | 125°C | | | | | | | 30 KHz | 150 KHz | 300 KHz | 1 MHz | 10 MHz | 100 MHz | 1 GHz |
| | | | DC | AC | DC | AC | | | | | | In | L | | | | | |
| 51-321-607 | 27-0017 | 1 | — | — | 200 | 125 | 1.50 | 0.250 | 0.133 | 1.195 | (30.353) | — | 19 | 32 | 62 | 70 | 70 | 70 |
| 51-321-608 | 27-0018 | 1 | — | — | 200 | 125 | 4.00 | 0.250 | 0.025 | 1.195 | (30.353) | — | 14 | 21 | 36 | 70 | 70 | 70 |
| 51-321-670 | 54-0017 | 2 | — | — | 300 | 115 | 10.0 | 0.500 | 0.006 | 1.177 | (29.896) | 5 | 20 | 23 | 35 | 60 | 70 | 60 |

† Also available through authorized distributors.

Mouser Electronics

Authorized Distributor

Click to View Pricing, Inventory, Delivery & Lifecycle Information:

API Technologies:

[54-367-054](#) [51-717-001](#) [9050-100-0008](#) [54-310-009](#) [54-367-057](#) [9010-100-0018A](#) [9051-101-0018](#) [51-321-672](#)
[51-322-015](#) [51-344-006](#) [51-353-109](#) [51-359-007](#) [51-444-002](#) [M15733/23-0058](#) [M15733/25-0008](#) [M15733/27-0014](#)
[M15733/34-0001](#) [M15733/38-0002](#) [M15733/38-0004](#) [M28861/01-003TB](#) [M28861/02-006TB](#) [SCI-1021-000](#) [SCI-](#)
[1021-020](#) [SCI-2060-007](#) [SCI-2120-014](#) [SCI-2120-014Q](#) [SCI-2320-006](#) [SCI-6130-009](#) [51-359-086](#) [9051F-100-0000](#)
[M15733/23-0038](#) [M15733/58-0002](#) [SCI-2320-002](#) [SCI-1020-000](#) [51-359-024](#) [51-359-021](#) [51-359-001](#) [51-359-044](#)
[9053-100-0002](#) [9053-100-0001](#) [9200-300-0025](#) [9932-100-6004](#) [M15733/25-0004](#) [51-359-051](#) [51-359-055](#) [54-367-](#)
[007](#) [9051-100-0000](#) [51-322-009](#) [51-359-053](#) [SCI-6140-007A](#) [9000-103-0019](#) [51-359-088](#) [54-310-039](#) [51-323-313](#)
[51-359-085G](#) [51-359-086G](#) [SCI-1020-020](#) [51-320-026](#) [51-353-111](#) [51-353-113](#) [51-353-053](#) [SCI-1150-001](#) [51-353-](#)
[056](#) [51-359-050](#) [51-353-101](#) [51-359-085](#) [51-717-007](#) [51-311-024](#) [9010-100-0013B](#) [9053-100-0008](#) [84084-013T](#)
[9200-303-0095](#) [51-353-091](#) [84084-014](#) [M28861/01-003](#) [84084-015](#) [51-353-110](#) [9053F100-0001](#) [51-353-112](#) [51-](#)
[320-041](#) [SCI-6120-009](#) [SCI-2350-000](#) [SCI-2160-013](#) [9932F-100-6005](#) [51-353-099](#) [SCI-2160-014](#) [SCI-2320-007](#)