

Switching Devices



9/2	Introduction
9/5	5TE8 control switches
9/8	5TE48 pushbuttons
9/11	5TE58 light indicators
9/13	5TE81/82 On/Off switches
9/16	5TL1 On/Off switches
9/20	5TE DC isolators
9/22	5ST busbars for modular installation devices
9/24	5TT4 remote control switches NEW
9/32	5TT4 switching relays
9/34	5TT5 Insta contactors 5TT50 Insta contactors, AC/DC technology
9/37	5TT58 Insta contactors, AC technology
9/41	5TT3 soft-starting devices
9/42	7LF, 5TT3 timers 7LF4 digital time switches
9/47	7LF5 mechanical time switches
9/50	7LF6 timers for buildings
9/53	5TT3 timers for industrial applications

For further technical product information:

[Configuration Manual](#)

[Switching Devices](#)

Article No.: 3ZW1012-5TT57-0AC1

[Siemens Industry Online Support:](#)







www.siemens.com/lowvoltage/product-support





→ Entry type:
 Application example
 Certificate
 Characteristic
 Download
 FAQ
 Manual
 Product note
 Software archive
 Technical data

Switching Devices

Introduction





Overview

Devices	Page	Application	Standards	Used in		
				Non-residential buildings	Residential buildings	Industry
	9/5	For the switching of lighting and other electrical devices up to 20 A. For use in control cabinets for the logical linking of functions.	IEC/EN 60947-3, (VDE 0660-107); IEC/EN 60669-1, (VDE 0632-1); GB 14048.3 CCC	✓	✓	✓
	9/8	To be used as pushbuttons in control systems, e.g. to switch on seal-in circuits or as pushbuttons with maintained-contact function for manual use, as control switches or for the switching of loads up to 20 A.	IEC/EN 60947-3, (VDE 0660-107); IEC/EN 60669-1, (VDE 0632-1); GB 14048.3 CCC	✓	--	✓
	9/11	Light indicators for signaling switching states or faults in systems.	DIN VDE 0710-1-11	✓	--	✓
	9/13	For switching of lighting, motors and other electrical devices. TE81: 20 A TE82: 32 A.	20 A: IEC/EN 60947-3, (VDE 0660-107); IEC/EN 60669-1 32 A: IEC/EN 60947-3, (VDE 0660-107)	✓	✓	✓
	9/16	On/Off switches used for lighting control and for switching motors and other electric loads, for example.	32 A ... 125 A: IEC/EN 60947-3, (VDE 0660-107)	✓	✓	✓
	9/20	The DC isolator is a special switch disconnecter for switching DC loads.	IEC/EN 60947-3; IEC/EN 60669-1; GB 14048.3 CCC	✓	✓	✓
	9/22	For fast and safe connection.	IEC/EN 60439-1, (VDE 0660-500)	✓	--	✓

Devices	Page	Application	Standards	Used in		
				Non-residential buildings	Residential buildings	Industry
	9/24	For the switching of lighting up to 63 A in rooms using several pushbuttons and central On/Off switches.	IEC 60669-1; IEC 60669-2-2; EN 60669-1-1, (VDE 0632) EN 60669-2-2, (VDE 0632-2-2)	✓	✓	✓
	9/32	For the switching of small loads up to 16 A or as coupling devices in control systems.	EN 60947-5-1, (VDE 0660-200) EN 60947-1, (VDE 0660-100) GB 14048.5 CCC	✓	--	✓
5TT5 Insta contactors						
	9/34	Insta contactors 20 A, 25 A, 40 A and 63 A for the switching of heating, lighting, such as fluorescent lamps, incandescent lamps, ohmic or inductive loads.	IEC 60947-4-1; IEC 60947-5-1; IEC 61095; EN 60947-4-1; EN 60947-5-1; EN 61095; VDE 0660; UL 508; GB 14048.4 CCC	✓	✓	✓
	9/37	Insta contactors 20 A, 25 A, 40 A and 63 A for the switching of heating, lighting, such as fluorescent lamps, incandescent lamps, ohmic or inductive loads.	IEC 60947-4-1; IEC 60947-5-1; IEC 61095; EN 60947-4-1; EN 60947-5-1; EN 61095; VDE 0660; NF C 61-480, (NF EN 61095)	✓	✓	✓
	9/41	Protection of machines with transmission, belt or chain drives, conveyor belts, fans, pumps, compressors, packing machines or door operating mechanisms.	EN 60947-4-2, (VDE 0660-117)	--	--	✓

Switching Devices

Introduction

Devices	Page	Application	Standards	Used in		
				Non-residential buildings	Residential buildings	Industry
7LF, 5TT3 timers						
 <p>7LF4 digital time switches</p>	9/42	Minute-precise switching of devices and system components in day, week and year programs. Unique due to the wide variety of functions offered by the Mini and Top versions; for PC programming Astro, Profi and Expert.	IEC 60730-1 and IEC 60730-2-7; EN 60730-1 and EN 60730-2-7; VDE 0631-1 and -2-7	✓	✓	✓
 <p>7LF5 mechanical time switches</p>	9/47	Accurate and 15-minute switching accuracy. With automatic time setting during commissioning and automatic switching to daylight savings.	IEC 60730-1 and IEC 60730-2-7; EN 60730-1 and EN 60730-2-7; VDE 0631-1 and -2-7; UL 60730 UL 917	✓	✓	✓
 <p>7LF6 timers for buildings</p>	9/50	Lighting controls with stairwell lighting timers ensure the safe use of stairwells and save energy. Expanded applications for common rooms and garages, as well as the time switching of ventilators and fluorescent lamps.	IEC 60699; EN 60669, DIN 18015	✓	✓	--
 <p>5TT3 timers for industrial applications</p>	9/53	Multifunctional, delay, wiper, flashing and Off-delay timers in control circuits expand the use of distribution boards in both small and large plants.	IEC 60255; EN 60255	--	--	✓

Overview

Two-way switches are used in control cabinets and distribution boards for switching small loads on/off or over.

Group switches with center position permit the positions open/stop/closed, for example to control counter-clockwise rotation – Off – clockwise rotation.

Control switches in a range of contact versions have an integral control lamp for the On setting.

The auxiliary switch (AS) signals the contact position of the switch. It has the same design as the auxiliary switch used for the miniature circuit breakers (see chapter "Miniature Circuit Breakers").

Benefits

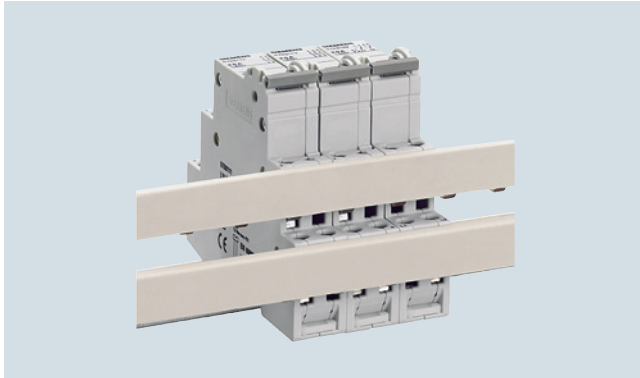

- The control switches can be bus-mounted with each other or with 5TE48 pushbuttons, 5TE58 light indicators or 5TT41 remote control switches and 5TT42 switching relays
- For busbars, see from page 9/22 onwards

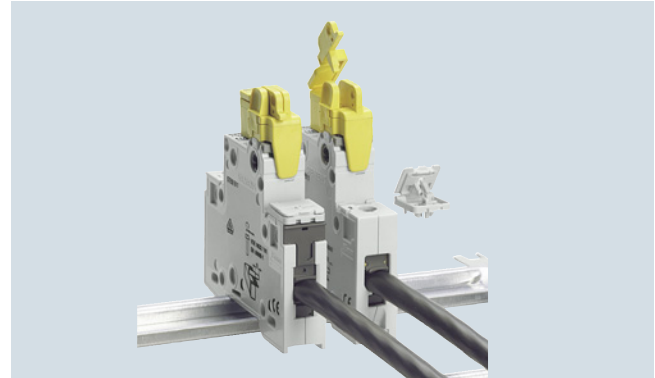

- The handle locking device prevents undesired/inadvertent mechanical on/off switching
- The handle locking device is a universal accessory for all switches and miniature circuit breakers



Technical specifications

			5TE81
Standards			IEC/EN 60947-3 (VDE 0660-107); IEC/EN 60669-1 (VDE 0632-1)
Approvals			IEC/EN 60947-3 (VDE 0660-107) GB 14048.3-2008 CCC
Rated operational current I_e	Per conduct. path	A	20
Rated operational voltage U_e	1-pole	V AC	230
	Multi-pole	V AC	400
Rated power dissipation P_v	Contact per pole	VA	0.7
Thermal rated current I_{th}		A	20
Rated breaking capacity	At p.f. = 0.65	A	60
Rated making capacity	At p.f. = 0.65	A	60
Short-circuit strength			
In conjunction with fuse of the same rated operational current	EN 60269 gL/gG	kA	10
Rated impulse withstand voltage U_{imp}		kV	> 5
Clearances	Open contacts	mm	$2 \times > 2$
	Between the poles	mm	> 7
Creepage distances		mm	> 7
Mechanical service life	Switching cycles		25000
Electrical service life	Switching cycles		10000
Minimum contact load		V; mA	10; 300
Rated short-time currents			
Per conducting path at p.f. = 0.7	Up to 0.2 s	A	650
	Up to 0.5 s	A	400
	Up to 1 s	A	290
	Up to 3 s	A	170
(The respective rated surge current can be calculated by multiplying by a factor of 1.5).			
Terminals	± Screw (Pozidriv)		1
Max. tightening torque		Nm	0.8 ... 1.0
Conductor cross-sections	Rigid	mm ²	1 ... 6
	Flexible, with end sleeve	mm ²	1 ... 6
Permissible ambient temperature		°C	-5 ... +40
Resistance to climate			
At 95% relative humidity	Acc. to DIN 50015	°C	45





Switching Devices

5TE8 control switches

Selection and ordering data

Version	I_e	U_e	Conductor cross-sections	Mounting width	SD	Article No. www.siemens.com/product?Article No.	Price per PU	PU (UNIT, SET, M)	PS	PG	
	A	V AC	up to mm ²	MW	d						
	Two-way switches (20 A)										
	With sealable switch position, separate handle locking device can be retrofitted										
	Retrofittable auxiliary switch										
	1 NO, 1 NC	20	400	6	1	▶	5TE8151		1	1 unit	1BK
	Auxiliary switch cannot be retrofitted										
	2 NO, 2 NC	20	400	6	1		5TE8152		1	1 unit	1BK
3 NO, 1 NC	20	400	6	1		5TE8153		1	1 unit	1BK	
1 CO	20	230	6	1	▶	5TE8161		1	1 unit	1BK	
2 CO	20	400	6	1	▶	5TE8162		1	1 unit	1BK	
	Group switches with center position (20 A)										
	With sealable switch position, separate handle locking device can be retrofitted										
	Auxiliary switch cannot be retrofitted										
1 CO	20	230	6	1	▶	5TE8141		1	1 unit	1BK	
2 CO	20	400	6	1	▶	5TE8142		1	1 unit	1BK	
	Control switches (20 A)										
	With fixed mounted glow lamp 230 V or diode 48 V, with replaceable, white transparent luminescent cap, with sealable switch position, separate handle locking device can be retrofitted										
	Auxiliary switch cannot be retrofitted										
	1 NO	20	230	6	1	▶	5TE8101		1	1 unit	1BK
		20	48	6	1		5TE8101-3		1	1 unit	1BK
	1 NO, for max. 150 m cable length										
		20	230	6	1		5TE8105		1	1 unit	1BK
	2 NO	20	400	6	1		5TE8102		1	1 unit	1BK
3 NO	20	400	6	1		5TE8103		1	1 unit	1BK	
With mounted auxiliary switch (1 NO, 1 NC)											
3 NO	20	400	6	1.5		5TE8108		1	1 unit	1BK	

5TE8 control switches

Version	Mounting width MW	SD d	Article No. www.siemens.com/ product?Article No.	Price per PU	PU (UNIT, SET, M)	PS	PG
 <p>Auxiliary switches (AS) For right-hand-side retrofitting with factory-fitted brackets, for further technical specifications, see chapter "Miniature Circuit Breakers"</p> <p>1 NO + 1 NC 2 NO 2 NC</p>	0.5 0.5 0.5	▶	5ST3010 5ST3011 5ST3012		1 1 1	1 unit 1 unit 1 unit	1AD 1AD 1AD
 <p>Handle locking devices For all 5TE8 switches, can be sealed against undesired/inadvertent mechanical On/Off switching, for padlock with max. 3 mm shackle</p>	--		5ST3801		1	1 unit	1AD
 <p>Spacers Contour for modular devices with a mounting depth of 70 mm; can be snapped onto either side of the busbar, so that two spacers allow for convenient cable routing</p>	0.5		5TG8240		1	2 units	1BK
 <p>Cap sets For manual changing of the luminous plates for 5TE810 control switches Cap set comprising 1 red, green, yellow, white and blue plate each</p>	--		5TG8068		1	1 set	1BK

For busbars for control switches, see page 9/22.

Switching Devices

5TE48 pushbuttons

Overview

The pushbuttons are used in control systems, e.g. to switch on seal-in circuits or as pushbuttons with maintained-contact

function for manual use, as control switches or for the switching of loads up to 20 A.

Benefits



- Pushbuttons with setting function for momentary-contact or maintained-contact operation can be changed over after installation and connection
- Pushbuttons and light indicators with separate infeed in one device. This means they can also be used for voltages other than the switching voltage
- In the case of devices with two pushbuttons and two lamps, each pushbutton must be set separately

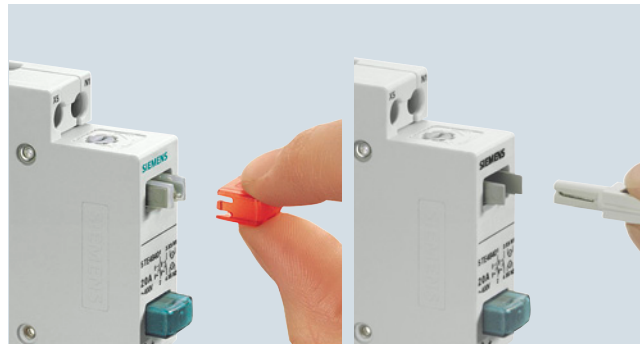

- Pilot lights and caps can also be safely replaced during operation without the use of tools. Functionality is quickly restored.
- Transparent caps in different colors are used to indicate system states according to IEC 60073. Three indications are possible for each device – this saves space







Technical specifications

			5TE48
Standards			IEC/EN 60947-3; IEC/EN 60669-1
Approvals			IEC/EN 60947-3 (VDE 0660-107)
Rated operational current I_e	Per conduct. path	A	20
Rated operational voltage U_e	1-pole	V AC	230
	Multi-pole	V AC	400
Rated power dissipation P_V	Per pole	VA	0.6
Thermal rated current I_{th}		A	20
Rated breaking capacity	At p.f. = 0.65	A	60
Rated making capacity	At p.f. = 0.65	A	60
Rated impulse withstand voltage U_{imp}		kV	> 5
Clearances	Open contacts	mm	2 x > 2
	Between the poles	mm	> 7
Creepage distances		mm	> 7
Mechanical service life	Switching cycles		25000
Minimum contact load		V; mA	10; 300
Rated short-time currents			
Per conducting path at p.f. = 0.7	Up to 0.2 s	A	650
	Up to 0.5 s	A	400
	Up to 1 s	A	290
	Up to 3 s	A	170
(The respective rated surge current can be calculated by multiplying by a factor of 1.5).			
Terminals	± Screw (Pozidriv)	Nm	1
Max. tightening torque			0.8 ... 1.0
Conductor cross-sections	Rigid	mm ²	1 ... 6
	Flexible, with end sleeve	mm ²	1 ... 6
Permissible ambient temperature		°C	-5 ... +40
Resistance to climate			
At 95% relative humidity	Acc. to DIN 50015	°C	45

Power loss of 5TG805.-. LEDs	5TG805.-.
Rated power dissipation P_V	
• LED	VA
	0.4







Color	Color coding according to IEC 60073		
	Safety of people or environment	Process state	System state
Red	Danger	Emergency	Faulty
Yellow	Warning/Caution	Abnormal	
Green	Safety	Normal	
Blue	Stipulation		
White, Gray, Black	No special significance assigned		

Selection and ordering data

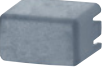
Version	I_e	U_e	Conductor cross-sections	Mounting width	SD	Article No. www.siemens.com/ product?Article No.	Price per PU	PU (UNIT, SET, M)	PS	PG
	A	V AC	up to mm ²	MW	d					
Pushbuttons without maintained-contact function										
	1 NO, 1 NC									
	1 gray pushbutton	20	400	6	1	▶ 5TE4800		1	1 unit	1BK
	1 red pushbutton	20	400	6	1	5TE4805		1	1 unit	1BK
	1 green pushbutton	20	400	6	1	5TE4806		1	1 unit	1BK
	1 yellow pushbutton	20	400	6	1	5TE4807		1	1 unit	1BK
	1 blue pushbutton	20	400	6	1	5TE4808		1	1 unit	1BK
	2 NO, 2 NC NEW									
	1 gray pushbutton	20	400	6	1	5TE4801-2		1	1 unit	1BK
	3 NO, 1 NC NEW									
	1 gray pushbutton	20	400	6	1	5TE4802		1	1 unit	1BK
1 NO, 1 NO										
1 green pushbutton, 1 blue pushbutton	20	400	6	1	5TE4804		1	1 unit	1BK	
Pushbuttons with maintained-contact function										
	1 NO, 1 NC									
	1 gray pushbutton	20	400	6	1	5TE4810		1	1 unit	1BK
	2 NO									
	1 gray pushbutton	20	400	6	1	5TE4811		1	1 unit	1BK
	2 NO, 2 NC NEW									
	1 gray pushbutton	20	400	6	1	5TE48011-2				
	3 NO + N									
	1 gray pushbutton	20	400	6	1	5TE4812		1	1 unit	1BK
	4 NC									
	1 gray pushbutton	20	400	6	1	5TE4813		1	1 unit	1BK
3 NO, 1 NC NEW										
1 gray pushbutton	20	400	6	1	5TE4812-1		1	1 unit	1BK	
2 CO										
1 gray pushbutton	20	400	6	1	5TE4814		1	1 unit	1BK	
Control pushbuttons with maintained-contact function or momentary-contact function and lamp, 230 V, for max. 5 m cable length										
	1 NO, 1 NC									
	1 red pushbutton	20	400	6	1	▶ 5TE4820		1	1 unit	1BK
	1 NO									
	1 red pushbutton	20	230	6	1	▶ 5TE4821		1	1 unit	1BK
	2 NO									
	1 red pushbutton	20	400	6	1	5TE4823		1	1 unit	1BK
2 NC										
1 red pushbutton	20	400	6	1	5TE4824		1	1 unit	1BK	
Control pushbuttons with maintained-contact function or momentary-contact function and lamp, 230 V, for max. 150 m cable length										
	1 NO									
	1 red pushbutton	20	230	6	1	5TE4822		1	1 unit	1BK
Double pushbuttons with maintained-contact function and/or momentary-contact function										
	1 NO and 1 NC, 1 green pushbutton, 1 red pushbutton	20	400	6	1	5TE4830		1	1 unit	1BK
	1 NO, 1 NC and 1 NO, 1 NC 1 green pushbutton, 1 red pushbutton	20	400	6	1	5TE4831		1	1 unit	1BK
Double pushbuttons with maintained-contact function and/or momentary-contact function and two lamps, 230 V, for max. 5 m cable length										
	1 NO and 1 NO, 1 green pushbutton, 1 red pushbutton	20	400	6	1	5TE4840		1	1 unit	1BK
	1 NO and 1 NC, 1 green pushbutton, 1 red pushbutton	20	400	6	1	5TE4841		1	1 unit	1BK

Switching Devices

5TE48 pushbuttons

Version	I_e	U_n	SD	Article No. www.siemens.com/ product?Article No.	Price per PU	PU (UNIT, SET, M)	PS	PG
	mA	V	d					
LEDs for manual replacement								
	White	0.4	12 ... 60 AC/DC	5TG8056-0		1	5 units	1BK
	Red			5TG8056-1				
	Yellow			5TG8056-2				
	Green			5TG8056-3				
	Blue			5TG8056-4				
	White	0.4	115 AC/DC	5TG8057-0		1	5 units	1BK
	Red			5TG8057-1				
	Yellow			5TG8057-2				
	Green			5TG8057-3				
	Blue			5TG8057-4				
	White	0.4	230 AC	5TG8058-0		1	5 units	1BK
	Red			5TG8058-1				
Yellow	5TG8058-2							
Green	5TG8058-3							
Blue	5TG8058-4							
Cap sets, manually replaceable with colored caps with or without lamps								
	Gray, non-transparent (1 set = 5 units)			5TG8060		1	1 set	1BK
	Red, transparent (1 set = 5 units)			5TG8061		1	1 set	1BK
	Green, transparent (1 set = 5 units)			5TG8062		1	1 set	1BK
	Yellow, transparent (1 set = 5 units)			5TG8063		1	1 set	1BK
	Blue, transparent (1 set = 5 units)			5TG8064		1	1 set	1BK
	Black, non-transparent (1 set = 5 units)			5TG8065		1	1 set	1BK
	White, transparent (1 set = 5 units)			5TG8066		1	1 set	1BK
	Red and green (1 set contains 10 lamps per color), Yellow, blue and white (1 set contains 5 lamps per color)			5TG8067		1	1 set	1BK
	Red, green, yellow (1 set = 3 units)			5TG8070		1	1 set	1BK

Overview

Light indicators are used to signal switching states or faults in systems.

They are available as single, double or triple light indicators.

Benefits



- Pilot lights and caps can also be safely replaced during operation without the use of tools
- Transparent caps in different colors are used to indicate system states according to IEC 60073. Three indications are possible for each device
- The lamps are mounted in a slotted base, which protects against polarity reversal. This ensures the correct polarization for all DC applications
- The devices have preferred positions for the N terminals, so that it is possible to bus-mount several devices. This ensures fast and simple installation
- A light indicator with three lamps enables three-phase signaling and "traffic-light signaling" in a single modular width

Technical specifications

			5TE58
Standards			DIN VDE 0710-1-11
Rated operational voltage U_e	Max.	V AC	230 (for different voltages, see 5TG8 lamps)
Rated power dissipation P_v		VA	See 5TG8 lamps
Clearances	Between the terminals	mm	> 7
Terminals	± Screw (Pozidriv)		1
Max. tightening torque		Nm	1.2
Conductor cross-sections	Rigid	mm ²	1.5 .. 6
	Flexible, with end sleeve	mm ²	1 ... 6
Permissible ambient temperature		°C	-5 ... +40
Resistance to climate			
At 95% relative humidity	Acc. to DIN 50015	°C	45

			5TG805.
Rated power dissipation P_v			
• LED	VA		0.4





Color coding according to IEC 60073

Color	Meaning		
	Safety of people and environment	Process state	System state
Red	Danger	Emergency	Faulty
Yellow	Warning/Caution	Abnormal	
Green	Safety	Normal	
Blue	Stipulation		
White	No special significance assigned		

Switching Devices

5TE58 light indicators

Selection and ordering data

Version	U_e	Conductor cross-sections	Mounting width	SD	Article No. www.siemens.com/ product?Article No.	Price per PU	PU (UNIT, SET, M)	PS	PG
	V AC	up to mm ²	MW	d					
	Light indicators for a max. cable length of up to 5 m								
	With 1 red lamp	230	6	1	▶ 5TE5800		1	1 unit	1BK
	With 2 lamps, green and red				▶ 5TE5801		1	1 unit	1BK
	With 3 green lamps				▶ 5TE5802		1	1 unit	1BK
	With 3 lamps, red, yellow and green				▶ 5TE5803		1	1 unit	1BK
	Light indicators for a max. cable length of up to 250 m								
	With 1 red lamp	230	6	1	5TE5804		1	1 unit	1BK
Version	I_e	U_e		SD	Article No. www.siemens.com/ product?Article No.	Price per PU	PU (UNIT, SET, M)	PS	PG
	mA	V		d					
	LEDs for manual replacement								
	White	0.4	12 ... 60 AC/DC		5TG8056-0		1	5 units	1BK
	Red				5TG8056-1		1	5 units	1BK
	Yellow				5TG8056-2		1	5 units	1BK
	Green				5TG8056-3		1	5 units	1BK
	Blue				5TG8056-4		1	5 units	1BK
	White	0.4	115 AC/DC		5TG8057-0		1	5 units	1BK
	Red				5TG8057-1		1	5 units	1BK
	Yellow				5TG8057-2		1	5 units	1BK
	Green				5TG8057-3		1	5 units	1BK
	Blue				5TG8057-4		1	5 units	1BK
	White	0.4	230 AC		5TG8058-0		1	5 units	1BK
	Red				5TG8058-1		1	5 units	1BK
	Yellow				5TG8058-2		1	5 units	1BK
	Green				5TG8058-3		1	5 units	1BK
	Blue				5TG8058-4		1	5 units	1BK
	Cap sets for manual changing of colored caps								
	Red, transparent (1 set = 5 units)				5TG8061		1	1 set	1BK
	Green, transparent (1 set = 5 units)				5TG8062		1	1 set	1BK
	Yellow, transparent (1 set = 5 units)				5TG8063		1	1 set	1BK
	Blue, transparent (1 set = 5 units)				5TG8064		1	1 set	1BK
	White, transparent (1 set = 5 units)				5TG8066		1	1 set	1BK
	Red and green (1 set = 10 lamps per color) Yellow, blue and white (1 set = 5 lamps per color)				5TG8067		1	1 set	1BK
Red, green, yellow (1 set = 3 units)				5TG8070		1	1 set	1BK	

Overview

The devices are used for the switching of lighting, motors and other electrical devices.

For rated currents of 20 A and 32 A, a compact series in a space-saving design is available with up to 4 NO contacts in one MW.

In addition, the 5TE2 device versions can be used as switch disconnectors according to EN 60947-1 And serve as main control switches for the disconnection or isolation of plants according to EN 60204-1.

Benefits

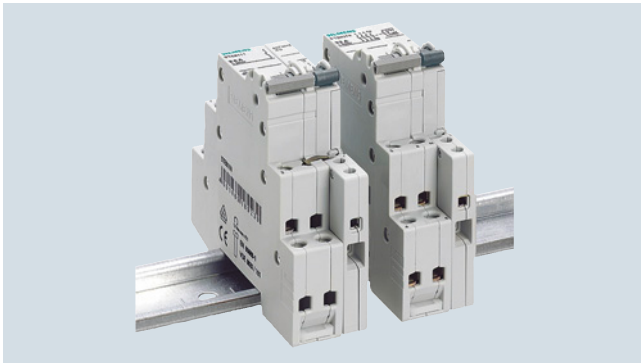

- The switches can be retrofitted with auxiliary switches without the need for tools
- Uniform auxiliary switches for miniature circuit breakers and switches

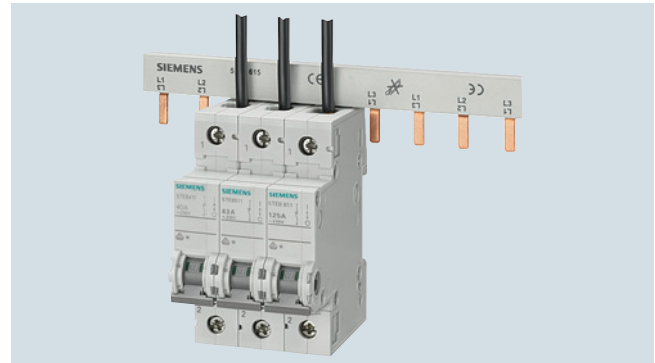

- Clear and visible conductor connection in front of the busbar for safe and easy mounting
- Optional top or bottom infeed as the terminals are identical

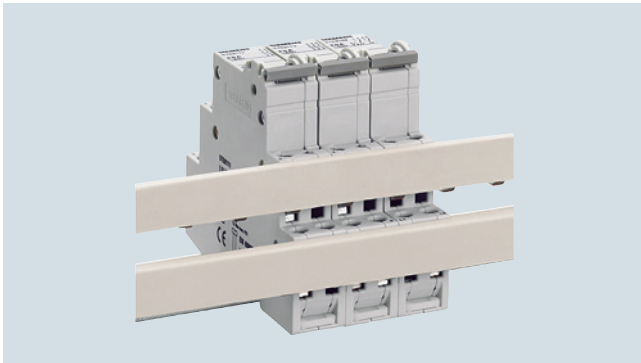

- The 20 A and 32 A switches can be bus-mounted with each other or with 5TE48 pushbuttons, 5TE58 light indicators or 5TT41 remote control switches and 5TT42 switching relays
- For busbars, see [page 9/22](#)

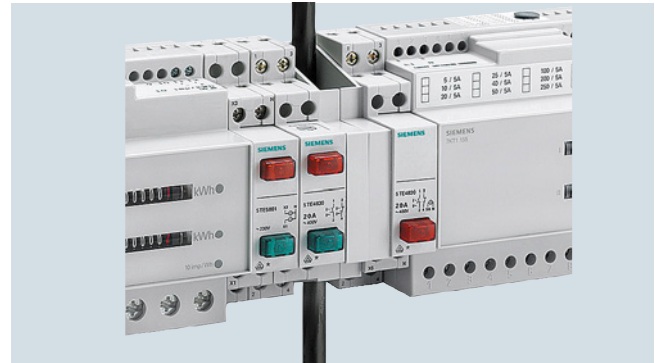

- Spacers can be used as compensating elements and have a width of 0.5 MW. They come with an integrated wiring duct for the insertion of conductors
- Two spacers installed on opposing side therefore offer space for large conductor cross-sections up to 15 mm in diameter

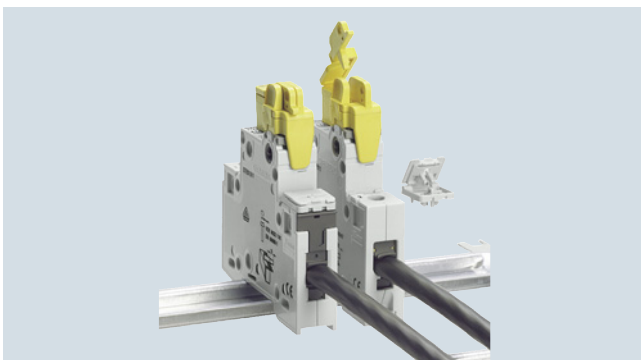

- The handle locking device prevents undesired/inadvertent mechanical on/off switching





Switching Devices

5TE81/82 On/Off switches

Technical specifications

				5TE81	5TE82
Standards				IEC/EN 60947-3, (VDE 0660-107); IEC/EN 60669-1	IEC/EN 60947-3, (VDE 0660-107)
Approvals				IEC/EN 60947-3 (VDE 0660-107)	
Rated operational current I_e	Per conduct. path	A	20	32	
Rated operational voltage U_e	1-pole	V AC	230		
	Multi-pole	V AC	400		
Rated power dissipation P_v	Per pole, max.	VA	0.7		
Thermal rated current I_{th}		A	20	32	
Rated breaking capacity	At p.f. = 0.65	A	60	96	
Rated making capacity	At p.f. = 0.65	A	60	96	
Rated short-circuit making capacity I_{cm} In conjunction with fuse of the same rated operational current	EN 60269 gL/gG	kA	10		
Rated impulse withstand voltage U_{imp}		kV	> 5		
Clearances	Open contacts	mm	2 × > 2		
	Between the poles	mm	> 7		
Creepage distances		mm	> 7		
Mechanical service life		Switching cycles	25000		
Electrical service life		Switching cycles	10000		
Minimum contact load		V; mA	10; 300		
Rated short-time withstand current I_{cw} Per conducting path at p.f. = 0.7	Up to 0.2 s	A	650	1000	
	Up to 0.5 s	A	400	630	
(The corresponding rated surge current can be established by multiplying by factor 1.5.)	Up to 1 s	A	290	450	
	Up to 3 s	A	170	250	
Terminals	± Screw (Pozidriv)		1		
Max. tightening torque		Nm	1.2		
Conductor cross-sections	Rigid	mm ²	1.5 ... 6		
	Flexible, with end sleeve	mm ²	1 ... 6		
Permissible ambient temperature		°C	-5 ... +40		
Resistance to climate At 95% relative humidity	Acc. to DIN 50015	°C	45		

Selection and ordering data

Version	I_e	U_e	Conductor cross-sections	Mounting width	SD	Article No. www.siemens.com/product?Article No.	Price per PU	PU (UNIT, SET, M)	PS	PG	
	A	V AC	up to mm ²	MW	d						
	On/Off switches (20 A and 32 A)										
	With sealable switch position, separate handle locking device can be retrofitted										
	Retrofittable auxiliary switch										
	1 NO	20 32	230	6	1	▶	5TE8111 5TE8211		1 1	1 unit 1 unit	1BK 1BK
	2 NO	20 32	400	6	1	▶	5TE8112 5TE8212		1 1	1 unit 1 unit	1BK 1BK
	3 NO	20 32	400	6	1	▶	5TE8113 5TE8213		1 1	1 unit 1 unit	1BK 1BK
	Auxiliary switch cannot be retrofitted										
3 NO + N	20 32	400	6	1	▶	5TE8114 5TE8214		1 1	1 unit 1 unit	1BK 1BK	
With mounted auxiliary switch											
3 NO + N	20 32	400	6	1.5		5TE8118 5TE8218		1 1	1 unit 1 unit	1BK 1BK	
	Auxiliary switches (AS)										
	For all 5TE8 switches, for right-hand-side retrofitting with factory-fitted brackets, for further technical specifications, see chapter "Miniature Circuit Breakers"										
	1 NO + 1 NC				0.5	▶	5ST3010		1	1 unit	1AD
	2 NO				0.5		5ST3011		1	1 unit	1AD
	2 NC				0.5		5ST3012		1	1 unit	1AD
Auxiliary switches for low power											
1 NO + 1 NC				0.5	▶	5ST3013		1	1 unit	1AD	
2 NO				0.5		5ST3014		1	1 unit	1AD	
2 NC				0.5		5ST3015		1	1 unit	1AD	
	Handle locking devices										
	For all 5TE8 switches, can be sealed against undesired/inadvertent mechanical On/Off switching, for padlock with max. 3 mm shackle										
	Terminal covers										
	For all 5TE85 to 5TE88 switches, in 1 MW per pole version, for covering screw openings, sealable										
	Spacers										
	Contour for modular devices with a mounting depth of 70 mm; can be snapped onto either side of the busbar, so that two spacers allow for convenient cable routing										

Switching Devices

5TL1 On/Off switches

Overview

The new 5TL1 On/Off switches are used for the switching of lighting, motors and other electrical devices. Rated currents range between 32 A and 125 A. The new design of the 5TL1 On/Off switches allows them to be optically perfectly integrated in the series of RCCBs and MCBs.

In addition, the 5TL1 device versions can be used as switch disconnectors according to EN 60947-1. And serve as main control switches for the disconnection or isolation of plants according to EN 60204-1.

Benefits



- Attractive design
- Easily recognizable, colored switch position indication integrated in the operating handle
- Actuating elements in gray
- Ergonomically shaped handle and enclosure contours for user-friendly switching

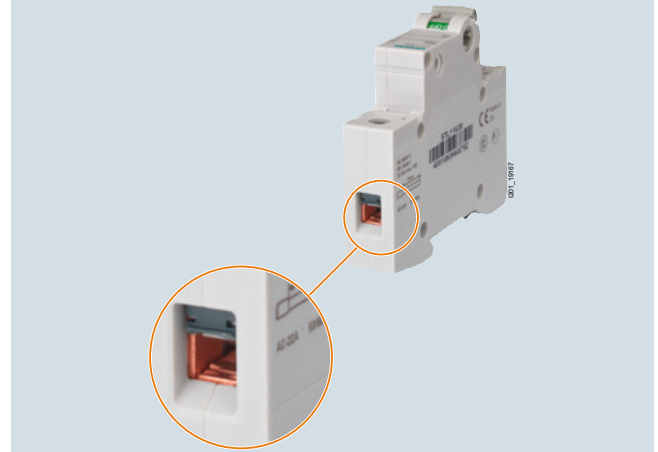

- Simplified cable entry, thanks to square terminal design for joint accommodation of pin busbars with cables from 0.75 to 25 mm²



- Effective shock-hazard protection when grasping
- Manual operation of the snap slide with latch-down option



- Terminal for accommodating 2 conductors of the same cross-section (single-wire up to 2 x 10 mm², finely stranded with end sleeve 2 x 4 mm²)



- Replacement of a device from the busbar-mounted assembly requires no tools



- The On/Off switches are ideal for quick and easy mounting of auxiliary switches





Technical specifications

			5TL1132 5TL1232 5TL1332 5TL1432 5TL1632	5TL1140 5TL1240 5TL1340 5TL1440 5TL1640	5TL1163 5TL1263 5TL1363 5TL1463 5TL1663	5TL1180 5TL1280 5TL1380 5TL1480 5TL1680	5TL1191 5TL1291 5TL1391 5TL1491 5TL1691	5TL1192 5TL1292 5TL1392 5TL1492 5TL1692
Standards			IEC/EN 60947-3 (VDE 0660-107)					
Approvals			EN 60669-1					
Rated operational current I_e	Per conduct. path	A	32	40	63	80	100	125
Rated operational voltage U_e	1-pole Multi-pole	V AC V AC	250 440					
Rated power dissipation P_v	Per pole, max.	VA	0.7	0.9	2.2	3.5	5.5	8.6
Thermal rated current I_{th}		A	32	40	63	80	100	125
Rated breaking capacity AC-22A	At p.f. = 0.65	A	96	120	196	240	300	375
Rated making capacity AC-22A	At p.f. = 0.65	A	96	120	196	240	300	375
Rated short-circuit making capacity I_{cm} In conjunction with fuse of the same rated operational current	EN 60269 gL/gG	kA	10					
Rated impulse withstand voltage U_{imp}		kV	>5					
Clearances	Open contacts Between the poles	mm mm	>7 >7					
Creepage distances		mm	>7					
Mechanical service life	Switching cycles		20000					
Electrical service life	Switching cycles		10000		5000	2000		
Minimum contact load		V; mA	24; 300					
Rated power Switching of resistive loads including moderate overload AC-21	1-pole 2-pole 3/4-pole	kW kW kW	5 9 15	6.5 11 15	10 18 30	13 22 39	16 28 48	16 28 48
Rated short-time withstand current I_{cw} Per conducting path at p.f. = 0.7 (The corresponding rated surge current can be established by multiplying by factor 1.5.)	Up to 0.2 s Up to 0.5 s Up to 1 s Up to 3 s	A A A A	760 500 400 280	950 630 500 350	1500 1000 800 560	2700 1650 1350 800	3400 2100 1700 1000	3400 2100 1700 1000
Terminals Max. tightening torque	± Screw (Pozidriv)	Nm	2 3.5					
Conductor cross-sections	Rigid Flexible, with end sleeve	mm ² mm ²	1 ... 35 1 ... 25			2.5 ... 50 2.5 ... 50		
Permissible ambient temperature		°C	-5 ... +40					
Resistance to climate At 95% relative humidity	Acc. to DIN 50015	°C	45					





Switching Devices

5TL1 On/Off switches

Selection and ordering data

Version	I_e	U_e	Conductor cross-sections	Mounting width	SD	Article No. www.siemens.com/ product?Article No.	Price per PU	PU (UNIT, SET, M)	PS	PG	
		V AC	up to mm ²	MW	d						
	On/Off switches (32 A to 125 A) can be used as switch disconnectors according to EN 60947-1										
	With sealable switch position, separate handle locking device can be retrofitted, auxiliary switches can be retrofitted										
	1 NO, red handle	63	230	35	1	5TL1163-1		1	1 unit	1BK	
		100		50		5TL1191-1		1	1 unit	1BK	
	1 NO, gray handle	32		35		5TL1132-0		1	1 unit	1BK	
		40				5TL1140-0		1	1 unit	1BK	
		63				5TL1163-0		1	1 unit	1BK	
		80		50		5TL1180-0		1	1 unit	1BK	
		100				5TL1191-0		1	1 unit	1BK	
		125				5TL1192-0		1	1 unit	1BK	
	2 NO, red handle	63	400	35	2	5TL1263-1		1	1 unit	1BK	
		100		50		5TL1291-1		1	1 unit	1BK	
	2 NO, gray handle	32		35		5TL1232-0		1	1 unit	1BK	
		40				5TL1240-0		1	1 unit	1BK	
		63				5TL1263-0		1	1 unit	1BK	
		80		50		5TL1280-0		1	1 unit	1BK	
		100				5TL1291-0		1	1 unit	1BK	
		125				5TL1292-0		1	1 unit	1BK	
	3 NO, red handle	63	400	35	3	5TL1363-1		1	1 unit	1BK	
		100		50		5TL1391-1		1	1 unit	1BK	
	3 NO, gray handle	32		35		5TL1332-0		1	1 unit	1BK	
		40				5TL1340-0		1	1 unit	1BK	
		63				5TL1363-0		1	1 unit	1BK	
		80		50		5TL1380-0		1	1 unit	1BK	
		100				5TL1391-0		1	1 unit	1BK	
		125				5TL1392-0		1	1 unit	1BK	
		3 NO + N, red handle	63	400	35	4	5TL1663-1		1	1 unit	1BK
			100		50		5TL1691-1		1	1 unit	1BK
3 NO + N, gray handle		32		35		5TL1632-0		1	1 unit	1BK	
		40				5TL1640-0		1	1 unit	1BK	
		63				5TL1663-0		1	1 unit	1BK	
		80		50		5TL1680-0		1	1 unit	1BK	
		100				5TL1691-0		1	1 unit	1BK	
		125				5TL1692-0		1	1 unit	1BK	
4 NO, gray handle		32		35	4	5TL1432-0		1	1 unit	1BK	
		40				5TL1440-0		1	1 unit	1BK	
		63				5TL1463-0		1	1 unit	1BK	
		80		50		5TL1480-0		1	1 unit	1BK	
	100				5TL1491-0		1	1 unit	1BK		
	125				5TL1492-0		1	1 unit	1BK		
	Auxiliary switches (AS)										
	For all 5TL1 switches, for right-hand-side retrofitting with factory-fitted brackets, for further technical specifications, see chapter "Miniature Circuit Breakers"										
	1 NO + 1 NC				0.5	▶ 5ST3010		1	1 unit	1AD	
	2 NO				0.5	▶ 5ST3011		1	1 unit	1AD	
	2 NC				0.5	▶ 5ST3012		1	1 unit	1AD	
	Auxiliary switches for low power										
	1 NO + 1 NC				0.5	▶ 5ST3013		1	1 unit	1AD	
	2 NO				0.5	▶ 5ST3014		1	1 unit	1AD	
2 NC				0.5	▶ 5ST3015		1	1 unit	1AD		

5TL1 On/Off switches

Version	I_e	U_e	Conductor cross-sections	Mounting width	SD	Article No. www.siemens.com/product?Article No.	Price per PU	PU (UNIT, SET, M)	PS	PG						
	A	V AC	up to mm ²	MW	d											
	Handle locking devices For all 5TL1 switches, can be sealed against undesired/inadvertent mechanical On/Off switching, for padlock with max. 3 mm shackle					5ST3806		1	5 units	1AD						
	Terminal covers For all 5TL1 switches, in 1 MW per pole version, for covering screw openings, sealable					5ST3800		1	10 units	1AD						
	Spacers Contour for modular devices with a mounting depth of 70 mm; can be snapped onto either side of the busbar, so that two spacers allow for convenient cable routing				0.5	5TG8240		1	2 units	1BK						
	Phase connectors For easier wiring in various wiring versions and bus mountings or as a support terminal for conductors from 2.5 mm ² to 50 mm ²							1P	125	230	50	1	5TL1192-4	1	1 unit	1BK
	N conductor connectors For easier wiring in various circuit versions and bus mountings or as a support terminal for N conductors from 2.5 mm ² to 50 mm ² with blue color marking							1P	125	230	50	1	5TL1192-3	1	1 unit	1BK



Switching Devices

5TE DC isolators

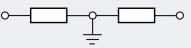

Benefits

- Compact DIN rail device for applications up to 1000 V DC
- Separate switching position indication for unambiguous indication of the switching state
- Compatible with all miniature circuit breaker accessories – reduced stock-keeping
- The effective touch protection when grasping the device considerably exceeds the requirements of BGV A3
- Manual snap-on fixing and release systems that require no tools enable fast assembly and disassembly of switch disconnectors
- Clear and visible conductor connection that can be easily checked in front of the busbar

Technical specifications

		5TE2515-1	
Standards		IEC/EN 60947-3, IEC/EN 60669-1, GB14048.3 CCC	
Rated operational current I_e		A	63
Rated operational voltage U_e	For 4 poles in series	V DC	880
Rated power dissipation P_V	Per pole, max.	W	4.4
Rated short-time withstand current I_{cw}	1000 V DC, 4-pole	A	760
Rated short-circuit making capacity I_{cm}	1000 V DC, 4-pole	A	500
Rated impulse withstand voltage U_{imp}		kV	> 4
Maximum operating voltage U_{max}		V DC	1000
Overvoltage category		II at $U = 880 \text{ V} \dots 440 \text{ V}$	
		I at $U = 1000 \text{ V}$	
Mechanical service life	Switching cycles		10000
Electrical service life	Switching cycles		5000
Utilization category			DC-21B
Minimum contact load		V; mA	24; 300
Terminals	± Screw (Pozidriv)		PZ 2
Max. tightening torque		Nm	2.5 ... 3
Conductor cross-sections	Rigid	mm ²	0.75 ... 35
	Flexible, with end sleeve	mm ²	0.75 ... 25
Permissible ambient temperature		°C	-25 ... +45
Resistance to climate			
At 95% relative humidity	Acc. to DIN 50015	°C	45

Selection and ordering data

Version	I_e	U_e	Conductor cross-sections	Mounting width	SD	Article No. www.siemens.com/ product?Article.No.	Price per PU	PU (UNIT, SET, M)	PS	PG	
	A	V AC	up to mm ²	MW	d						
DC isolators											
1000 V DC, can be used as switch disconnectors according to EN 60947-3, with sealable switch position, separate handle locking device can be retrofitted, auxiliary switch can be retrofitted											
	4 NO	63	--	35	4	5TE2515-1		1	1 unit	1BK	
Auxiliary switches (AS)											
For all 5TE2 DC isolators, for right-hand-side retrofitting with factory-fitted brackets, for further technical specifications, see chapter "Miniature Circuit Breakers"											
	1 NO + 1 NC				0.5	5ST3010		1	1 unit	1AD	
	2 NO				0.5	5ST3011		1	1 unit	1AD	
	2 NC				0.5	5ST3012		1	1 unit	1AD	
	Auxiliary switches for low power										
	1 NO + 1 NC					0.5	5ST3013		1	1 unit	1AD
	2 NO					0.5	5ST3014		1	1 unit	1AD
2 NC					0.5	5ST3015		1	1 unit	1AD	

Configuration

For DC voltages up to 1000 V, the four poles need to be connected in series. In contrast to normal flush-mounting switches, these devices are also fitted with arcing chambers and permanent solenoids to aid the positive quenching of the electric arc in direct currents.

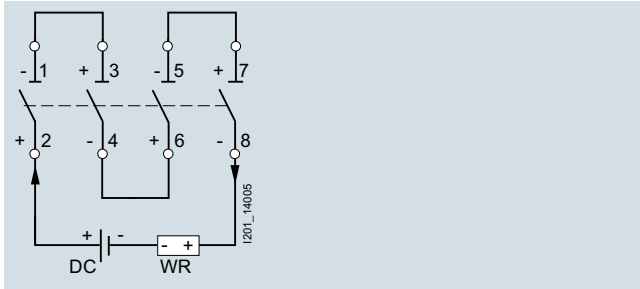

For this reason it is essential to comply with the polarity specifications of the switches when connecting the conductor. Suitable precautions should be taken during plant configuration to ensure there can be no polarity reversal in DC operation.

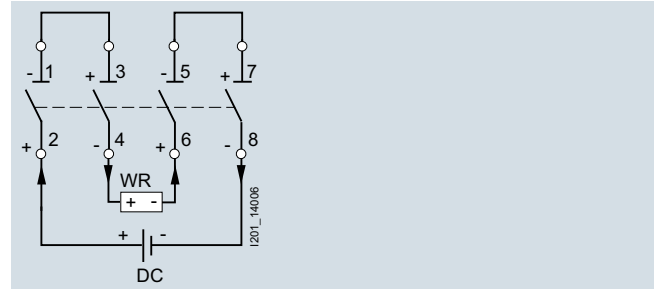

Legend:

WR: Inverter

Switching Devices

5ST busbars for modular installation devices

Overview

Siemens has developed a rail-mounting concept which makes the linking of switching devices just as easy as that of miniature circuit breakers.

The arrangement of the terminals on the devices is adapted to the bus mounting. With only two busbars, this saves considerable mounting time.

Benefits

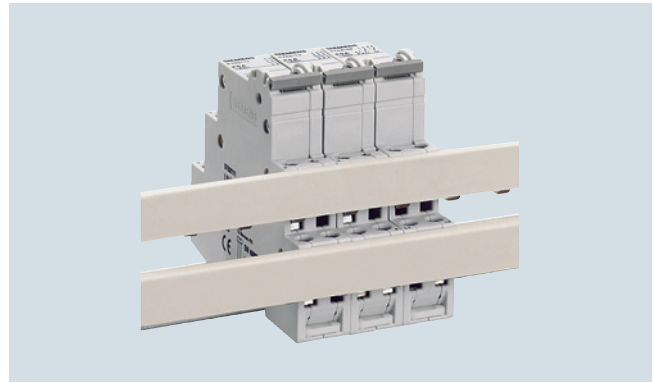
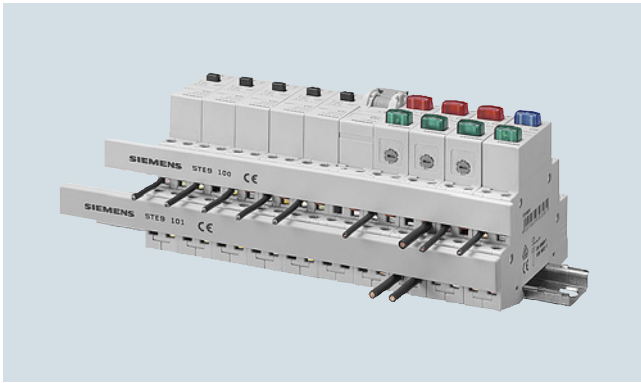

- All 5TE8 switches (20 A and 32 A), 5TE48 pushbuttons, 5TE58 light indicators and 5TT41 remote control switches, 5TT42 switching relays and 5TL1 On/Off switches can be bus-mounted

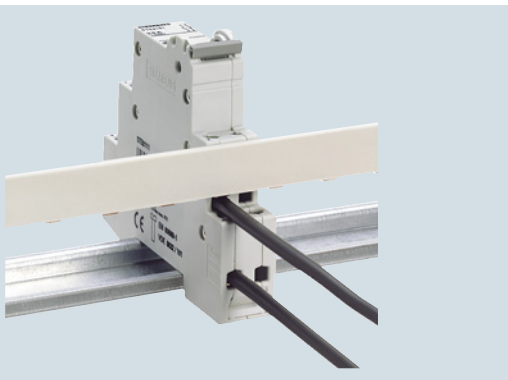

- All 5TE8 switches (20 A and 32 A) in 1 MW can be fed via the single or two-phase busbars. Thus 2 two-phase busbars support a 4-pole infeed



- Infeed: The phase busbar is fed in at the tunnel terminal for conductors up to 6 mm² up to 32 A. No additional feeder terminals required

5ST busbars for modular installation devices

Selection and ordering data

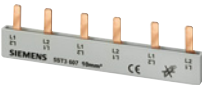
Version	Length mm	SD d	Article No. www.siemens.com/ product?Article No.	Price per PU	PU (UNIT, SET, M)	PS	PG
 <p>Single-phase busbars For all 5TE8, 20 A and 32 A switches In the 12 MW version for the cutting of unused terminal lugs to ensure insulation clearances if one device terminal is to be supplied separately despite being mounted on the bus, modular clearance = 1 MW Busbar infeed to unit terminal with conductor cross-section of 6 mm² up to 32 A. Can be mounted top or bottom in the front or rear terminal area Note: An end cap is not required on single-phase busbars</p>	210		5TE9100		1	10 units	1BK
 <p>Two-phase busbars For all 5TE8, 20 A and 32 A switches In 12 MW version with 1 MW division, whereby the two busbars are offset by 0.5 MW Both copper conductors of the two-phase busbar are insulated together Busbar infeed to unit terminal with conductor cross-section of 6 mm² up to 32 A. Can be mounted from top or bottom, or in the front or rear terminal area, thus allowing realization of a 4-conductor connection using 2 two-phase busbars</p>	220		5TE9101		1	10 units	1BK
 <p>End caps for two-phase busbars End caps for 5TE9101 two-phase busbars to maintain insulation clearances when the bar is being cut 1 set = 10 units</p>	--		5TE9102		1	1 set	1BK
 <p>5ST36 and 5ST37 busbar systems All busbars of the 5ST36 and 5ST37 busbar systems can also be used for all 5TE8 switches from 32 A to 125 A in 1 MW per pole versions (see chapter "Miniature Circuit Breakers").</p>	--						

Switching Devices

5TT4 remote control switches

Overview

Remote control switches up to 16 A and 20 up to 63 A **NEW**

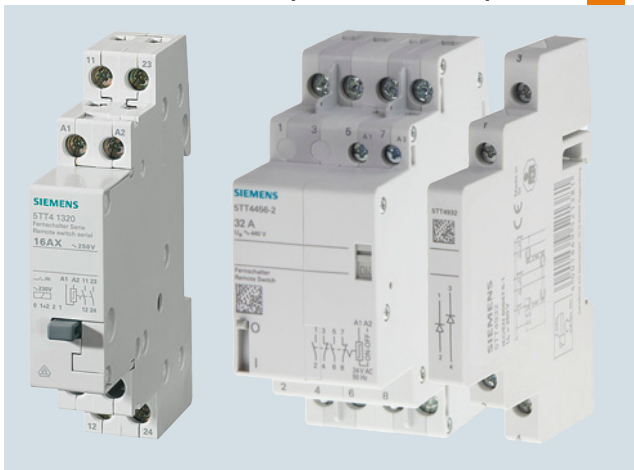

5TT4101-0 remote control switch for AC applications, up to 16 A, 2 NO contacts (left)
 5TT44 remote control switch for AC applications, 2 CO contacts (center)
 5TT4930 auxiliary switch for 5TT44 remote control switches, 1 NO + 1 NC (right)

Remote control switches are used in residential and non-residential buildings, as well as the switchboard engineering sector. They trip in the event of "current inrushes", i.e. pulses, and then electromechanically save the switching position, even in the event of a power failure.

All the devices have the CE mark and can also be equipped with an additional auxiliary switch. All devices have a switching position indication and are operated manually. The switching noise is particularly quiet and meets the requirements of residential buildings.

In addition to the 5TT41 remote control switch for up to 16 A, the 5TT44 version is now also available for 20 ... 63 A (up to 32 A DC).

Benefits

- Remote control switches with central/group switching support convenient and high feature applications
- High functional reliability due to electromechanical design without fault-prone electronics
- The devices have no standby losses
- All devices have a switching position indication and are operated manually
- All the remote control switches can be fitted with an additional auxiliary switch
- The remote control switches can be bus-mounted on 5TE9100 and 5TE9101 busbars; e.g.: bus mounting of the N conductor and/or infeed

Central switching functions

Versions with central On/Off function allow the central switching of all connected remote control switches. This type of central switching can also be actuated using a time switch. All remote control switches can be switched to the ON or OFF switching state, regardless of their current switching state.

Note:

Synchronous switching of the contacts cannot be guaranteed with parallel switching. Products with central/group switching must be used for the mutual control of several remote control switches.

Contact sequences for remote control switches up to 16 A

1 – 2 – 1+2 – 0 or 1 – 0 – 2 – 0 means:

0: No contact closed

1: Only contact 1 closed

2: Only contact 2 closed

1+2: Contact 1 and contact 2 are closed.

The contact positions are constantly changing with each pushbutton impulse.

Note:

Synchronous switching of the contacts cannot be guaranteed with parallel switching. Products with central/group switching must be used for the mutual control of several remote control switches.

Bus mounting

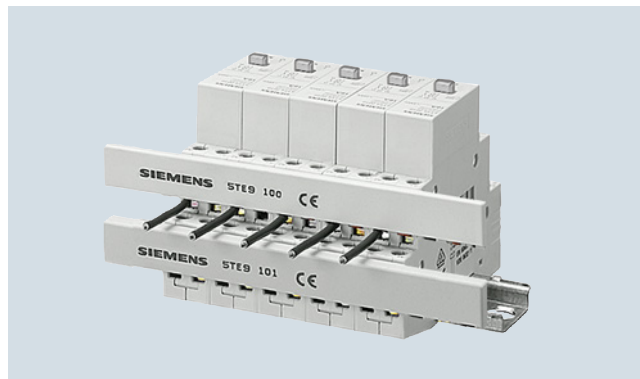

All 5TT41 remote control switches up to 16 A and 5TT44 from 20 ... 63 A can be bus-mounted with each other.

Note:

For suitable busbars, [see page 9/22](#).

Application

Example for 5TT44 remote control switches up to 63 A **NEW**

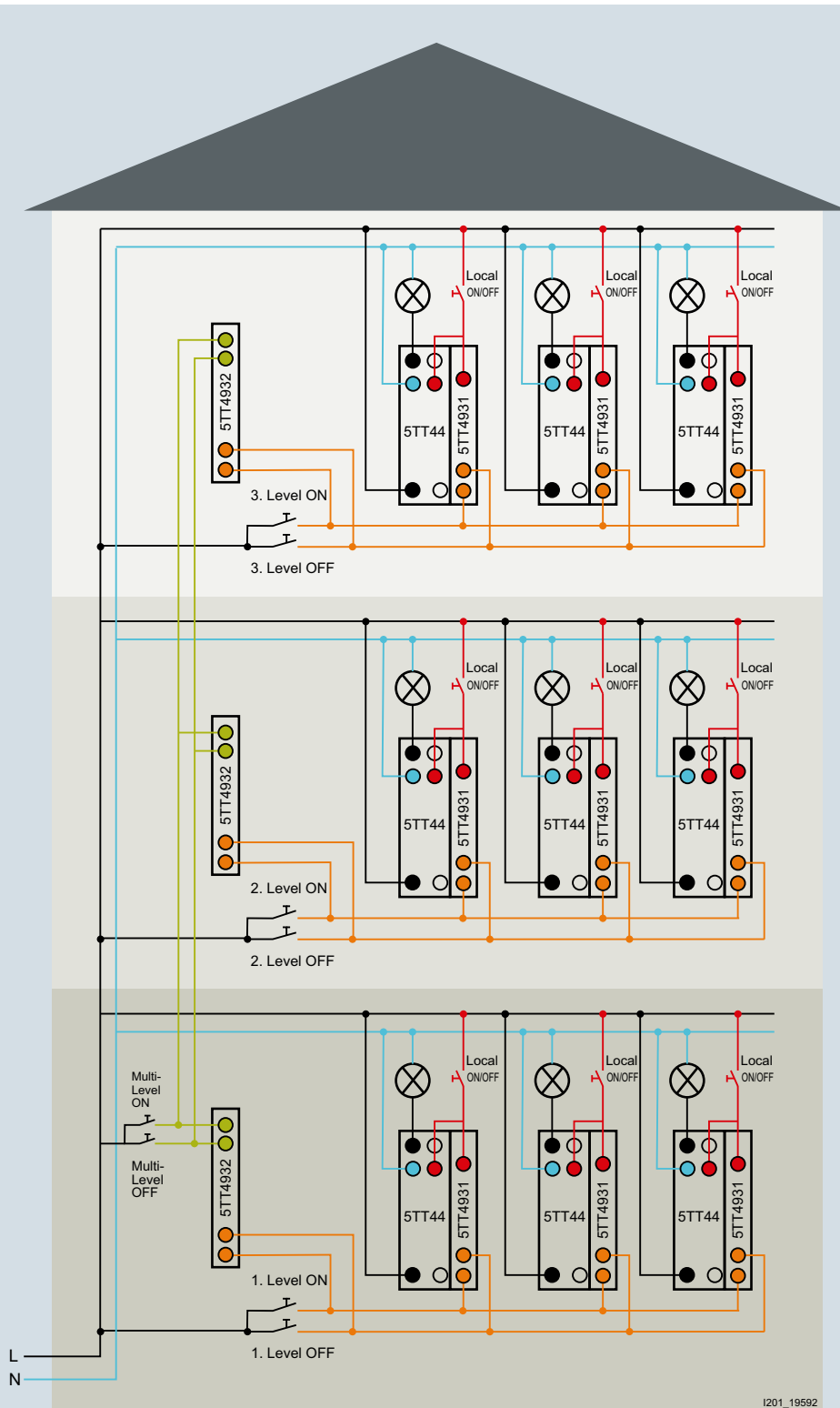

Switching Devices

5TT4 remote control switches

Technical specifications

	5TT41 remote control switches up to 16 A				Auxiliary switches for 5TT41		5TT44 remote control switches from 20 ... 63 A	Auxiliary switches for 5TT44			
	5TT4101 5TT4102 5TT4105 5TT4111 5TT4112 5TT4114 5TT4115	5TT4103 5TT4104	5TT412 5TT415	5TT413 5TT414	5TT4900	5TT4901		5TT4930	5TT4931	5TT4932	
Standards	IEC 60669-1, IEC 60669-2, IEC 60669-3, EN 60669 (VDE 0632), EN 60669-2-2, EN 60669-2-2/A1				EN 60947-1 (VDE 0660 Part 100) EN 60947-5-1 (VDE 0660 Part 200)		IEC 60669-2-2 (up to 32 A) EN IEC 60947-4-1 (40 ... 63 A)	IEC/EN60947-5-1			
Approvals	VDE						CE, CCC (only 20 A, 25 A)	CE, EAC			
Contact type	1 NO 2 NO 1 NO + 1 NC	3 NO 4 NO	1 NO 2 NO 3 NO 1 NO + 1 NC	Series Shutter/ blind	1 CO	1 CO	2 NO 4 NO 1 NO + 1 NC 2 NO + 2 NC 1 CO 2 CO	1 NO + 1 NC	Central	Group	
Manual operation	Yes				--		Yes	No			
Switching position indication	Yes				--		Yes	No			
Rated control voltage U_c	V AC V DC	8 ... 230 12 ... 110			-- --		230, 24 24	250 --			
Primary operating range	$\times U_c$	0.8 ... 1.1				-- --		--			
Rated frequency f_c (AC types)	Hz	50				50/60		50/60			
Rated impulse withstand voltage U_{imp}	kV	4				1		3			
Rated power dissipation P_v	W	--				--		0.3 per pole			
• Magnet coil, only pulse at 16 A	W/VA	4.5/7	9/13	4.5/7			--	--	--	--	
• Magnet coil, for "on" pulse at 20...25 A	W/VA	--	--	--			--	--	--	--	
• Magnet coil, for "on" pulse at 40...63 A	W/VA	--	--	--			13/18; DC: 9/9	--	--	--	
• Per contact at 16 A	W	1.2					--	--	--	--	
• Per contact at 20 A	W	--					1.5	--	--	--	
• Per contact at 25 A	W	--					2	--	--	--	
• Per contact at 32 A	W	--					3	--	--	--	
• Per contact at 40 A	W	--					3	--	--	--	
• Per contact at 63 A	W	--					3.5	--	--	--	
Minimum contact load	V; mA	10; 100 AC				AC/DC 5;1		10; 100 AC	12; 5	--	--
Rated operational current I_e At p.f. = 0.6 ... 1 (AC-15)	A	16						5TT440../41...: 20 5TT442../43...: 25 5TT445...: 32 5TT446...: 40 5TT447...: 63	4	--	--
Rated operational voltage U_e	V AC	--						--	--	250	250
• 1 NO	V AC	250	--	250	--	250	30 AC/DC	--	--	--	--
• 2 NO	V AC	400	--	400	250	--	--	440	--	--	--
• 3 NO	V AC	--	400	400	--	--	--	440	--	--	--
• 4 NO	V AC	400	400	--	--	--	--	440	--	--	--
• 1 NO + 1 NC	V AC	250	--	250	--	--	--	440	250	--	--
Glow lamp load at 230 V	mA	5						--	--		
• With 1 5TT4920 compensator	mA	25						--	--		
• With 2 5TT4920 compensators	mA	45						--	--		
Incandescent lamp load With AC-5b (230V) switching of incandescent lamps for 15000 switching cycles	W	1200						5TT440../41...: 4400 5TT442../43...: 5500 5TT445...: 7000 5TT446...: 8800 5TT447...: 13800	--		
Rated operational power (AC-3)											
• Single-phase, at 230 V	kW	--	--	--	--	--	--	5TT440../41...: 0.5 5TT442../43...: 0.75 5TT445...: 1.1 5TT446...: 2.2 5TT447...: 4	--		
• Three-phase, at 230 V	kW	--	--	--	--	--	--	5TT440../41...: 1.5 5TT442../43...: 2.2 5TT445...: 3 5TT446...: 5.5 5TT447...: 11	--		
• Three-phase, at 400 V	kW	--	--	--	--	--	--	5TT440../41...: 3 5TT442../43...: 4 5TT445...: 5.5 5TT446...: 11 5TT447...: 18.5	--		

5TT4 remote control switches



















	5TT41 remote control switches up to 16 A				Auxiliary switches for 5TT41		5TT44 remote control switches from 20 ... 63 A	Auxiliary switches for 5TT44			
	5TT4101 5TT4102 5TT4105 5TT4111 5TT4112 5TT4114 5TT4115	5TT4103 5TT4104	5TT412 5TT415	5TT413 5TT414	5TT4900	5TT4901		5TT4930	5TT4931	5TT4932	
Different phases Between magnet coil/contact	Permissible				--	--	Permissible	--			
Contact gap	mm	> 1.2				< 1.2		> 3			
Safe separation Creepage distances and clearances between magnet coil/contact	mm	> 6						--	--		
Pushbutton malfunction Protected against continuous voltage, safe due to design		Yes	PTC	Yes ¹⁾	Yes	Yes	Yes	--			
Minimum pulse duration	ms	50						--	--		
Max. switching speed In switching cycles per hour	h ⁻¹	--						5TT440.../41...: 600 5TT442.../43...: 450 5TT445.../43...: 450 5TT446...: 360 5TT447...: 360	--		
Electrical service life At I_e/U_e , p.f. = 0.6; incandescent lamp load 600 W (switching cycles)		50000						50000	100000	--	
Terminals ± screw (Pozidriv)		1						Coil: 1; Contact: 2	1		
Torque	Nm	0.8 ... 1.0				max. 0.5		see conductor cross-sections	0.8		
Conductor cross-sections											
• Rigid	mm ²	1 ... 6				0.5 ... 2.5		Coil: 1 ... 4, Torque: 0.6 Nm Contacts: 20 ... 32 A: 1 ... 10, Torque: 1.2 Nm 40 ... 63 A: 2.5 ... 25, Tightening torque: 2.0 Nm	1 ... 4		
• Flexible, with end sleeve	mm ²	1 ... 6				0.5 ... 2.5		Coil: 1 ... 4, Torque: 0.6 Nm Contacts: 20 ... 32 A: 1 ... 10, Torque: 1.2 Nm 40 ... 63 A: 2.5 ... 25, Torque: 2.0 Nm	1 ... 4		
Resistance to climate At 95% relative humidity acc. to DIN 50015	°C	35						55	55		
Permissible ambient temperature	°C	-10 ... +40						Storage temperature: -30 ... +80 Operating temperature: -25 ... +55	Storage temperature: -30 ... +80 Operating temperature: -25 ... +70		
Degree of protection Acc. to EN 60529		IP20, with connected conductors						IP20	IP20		
Mounting position		Any						Any (not upside down)			

¹⁾ For 2.5 MW 5TT4123-0 devices with PTC.



Switching Devices

5TT4 remote control switches

Selection and ordering data









Contacts	U_e	I_e	U_c	U_c	Mounting width	SD	Article No. www.siemens.com/ product?Article No.	Price per PU	PU (UNIT, SET, M)	PS	PG		
	V AC	A AC	V AC	V DC								MW	d
5TT41 remote control switches up to 16 A													
Remote control switches, auxiliary switches can be retrofitted													
	1 NO	250	16	230	1	▶	5TT4101-0			1 unit	1BK		
				115			5TT4101-1					1 unit	1BK
				24			5TT4101-2					1 unit	1BK
				12			5TT4101-3					1 unit	1BK
	2 NO	400	16	230	1	▶	5TT4102-0			1 unit	1BK		
				115			5TT4102-1					1 unit	1BK
				24			5TT4102-2					1 unit	1BK
				12			5TT4102-3					1 unit	1BK
	3 NO	400	16	230	2	▶	5TT4103-0			1 unit	1BK		
				24			5TT4103-2					1 unit	1BK
	4 NO	400	16	230	2	▶	5TT4104-0			1 unit	1BK		
				24			5TT4104-2					1 unit	1BK
	1 NO + 1 NC	250	16	230	1	▶	5TT4105-0			1 unit	1BK		
				115			5TT4105-1					1 unit	1BK
				24			5TT4105-2					1 unit	1BK
				12			5TT4105-3					1 unit	1BK
	1 NO + 1 NC	250	16	230	1	▶	5TT4105-0			1 unit	1BK		
				115			5TT4105-1					1 unit	1BK
				24			5TT4105-2					1 unit	1BK
				12			5TT4105-3					1 unit	1BK
	1 NO + 1 NC	250	16	230	1	▶	5TT4105-0			1 unit	1BK		
				115			5TT4105-1					1 unit	1BK
				24			5TT4105-2					1 unit	1BK
				8			5TT4105-4					1 unit	1BK
Remote control switches DC applications													
	1 NO	250	16	110	1	▶	5TT4111-1			1 unit	1BK		
				24			5TT4111-2					1 unit	1BK
				12			5TT4111-3					1 unit	1BK
	2 NO	400	16	110	1	▶	5TT4112-1			1 unit	1BK		
				24			5TT4112-2					1 unit	1BK
				12			5TT4112-3					1 unit	1BK
	1 NO + 1 NC	250	16	110	1	▶	5TT4115-1			1 unit	1BK		
				24			5TT4115-2					1 unit	1BK
				12			5TT4115-3					1 unit	1BK
	4 NO	400	16	110	2	▶	5TT4114-1			1 unit	1BK		
				24			5TT4114-2					1 unit	1BK
Remote control switches with central On/Off switching, auxiliary switch cannot be retrofitted													
	1 NO	250	16	230	1.5	▶	5TT4121-0			1 unit	1BK		
				24			5TT4121-2					1 unit	1BK
	2 NO	400	16	230	1.5	▶	5TT4122-0			1 unit	1BK		
				24			5TT4122-2					1 unit	1BK
	3 NO	400	16	230	2.5	▶	5TT4123-0			1 unit	1BK		
				24			5TT4123-2					1 unit	1BK
	1 NO + 1 NC	250	16	230	1.5	▶	5TT4125-0			1 unit	1BK		
				24			5TT4125-0					1 unit	1BK
Remote control switches, with central and group On/Off switching, auxiliary switch cannot be retrofitted													
	1 NO	250	16	230	1.5	▶	5TT4151-0			1 unit	1BK		
				24			5TT4151-2					1 unit	1BK
	2 NO	400	16	230	1.5	▶	5TT4152-0			1 unit	1BK		
				24			5TT4152-2					1 unit	1BK
Series remote control switches Contact sequence 1 – 2 – 1+2 – 0 auxiliary switch cannot be retrofitted													
	2 NO	250	16	230	1	▶	5TT4132-0			1 unit	1BK		
				12			5TT4132-3					1 unit	1BK

5TT4 remote control switches







Contacts	U_e	I_e	U_c	U_c	Mounting width	SD	Article No. www.siemens.com/ product?Article No.	Price per PU	PU (UNIT, SET, M)	PS	PG
	V AC	A AC	V AC	V DC	MW	d					
	Blinds remote control switches Contact sequence 1 – 0 – 2 – 0 auxiliary switch cannot be retrofitted										
2 NO	250	16	230		1	▶	5TT4142-0		1	1 unit	1BK
			24				5TT4142-2		1	1 unit	1BK
			12				5TT4142-3		1	1 unit	1BK
Auxiliary switches for 5TT41 remote control switches											
	Auxiliary switches One device can be retrofitted per remote control switch										
1 CO	250	5			0.5	▶	5TT4900		1	1 unit	1BK
1 CO for low power	30	0.1			0.5	▶	5TT4901		1	1 unit	1BK
		AC/DC									
	Compensators for increasing the glow lamp load by 20 mA										
	250	--			1	▶	5TT4920		1	1 unit	1BK

Switching Devices

5TT4 remote control switches

Contacts	U_e	I_e	U_c	U_c	Mounting width	SD	Article No. www.siemens.com/ product?Article No.	Price per PU	PU (UNIT, SET, M)	PS	PG
	V AC	A AC	V AC	V DC							
5TT44 remote control switches from 20 ... 63 A NEW											
5TT44 remote control switches for AC applications											
	2 NO	440 AC	20 AC	230	--	1	5TT4402-0		1	1 unit	1BK
		440 AC		24	--	1	5TT4402-2		1	1 unit	1BK
	1 NO + 1 NC	440 AC		230	--	1	5TT4405-0		1	1 unit	1BK
		440 AC		24	--	1	5TT4405-2		1	1 unit	1BK
	1 CO	440 AC		230	--	1	5TT4407-0		1	1 unit	1BK
		440 AC		24	--	1	5TT4407-2		1	1 unit	1BK
	2 NO	440 AC	25 AC	230	--	1	5TT4422-0		1	1 unit	1BK
		440 AC		24	--	1	5TT4422-2		1	1 unit	1BK
	1 NO + 1 NC	440 AC		230	--	1	5TT4425-0		1	1 unit	1BK
		440 AC		24	--	1	5TT4425-2		1	1 unit	1BK
	2 CO	440 AC		230	--	2	5TT4428-0		1	1 unit	1BK
		440 AC		24	--	2	5TT4428-2		1	1 unit	1BK
	4 NO	440 AC		230	--	2	5TT4424-0		1	1 unit	1BK
		440 AC		24	--	2	5TT4424-2		1	1 unit	1BK
	2 NO + 2 NC	440 AC		230	--	2	5TT4426-0		1	1 unit	1BK
		440 AC		24	--	2	5TT4426-2		1	1 unit	1BK
	2 NO	440 AC	32 AC	230	--	1	5TT4452-0		1	1 unit	1BK
		440 AC		24	--	1	5TT4452-2		1	1 unit	1BK
	1 NO + 1 NC	440 AC		230	--	1	5TT4455-0		1	1 unit	1BK
		440 AC		24	--	1	5TT4455-2		1	1 unit	1BK
	2 CO	440 AC		230	--	2	5TT4458-0		1	1 unit	1BK
		440 AC		24	--	2	5TT4458-2		1	1 unit	1BK
	4 NO	440 AC		230	--	2	5TT4454-0		1	1 unit	1BK
		440 AC		24	--	2	5TT4454-2		1	1 unit	1BK
	2 NO + 2 NC	440 AC		230	--	2	5TT4456-0		1	1 unit	1BK
		440 AC		24	--	2	5TT4456-2		1	1 unit	1BK
	2 NO	440 AC	40 AC	230	--	2	5TT4462-0		1	1 unit	1BK
		440 AC		24	--	2	5TT4462-2		1	1 unit	1BK
	1 NO + 1 NC	440 AC		230	--	2	5TT4465-0		1	1 unit	1BK
		440 AC		24	--	2	5TT4465-2		1	1 unit	1BK
	2 CO	440 AC		230	--	2	5TT4468-0		1	1 unit	1BK
		440 AC		24	--	2	5TT4468-2		1	1 unit	1BK
	4 NO	440 AC		230	--	4	5TT4464-0		1	1 unit	1BK
		440 AC		24	--	4	5TT4464-2		1	1 unit	1BK
	2 NO + 2 NC	440 AC		230	--	4	5TT4466-0		1	1 unit	1BK
		440 AC		24	--	4	5TT4466-2		1	1 unit	1BK
	2 NO	440 AC	63 AC	230	--	2	5TT4472-0		1	1 unit	1BK
		440 AC		24	--	2	5TT4472-2		1	1 unit	1BK
	1 NO + 1 NC	440 AC		230	--	2	5TT4475-0		1	1 unit	1BK
		440 AC		24	--	2	5TT4475-2		1	1 unit	1BK
	2 CO	440 AC		230	--	2	5TT4478-0		1	1 unit	1BK
		440 AC		24	--	2	5TT4478-2		1	1 unit	1BK
	4 NO	440 AC		230	--	4	5TT4474-0		1	1 unit	1BK
		440 AC		24	--	4	5TT4474-2		1	1 unit	1BK
	2 NO + 2 NC	440 AC		230	--	4	5TT4476-0		1	1 unit	1BK
		440 AC		24	--	4	5TT4476-2		1	1 unit	1BK

5TT4 remote control switches

Contacts	U_e	I_e	U_c	U_c	Mounting width	SD	Article No. www.siemens.com/ product?Article No.	Price per PU	PU (UNIT, SET, M)	PS	PG
	V AC	A AC	V AC	V DC							
5TT4 remote control switches for DC applications											
	2 NO	440 AC	20 DC	--	24	1	5TT4412-5		1	1 unit	1BK
	2 NO	440 AC	25 DC	--	24	1	5TT4432-5		1	1 unit	1BK
	2 NO	440 AC	32 DC	--	24	1	5TT4452-5		1	1 unit	1BK
2 NO											
	1 NO + 1 NC	440 AC	20 DC	--	24	1	5TT4415-5		1	1 unit	1BK
	1 NO + 1 NC	440 AC	25 DC	--	24	1	5TT4435-5		1	1 unit	1BK
	1 NO + 1 NC	440 AC	32 DC	--	24	1	5TT4455-5		1	1 unit	1BK
1 NO + 1 NC											
	1 CO	440 AC	20 DC	--	24	1	5TT4417-5		1	1 unit	1BK
	1 CO	440 AC	25 DC	--	24	1	5TT4437-5		1	1 unit	1BK
	1 CO	440 AC	32 DC	--	24	1	5TT4457-5		1	1 unit	1BK
1 NO + 1 NC											
	1 NO	440 AC	20 DC	--	24	1	5TT4411-5		1	1 unit	1BK
	1 NO	440 AC	25 DC	--	24	1	5TT4431-5		1	1 unit	1BK
	1 NO	440 AC	32 DC	--	24	1	5TT4451-5		1	1 unit	1BK
1 NO											
Auxiliary switches for 5TT4 remote control switches NEW											
	Auxiliary switches										
	1 NO + 1 NC	250 AC	16	--	--	0.5	5TT4930		1	1 unit	1BK
	Auxiliary switches, central with diode For central function (no auxiliary switch)										
	--	250 AC	--	--	--	0.5	5TT4931		1	1 unit	1BK
	Auxiliary switches, group with several diodes For group function (no auxiliary switch)										
	--	250 AC	--	--	--	0.5	5TT4932		1	1 unit	1BK

Switching Devices

5TT4 switching relays

Overview

Switching relays are used in residential, non-residential and industrial buildings for the purpose of contact multiplication. They can be used with safe isolation between coil voltage and contact.

With the 5TE9100 and 5TE9101 busbars, the switching relays can be mounted quickly and safely, e.g. by bus mounting the N conductor and/or infeed.

Note:

For suitable busbars for the 5TT42 switching relays, see [page 9/22](#).

Benefits

- Easy installation due to busbar mounting
- Switching position indication when checking the plant for enhanced safety
- Manual intervention through manual operation

Bus mounting





All 5TT42 switching relays can be bus-mounted with each other.

Technical specifications

		5TT4201-	5TT4202-	5TT4204-	5TT4205-	5TT4206-	5TT4207-	5TT4217-
Standards		EN 60947-5-1, EN 60669-2-2						
Approvals		VDE, CCC						
Contact type		1 NO	2 NO	4 NO	1 NO + 1 NC	1 CO	2 CO	2 CO
Manual operation		Yes						
Rated control voltage U_c	V AC	8 ... 230						
	V DC	--						
Primary operating range	$\times U_c$	0.8 ... 1.1						
Rated frequency f_c	Hz	50						
Rated impulse withstand voltage U_{imp}	kV	4						
Rated power dissipation P_v								
• Magnet coil	W/VA	2.4/3.0	2.4/3.0	4.8/6.0	2.4/3.0	2.4/3.0	2.4/3.0	1.7
• Per contact at 16 A	W	1.0						
Minimum contact load	V AC; mA	10; 100						
Rated operational current I_e		16						
At p.f. = 0.6 ... 1	A	16						
Rated operational voltage U_e		250	400	400	400	250	400	400
Different phases		Permissible						
Between magnet coil/contact		Permissible						
Contact gap	mm	> 1.2					< 1.2	
Safe separation	mm	> 6						
Electrical service life		50000						
At I_e/U_e , p.f. = 0.6; incandescent lamp load 600 W	Switching cycles	50000						
Terminals	\pm Screw (Pozidriv)	1						
Torque	Nm	0.8 ... 1						
Conductor cross-sections		1 ... 6						
• Rigid	mm ²	1 ... 6						
• Flexible, with end sleeve	mm ²	1 ... 6						
Resistance to climate		35						
At 95% relative humidity	Acc. to DIN 50015	°C						
Permissible ambient temperature	°C	-10 ... +40						
Degree of protection	Acc. to EN 60529	IP20, with connected conductors						
Mounting position		Any						

Selection and ordering data

Contacts	U_e	I_e	U_c	U_c	Mounting width	SD	Article No. www.siemens.com/product?Article No.	Price per PU	PU (UNIT, SET, M)	PS	PG			
	V AC	A AC	V AC	V DC								MW	d	
Switching relays for AC voltage														
	1 NO	250	16	230	--	1	▶			1	1 unit	1BK		
				115									▶	
				24										
				12										
				8										
2 NO	400	16	230	--	1	▶			1	1 unit	1BK			
			115									▶		
			24											
			12											
			8											
4 NO	400	16	230	--	2	▶			1	1 unit	1BK			
			115									▶		
			24											
			12											
			8											
1 NO + 1 NC	400	16	230	--	1	▶			1	1 unit	1BK			
			115									▶		
			24											
			12											
			8											
1 CO	250	16	230	--	1	▶			1	1 unit	1BK			
			115									▶		
			24											
			12											
			8											
2 CO	400	16	230	--	1	▶			1	1 unit	1BK			
			115									▶		
			24											
			12											
			8											
Switching relays for direct voltage														
	2 CO	400	16	--	110	1	▶			1	1 unit	1BK		
													30	▶
													24	
													12	
Spacers														
	In the case of higher ambient temperatures, we recommend placing a spacer after every second switching relay for better heat dissipation.				0.5					1	2 units	1BK		
	5TG8240													

Switching Devices

5TT5 Insta Contactors

5TT50 Insta contactors, AC/DC technology

Overview

The Insta contactors are the ideal switching devices for controlling AC/DC control voltage in industrial applications and infrastructure.

In addition to their basic function, they can also be used for the On/Off switching of single-phase and three-phase electrical motors. The 5TT50 Insta contactors meet the requirements of EN 60947 and are approved to UL 508.

The simultaneous switching of lamp loads at varying phases can be achieved with a single contactor, whereby it is essential to strive for/ensure a symmetrical load of the phases. Upstream short-circuit detection devices must disconnect at all poles or must be equipped with phase failure detection. Violations of the specified capacitor load limits may cause excessive inrush peak currents. The level of inrush peak currents is also affected by the following factors:

- Length and cross-section of the installed supply lines
- Type of electronic ballasts
- Brand/make of lamp
- Hum-free

Benefits



- Insta contactors with O/I automatic function enable the testing of a plant via manual switch without the need to apply a control voltage



- Switching position indication for fast recognition of operating states offers greater safety when checking the plant

Technical specifications

			5TT500 2-pole	5TT503 4-pole	5TT504 4-pole	5TT505 4-pole
Standards			EN 60947-4-1; EN 60947-5-1; EN 61095			
Approvals			UL 508; UL File No. E303328; CCC			
Rated frequency at AC f_n	Hz		50/60			
Rated operational voltage U_c	V AC		24, 230	24, 115, 230	24, 230	
	V DC		24, 220	24, 110, 220	24, 230	
Primary operating range	$\times U_c$		0.85 ... 1.1			
Rated operational voltage U_e	V		230	400		
Rated operational current I_e • AC-1/AC-7a, NO contacts • AC-1/AC-7a, NC contacts • AC-3/AC-7b, NO contacts • AC-3/AC-7b, NC contacts	At V AC		Acc. to UL 480; acc. to IEC 440			
	A		20	25	40	63
	A		20	25	40	63
	A		9	8.5	22	30
	A		6	8.5	22	30
Rated power dissipation P_v • Pick-up power (without manual switch or manual switch in "I" position) • Pick-up power (with manual switch in "AUTO" position) • Holding power • Per contact AC-1/AC-7a	VA/W		2.1/2.1	2.6/2.6	5/5	5/5
	VA/W		2.1/4.1	2.6/2.6	5/5	5/5
	VA/W		2.1/2.1	2.6/2.6	5/5	5/5
	VA		1.7	2.2	4	8
Switching times • Closing (NO contacts) • Opening (NO contacts)	ms		15 - 45	15 - 45	15 - 20	
	ms		20 - 50	20 - 70	35 - 45	
Rated impulse withstand voltage U_{imp}	kV		≤ 4			
Contact gap (NO contacts) min.	mm		3.6			
Electrical service life At I_e and load	AC-1/AC-7a	For switching cycles	200000		100000	
	AC-3/AC-7b	For switching cycles	300000	500000		150000
Mechanical service life		For switching cycles	3 million			
Maximum switching frequency At load	AC-1/AC-7a	Switching cycles/h	600			
	AC-3/AC-7b	Switching cycles/h	600			
Switching of resistive loads AC-1 For rated operational power P_s (NO contacts) • Single-phase • Three-phase	V AC		230	400		
	kW		4	5.4	8.7	13.3
	kW		--	16	26	40
Switching of three-phase asynchronous motors AC-3 For rated operational power P_s (NO contacts) • Single-phase • Three-phase	V AC		230	400		
	kW		1.3/0.75	1.3/1.3	3.7/3.7	5/5
	kW		--	4	11	15
Minimum switching capacity	V; mA		≥ 17; 50			
Overload withstand capability Per conducting path (NO contacts only)	At 10 s	A	72	68	176	240
Short-circuit protection, according to coordination type 1 Back-up fuse characteristic gL/gG		A	20	25	63	80
Terminals	± screw (Poqidriv)					
• Coil connection			1	1		
			1	2		
Tightening torques • Coil connection • Main connection	Nm		0.6	0.6		
	Nm		1.2	3.5		
Conductor cross-sections • Coil connection - Solid - Stranded, with end sleeve - AWG cables Tightening torque • Main connection - Solid - Stranded, with end sleeve - AWG cables Tightening torque	mm ²		1.0 ... 2.5			
	mm ²		1.0 ... 2.5			
	AWG		16 ... 10			
	lbs/in.		8			
	mm ²		1.0 ... 10	1.5 ... 25		
	mm ²		1.0 ... 6	1.5 ... 16		
	AWG		16 ... 8	16 ... 4		
	lbs/in.		9	20		
	°C		-15 ... +55 ¹⁾			
	°C		-50 ... +80			
Degree of protection	Acc. to EN 60529		IP 20, with connected conductors			
Acc. to UL 508	I_n	A	20	25	40	63
UL 508 General Use 240 V/480 V	FLA	A	20	25	40	63
UL 508 AC discharge lamps		A	20	25	30	40
UL 508 motor load 240 V	Power	hp	1	3	7.5	10
UL 508 motor load 480 V	Power	hp	--	5	15	20
UL 508 short-circuit at 480 V	K5 fuses	A	20	25	60	70
		kA	5			

¹⁾ Contactors can be operated at ambient temperatures of between -25 °C and +70 °C, but only under special conditions.





For more information, please contact Siemens Support. For questions concerning heat dissipation, please refer to the instructions in the [Configuration Manual "Switching Devices"](#).

Switching Devices

5TT5 Insta Contactors

5TT50 Insta contactors, AC/DC technology

Selection and ordering data

	Contacts	U_e	I_e	U_c		Mounting width	SD	Article No. www.siemens.com/product?Article No.	Price per PU	PU (UNIT, SET, M)	PS	PG
		V AC	A AC	V AC	V DC							
 5TT5000-0	Insta contactors											
	For AC or DC continuous operation, with switching position indication, with DC magnetic system											
	2 NO	230	20	230 24	220 24	1		5TT5000-0 5TT5000-2		1 1	1 unit 1 unit	1BK 1BK
	1 NO, 1 NC	230	20	230 24	220 24	1		5TT5001-0 5TT5001-2		1 1	1 unit 1 unit	1BK 1BK
	2 NC	230	20	230 24	220 24	1		5TT5002-0 5TT5002-2		1 1	1 unit 1 unit	1BK 1BK
	4 NO	400	25	230 115 24	220 110 24	2		5TT5030-0 5TT5030-1 5TT5030-2		1 1 1	1 unit 1 unit 1 unit	1BK 1BK 1BK
	3 NO, 1 NC	400	25	230 24	220 24	2		5TT5031-0 5TT5031-2		1 1	1 unit 1 unit	1BK 1BK
	2 NO, 2 NC	400	25	230 24	220 24	2		5TT5032-0 5TT5032-2		1 1	1 unit 1 unit	1BK 1BK
	4 NC	400	25	230 24	220 24	2		5TT5033-0 5TT5033-2		1 1	1 unit 1 unit	1BK 1BK
	4 NO	400	40	230 24	220 24	3		5TT5040-0 5TT5040-2		1 1	1 unit 1 unit	1BK 1BK
	3 NO, 1 NC	400	40	230 24	220 24	3		5TT5041-0 5TT5041-2		1 1	1 unit 1 unit	1BK 1BK
	2 NO, 2 NC	400	40	230 24	220 24	3		5TT5042-0 5TT5042-2		1 1	1 unit 1 unit	1BK 1BK
	4 NC	400	40	230 24	220 24	3		5TT5043-0 5TT5043-2		1 1	1 unit 1 unit	1BK 1BK
	4 NO	400	63	230 24	220 24	3		5TT5050-0 5TT5050-2		1 1	1 unit 1 unit	1BK 1BK
	3 NO, 1 NC	400	63	230 24	220 24	3		5TT5051-0 5TT5051-2		1 1	1 unit 1 unit	1BK 1BK
	2 NO, 2 NC	400	63	230 24	220 24	3		5TT5052-0 5TT5052-2		1 1	1 unit 1 unit	1BK 1BK
 5TT5000-6	Automatic Insta contactors											
	For AC or DC continuous operation, with switching position indication, with DC magnetic system											
	2 NO	230	20	230 24	220 24	1		5TT5000-6 5TT5000-8		1 1	1 unit 1 unit	1BK 1BK
	1 NO, 1 NC	230	20	230 24	220 24	1		5TT5001-6 5TT5001-8		1 1	1 unit 1 unit	1BK 1BK
	4 NO	400	25	230 24	220 24	2		5TT5030-6 5TT5030-8		1 1	1 unit 1 unit	1BK 1BK
3 NO, 1 NC	400	25	230 24	220 24	2		5TT5031-6 5TT5031-8		1 1	1 unit 1 unit	1BK 1BK	
 5TT5910-0	Auxiliary switches											
	For mounting on right-hand side Max. one auxiliary switch per Insta contactor											
	2 NO	230, AC-15	6	--	--	0.5	▶	5TT5910-0		1	1 unit	1BK
1 NO, 1 NC	230, AC-15	6	--	--		▶	5TT5910-1		1	1 unit	1BK	
	Sealable terminal covers											
	For Insta contactor 20 A											
	For Insta contactor 25 A											
For Insta contactors 40 A and 63 A												
								5TT5910-5		1	2 units	1BK
								5TT5910-6		1	2 units	1BK
								5TT5910-7		1	2 units	1BK

Overview

The 5TT58 Insta contactors are equipped with an AC magnetic system and are ideal for use under harsh conditions. The auxiliary switches can be mounted without tools. When equipped with terminal covers, the devices can also be sealed.

Insta contactors without manual switch

Insta contactors are ideal for a wide range of uses in industry, such as for motors where distribution technology plays a major role, e.g. in installations for heat pumps and air conditioning technology. In addition to their basic function, they can also be used for the On/Off switching of single-phase and three-phase electrical motors.

Insta contactors with manual switch

Insta contactors with manual operation can be switched on and off by hand.

Benefits



- Extremely long service life of 3 million switching cycles
- Safe cable routing through the cable entry funnel
- Insulated right through to the cable entry funnel
- Auxiliary switches can be retrofitted on all versions – even on the 20 A type

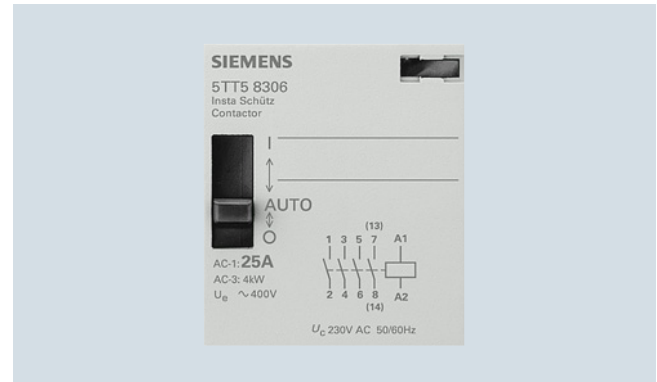

- Insta contactors with O/I/Automatic function enable the testing of a plant by manual switch without the need to apply a control voltage
- Switching position indication for fast recognition of operating states offers greater safety when checking the plant

Switching Devices

5TT5 Insta Contactors

5TT58 Insta contactors, AC technology





Technical specifications

			Insta contactors				Auxiliary switches					
			5TT580.	5TT582., 5TT583.	5TT584.	5TT585.	5TT5910					
Standards			IEC 60947-4-1, IEC 60947-5-1, IEC 61095; EN 60947-4-1, EN 60947-5-1, EN 61095, VDE 0660				IEC 60947-5-1					
Approvals			CCC									
Number of poles			2	4	4	4	2					
Rated frequency at AC			Hz				50/60					
Rated operational voltage U_c			V AC		24, 230	24, 115, 230	24, 230	24, 230	--			
Primary operating range			$\times U_c$		0.85 ... 1.1				--			
Rated operational voltage U_e			V AC		230	400			230/400			
Rated operational current I_e			A		20	25	40	63	6/4 (230/400 V)			
Rated power dissipation P_V			VA/W		6/3.8	10/5	15.4/6		--			
• Pick-up power (without manual switch or manual switch in "I" position)			VA/W		12/10	33/25	62/50		--			
• Pick-up power (with manual switch in "AUTO" position)			VA/W		2.8/1.2	5.5/1.6	7.7/3		--			
• Holding power			VA/W						--			
• Per contact			VA		1.7	2.2	4	8	--			
Switching times			ms		15 ... 25	10 ... 20	15 ... 20		--			
• Closing (NO contacts)			ms		20	20	10		--			
• Opening (NO contacts)			ms		20 ... 30	20 ... 30	5 ... 10		--			
• Closing (NC contacts)			ms		10	10	10 ... 15		--			
• Opening (NC contacts)			ms						--			
Rated impulse withstand voltage U_{imp}			kV		4							
Rated insulation voltage U_i			V		440			500				
Contact gap, minimum			mm		3.6			3.4	4			
Electrical service life			At I_e and load									
• AC-1/AC-7a			For switching cycles		200000			100000	--			
• AC-3/AC-7b			For switching cycles		300000			500000	150000			
Mechanical service life			For switching cycles		3 million							
Maximum switching frequency			At load		In switching cycles/h				600			
Switching of resistive loads AC-1/AC-7a			For rated operational power P_s									
• Single-phase 230 V			kW		4	5.4	8.7	13.3	--			
• Three-phase 400 V			kW		--	16	26	40	--			
Switching of three-phase asynchronous motors AC-3/AC-7b			For rated operational power P_s									
• Single-phase 230 V			kW		1.3 ¹⁾	1.3	3.7	5	--			
• Three-phase 400 V			kW		--	4	11	15	--			
Minimum switching capacity			V; mA		17; 50				12; 5			
Overload withstand capability			Per conducting path (NO contacts only)		At 10 s		A	72	68	176	240	--
Short-circuit protection, according to coordination type 1			Back-up fuse characteristic gL/gG		A		20	25	63	80	6	
Terminals			\pm Screw (Pozidriv)									
• Coil connection					1			1.2	--			
• Main connection					1			3.5	1			
Tightening torques			Nm		0.6				--			
• Coil connection			Nm		1.2			2	0.8			
Conductor cross-sections			mm ²									
• Coil connection			Rigid		1.0 ... 2.5				--			
			Flexible,		1.0 ... 2.5				--			
			with end sleeve									
• Main connection			Rigid		1.0 ... 10			1 ... 25	1 ... 2.5			
			Flexible,		1.0 ... 6			1 ... 16	1 ... 2.5			
			with end sleeve									
Permissible ambient temperature²⁾			°C		-5 ... +55							
• For operation			°C		-30 ... +80							
• For storage												
Degree of protection			Acc. to EN 60529		IP20, with connected conductors							

¹⁾ For NO contacts only.

²⁾ For questions concerning heat dissipation, please refer to the instructions in the [Configuration Manual "Switching Devices"](#).





Selection and ordering data

Version	U_e	I_e	U_c	Mount- ing width	SD	Article No. www.siemens.com/ product?Article No.	Price per PU	PU (UNIT, SET, M)	PS	PG	
	V AC	A AC	V AC	MW	d						
Insta contactors without manual switch											
For alternating current continuous operation, with switching position indication, with AC magnetic system											
 5TT5800-0	2 NO	230	20	230 24	1	▶ 5TT5800-0 ▶ 5TT5800-2		1 1	1 unit 1 unit	1BK 1BK	
	1 NO, 1 NC	230	20	230 24		▶ 5TT5801-0 ▶ 5TT5801-2		1 1	1 unit 1 unit	1BK 1BK	
	2 NC	230	20	230 24		▶ 5TT5802-0 ▶ 5TT5802-2		1 1	1 unit 1 unit	1BK 1BK	
	4 NO	400	25	230 115 24	2	▶ 5TT5830-0 ▶ 5TT5830-1 ▶ 5TT5830-2		1 1 1	1 unit 1 unit 1 unit	1BK 1BK 1BK	
 5TT5830-0	3 NO, 1 NC	400	25	230 115 24		▶ 5TT5831-0 ▶ 5TT5831-1 ▶ 5TT5831-2		1 1 1	1 unit 1 unit 1 unit	1BK 1BK 1BK	
	4 NO for high capacitive loads up to 150 µF	400	25	230	2	▶ 5TT5820-0		1	1 unit	1BK	
	2 NO, 2 NC	400	25	230 24		▶ 5TT5832-0 ▶ 5TT5832-2		1 1	1 unit 1 unit	1BK 1BK	
	4 NC	400	25	230 24		▶ 5TT5833-0 ▶ 5TT5833-2		1 1	1 unit 1 unit	1BK 1BK	
 5TT5840-0	4 NO	400	40	230 24	3	▶ 5TT5840-0 ▶ 5TT5840-2		1 1	1 unit 1 unit	1BK 1BK	
	3 NO, 1 NC	400	40	230 24		▶ 5TT5841-0 ▶ 5TT5841-2		1 1	1 unit 1 unit	1BK 1BK	
	2 NO, 2 NC	400	40	230 24		▶ 5TT5842-0 ▶ 5TT5842-2		1 1	1 unit 1 unit	1BK 1BK	
	4 NC	400	40	230 24		▶ 5TT5843-0 ▶ 5TT5843-2		1 1	1 unit 1 unit	1BK 1BK	
	4 NO	400	63	230 24	3	▶ 5TT5850-0 ▶ 5TT5850-2		1 1	1 unit 1 unit	1BK 1BK	
	3 NO, 1 NC	400	63	230 24		▶ 5TT5851-0 ▶ 5TT5851-2		1 1	1 unit 1 unit	1BK 1BK	
	2 NO, 2 NC	400	63	230 24		▶ 5TT5852-0 ▶ 5TT5852-2		1 1	1 unit 1 unit	1BK 1BK	
	4 NC	400	63	230 24		▶ 5TT5853-0 ▶ 5TT5853-2		1 1	1 unit 1 unit	1BK 1BK	
	Auxiliary switches										
	For mounting on right-hand side Max. one auxiliary switch per Insta contactor										
 5TT5910-0	2 NO	230, AC-15	6	--	0.5	▶ 5TT5910-0		1	1 unit	1BK	
	1 NO, 1 NC	230, AC-15	6	--		▶ 5TT5910-1		1	1 unit	1BK	
Sealable terminal covers											
For Insta contactor 20 A											
					1	▶ 5TT5910-5		1	2 units	1BK	
	For Insta contactor 25 A										
					2	▶ 5TT5910-6		1	2 units	1BK	
For Insta contactors 40 A and 63 A											
				3	▶ 5TT5910-7		1	2 units	1BK		

Switching Devices

5TT5 Insta Contactors

5TT58 Insta contactors, AC technology

Version	U_e	I_e	U_c	Mount- ing width	SD	Article No. www.siemens.com/ product?Article No.	Price per PU	PU (UNIT, SET, M)	PS	PG	
	V AC	A AC	V AC	MW	d						
Insta contactors with manual switch O//Automatic											
For alternating current continuous operation, with switching position indication, with AC magnetic system											
 5TT5800-6	2 NO	230	20	230 24	1	▶ ▶	5TT5800-6 5TT5800-8	1	1 unit	1BK	
	1 NO, 1 NC	230	20	230 24				5TT5801-6 5TT5801-8	1	1 unit	1BK
	4 NO	400	25	230 24	2	▶ ▶		5TT5830-6 5TT5830-8	1	1 unit	1BK
 5TT5830-6	3 NO, 1 NC	400	25	230 24		▶	5TT5831-6 5TT5831-8	1	1 unit	1BK	
	4 NO	400	40	230 24	3	▶	5TT5840-6 5TT5840-8	1	1 unit	1BK	
 5TT5840-6	3 NO, 1 NC	400	40	230 24			5TT5841-6 5TT5841-8	1	1 unit	1BK	
	4 NO	400	63	230		▶	5TT5850-6	1	1 unit	1BK	
	Auxiliary switches										
For mounting on right-hand side Max. one auxiliary switch per Insta contactor											
	2 NO	230, AC-15	6	--	0.5	▶	5TT5910-0	1	1 unit	1BK	
	1 NO, 1 NC	230, AC-15	6	--		▶	5TT5910-1	1	1 unit	1BK	
Sealable terminal covers											
For Insta contactor 20 A											
For Insta contactor 25 A											
For Insta contactors 40 A and 63 A											
					1		5TT5910-5	1	2 units	1BK	
					2		5TT5910-6	1	2 units	1BK	
					3		5TT5910-7	1	2 units	1BK	

Overview

Soft-starting devices are rugged electronic control devices for soft starting of three-phase asynchronous machines. By means of phase-angle control, two of the motor's three phases are influenced in such a way that the current in these phases rises constantly. The motor torque behaves in the same way during start-up. This ensures that the drive can start without jolting. This rules out damage to drive elements because the starting torque does not rise abruptly on direct activation. This characteristic permits a low-cost design of the drive elements.

A clear reduction in starting noise can also be witnessed. On belt conveyor systems, sliding or tilting over of the goods conveyed is avoided. After starting, the power electronics is bypassed by means of an internal relay contact to minimize losses in the device.

Benefits

- Extends the service life of asynchronous motors and mechanical drive components.
- Separate possibility of setting the start-up time and the initial torque. Can be combined with motor brake devices.
- Two-phase motor control
- For motor power outputs up to 5.5 kW

Technical specifications

			5TT3440
Standards			EN 60947-4-2 (VDE 0660-117)
Supply/motor voltage	V AC		400
Primary operating range	$\times U_c$		0.8 ... 1.1
Rated power	VA		3.5
Rated frequency	Hz		50/60
Rated power dissipation P_v	Coil/drive Contacts ¹⁾ per pole		3.5 4.6
Rated output of motor			
- Max.	At 400 V	VA	5500
- Min.	At 400 V	VA	300
Startup voltage		%	30 ... 70
Starting ramp		s	0.1 ... 10
Recovery time		ms	100
Switching frequency			
$3 \times I_N$, $T_{AN} = 10$ s, $v_U = 20\%$		Switching cycles/h	36 (up to 3 kW)
$3 \times I_N$, $T_{AN} = 10$ s, $v_U = 20\%$		Switching cycles/h	20 (from 3 ... 5.5 kW)
Semiconductor fuse	Quick-acting	A	35
Conductor cross-sections	Rigid Flexible, with end sleeve	max. mm ² min. mm ²	2 × 2.5 1 × 0.5
Permissible ambient temperature		°C	-20 ... +60
Resistance to climate	Acc. to EN 60068-1		20/60/4

¹⁾ For rated operational current.

Selection and ordering data

Version	U_e	P_c	Mounting width	SD	Article No. www.siemens.com/ product?ArticleNo.	Price per PU	PU (UNIT, SET, M)	PS	PG
	V AC	W	MW	d					
 Soft-starting devices, mounting depth 55 mm Three-phase, two-phase motor control	400	300 ... 5500	6		5TT3440		1	1 unit	1BK

Technical specifications

			Mini 7LF4401-5	Top 7LF4511 7LF4512	Profi 7LF4521 7LF4522	Astro 7LF4531 7LF4532	Expert 7LF4444	Expert GPS 7LF4541 7LF4542	
Standards			EN 60730-1, -2-7; VDE 0631-1, -2-7						
Approvals			--			UL File No. E301698		--	UL File No. E301698
Supply									
• Rated control supply voltage U_c	V AC		110 ... 240	230	230	230	120/230	230	
	V AC/DC		--	--	24	--	24	--	
- Primary operating range	$\times U_c$		0.85 ... 1.1	0.85 ... 1.1	0.85 ... 1.1 ¹⁾	0.85 ... 1.1	80 ... 253 ^{V1)}	0.85 ... 1.1	
- Frequency ranges	Hz		50 ... 60	50 ... 60	50 ... 60 ²⁾	50 ... 60	50 ... 60 ²⁾	50 ... 60	
• Rated power dissipation P_V	VA		0.035	2	2	2	2.5/4 ³⁾	2	
Channels/contacts									
• Switching channels			1	1 or 2			4	1 or 2	
	- Rated operational voltage U_e	V AC	250						
	- Rated operational current I_e	At p.f. = 1 A At p.f. = 0.6 A	16 10						
• Contacts			1 CO	1 or 2 CO			4 CO	7LF4541: 1 CO 7LF4542: 1 CO + 1 NO	
- Mechanical switching cycles (in millions)			> 5	10					
- Electrical switching cycles	At p.f. = 1		6000 (20 A)	100000					
• Minimum contact load		V; mA	12; 100						
- Incandescent lamp load		A	5	8					
- Fluorescent lamp load		VA	58	60	600		58	600	
	Uncorrected	VA	1400	2300	2000		1400	2000	
- Energy-saving lamp load		W	100	60 VA	1000		100	1000	
Safety									
• Different phases permissible between actuator/contact ⁷⁾			Yes						
• Rated impulse withstand voltage U_{imp}		kV	4.0						
- EMC: Burst		Acc. to IEC 61000-4-4	> 4.4						
- EMC: Surge		Acc. to IEC 61000-4-5	> 2.0						
- Electrostatic discharge		Acc. to IEC 61000-4-2	> 8.0						
• Power reserve storage	Mains/battery	a	6/2	3	5				
- Battery type			Li primary cell						
• Program memory	Captive		--	No	Yes				
• Overvoltage category	Acc. to EN 61010-1		III						
Function									
• Minimum switching sequences			1 min		1 s				
• Make and break cycles			1 min		1 s				
• Clock errors per day	Typical	s/day	+0.3 ± 1	± 1.5	0.1	± 0.1	± 0.2	5)	
• Control input	Terminal S		--	No		Yes (only in the case of 1K clock)		6)	
• Memory spaces			28	28 (2 × 14)	56 (2 × 28)	56 (2 × 28)	4 × 3 × 28	84 (3 × 28)	
- Programs ⁴⁾									
Connections									
• Terminals ± Screw (Pozidriv)			PZ 1						
• Conductor cross-sections of main current paths									
- Rigid, max.		mm ²	4						
- Rigid, min.		mm ²	1.5						
- Flexible with end sleeve	Max.	mm ²	2.5						
Environmental conditions									
• Permissible ambient temperature		°C	-10 ... +55	-20 ... +55					
• Storage temperature		°C	-20 ... +60						
• Resistance to climate	Acc. to EN 60068-1		10/055/21	20/055/21					
• Degree of protection	Acc. to EN 60529		IP20, with connected conductors						
• Safety class	Acc. to EN 60730-1		II						

1) For 24 V devices (7LF4521-2, 7LF4522-2 and 7LF4444-2):
Tolerance -10/+10%; operating range 0.9 ... 1.1 × U_c .

2) For 24 V devices (7LF4521-2, 7LF4522-2 and 7LF4444-2):
Frequency range 0 ... 60 Hz.

3) For 24 V device (7LF4444-2): $P_V = 4$ VA.

4) A program consists of an ON time, an OFF time and assigned ON and OFF days or day blocks.

5) DCF/ GPS atomic clock error, without antenna: +/- 0.1 s/day

6) Control input for connection of the time signal + local coordinates (GPS) from the antenna power supply module





7) The combination of line voltage (230 V) and SELV in combination with a 2K clock is not admissible. This requirement is, however, admissible in the case of 1K clocks and the Expert 4K.

Switching Devices





7LF, 5TT3 Timers

7LF4 digital time switches

Selection and ordering data

	Contacts	U_e	I_e	U_c	Mounting width	SD	Article No. www.siemens.com/ product?Article No.	Price per PU	PU (UNIT, SET, M)	PS	PG
		V AC	A AC	V AC	MW	d					
	Mini digital time switches										
	<ul style="list-style-type: none"> Weekly program 1 channel 										
	1 CO	250	16	110 ... 240	1	▶	7LF4401-5		1	1 unit	1BK
	Top digital time switches										
	<ul style="list-style-type: none"> Weekly program With text-assisted programming concept – language: English Manual daylight-saving adjustment 1 channel 28 programs 										
	1 CO	250	16	230	2		7LF4511-0		1	1 unit	1BK
	<ul style="list-style-type: none"> 2 channels 28 programs (14 per channel) 										
2 CO	250	16	230	2		7LF4512-0		1	1 unit	1BK	
	Profi digital time switches										
	<ul style="list-style-type: none"> Weekly program With text-assisted programming concept languages: 15 languages Simple program creation by means of PC using the software included with the 7LF4941-0 USB adapter Vacation program Random program Operating hours counter, counting range: 65535 h Synchronization 50/60 Hz Cycle function Expert mode Accurate to the second hh:mm:ss Automatic daylight-saving adjustment 										
	<ul style="list-style-type: none"> 1 channel 56 programs 										
	1 CO	250	16	230	2		7LF4521-0		1	1 unit	1BK
	1 CO	250	16	24 AC/DC	2		7LF4521-2		1	1 unit	1BK
	<ul style="list-style-type: none"> 2 channels 56 programs (28 per channel) Channel changeover function 										
	2 CO	250	16	230	2		7LF4522-0		1	1 unit	1BK
2 CO	250	16	24 AC/DC	2		7LF4522-2		1	1 unit	1BK	
	Astro digital time switches										
	<ul style="list-style-type: none"> Weekly program Astro function With text-assisted programming concept languages: 15 languages Simple program creation by means of PC using the software included with the 7LF4941-0 USB adapter Vacation program 1 h test Input disable via PIN code Operating hours counter, counting range: 65535 h Random program Automatic daylight-saving adjustment Daylight-saving adjustment half-year correction Expert mode Synchronization 50/60 Hz Accurate to the second hh:mm:ss 										
	<ul style="list-style-type: none"> 1 channel 56 programs With control input, delay time 0 min ... 23 h 59 min 										
	1 CO	250	16	230	2		7LF4531-0		1	1 unit	1BK
	<ul style="list-style-type: none"> 2 channels 56 programs (28 per channel) Channel changeover function 										
2 CO	250	16	230	2		7LF4532-0		1	1 unit	1BK	





7LF4 digital time switches

Contacts	U_e	I_e	U_c	Mounting width	SD	Article No. www.siemens.com/ product?Article No.	Price per PU	PU (UNIT, SET, M)	PS	PG
	V AC	A AC	V AC	MW	d					
Expert digital time switches										
<ul style="list-style-type: none"> Weekly program Year program 84 programs per channel Exception program (priority program) Astro function Simple program creation by means of PC using the software included with the 7LF4941-0 USB adapter Vacation function 1 h test Input disable via PIN code Operating hours counter, counting range: 65535 h 										
<ul style="list-style-type: none"> Expert GPS Use Profi/Astro data key Article No. 7LF4941-1. With text-assisted programming concept languages: 15 languages Cycle function can be chosen for channel 1 and channel 2 Time synchronization possible in combination with GPS antenna 7LF4541-5 + power supply unit for GPS antenna 7LF4541-4. 										
	1 channel									
	1 CO	250	16	230	2	7LF4541-0		1	1 unit	1BK
<ul style="list-style-type: none"> 2 channels (with channel change function) 										
	1 CO + 1 NO	250	16	230	2	7LF4542-0		1	1 unit	1BK
<ul style="list-style-type: none"> Expert Use Expert data key, Article No. 7LF4940-2. With text-assisted programming concept – languages: German, English, French, Italian, Dutch, Spanish Cycle function can be chosen for channel 1 only 										
	4 channels									
	4 CO	250	16	120/230	6	7LF4444-0		1	1 unit	1BK
	4 CO	250	16	24 AC/DC	6	7LF4444-2		1	1 unit	1BK
Data keys for Profi and Astro digital time switches										
<ul style="list-style-type: none"> Programming at the PC (7LF4941-0 USB adapter and software required) Read-in of programs to the time switch Writing of programs from the time switch Transfer of programs <ul style="list-style-type: none"> From PC to time switch and vice versa From time switch to time switch 										
						7LF4941-1		1	1 unit	1BK
Data keys for Expert digital time switch										
<ul style="list-style-type: none"> Programming at the PC (7LF4940-0 or 7LF4941-0 USB adapter and software required) Read-in of programs to the time switch Writing of programs from the time switch Transfer of programs <ul style="list-style-type: none"> From PC to time switch and vice versa From time switch to time switch 										
						7LF4940-2		1	1 unit	1BK
USB adapter and software for Profi, Astro and Expert digital time switches										
<ul style="list-style-type: none"> For the reading and writing of data keys at the PC With programming software With one Profi/Astro data key 7LF4941-1 Compatible with Profi/Astro data key predecessor model 7LF4940-1 and Expert data key 7LF4940-2 Can be connected over USB interface System requirements: <ul style="list-style-type: none"> Windows 7, Windows Vista, Windows 2000, Windows ME, Windows XP or Windows 98 Second Edition USB connection 40 MB free disk space 										
						7LF4941-0		1	1 unit	1BK

Switching Devices

7LF, 5TT3 Timers

7LF4 digital time switches

	Contacts	U_e	I_e	U_c	Mounting width	SD	Article No. www.siemens.com/ product?Article No.	Price per PU	PU (UNIT, SET, M)	PS	PG
		V AC	A AC	V AC	MW	d					
	Starter kit <ul style="list-style-type: none"> For upgrading with already available USB adapter (7LF4940-0), thus establishing compatibility with new Profi/Astro 7LF4941-1 data keys Compatible with Expert 7LF4940-2 data key and with predecessor model Profi/Astro 7LF4940-1 data key Including Profi/Astro 7LF4941-1 data key + software 						7LF4941-3		1	1 unit	1BK
	Holders for front panel installation <ul style="list-style-type: none"> Universal application for devices from 1 MW to 6 MW Cutout dimensions: <ul style="list-style-type: none"> Height 45^{+0.5} mm Width 23 mm, 41 mm, 59 mm, 77 mm, 95 mm or 113 mm 						7LF9006		1	1 unit	1BK
	Power supply unit for GPS antenna <ul style="list-style-type: none"> For connection between Expert GPS 7LF4541-0 or 7LF4542-0 and GPS antenna 7LF4941-5 230 V, 50/60 Hz Up to 4 Expert GPS per power supply unit 						7LF4941-4		1	1 unit	1BK
	GPS antenna <ul style="list-style-type: none"> Accessories for 7LF4541-0 and 7LF4542-0 Cable, max. 50 m IP 65 Only to be used in combination with the power supply unit for GPS antenna 7LF4941-4 						7LF4941-5		1	1 unit	1BK

Overview



Mechanical time switches with day disk

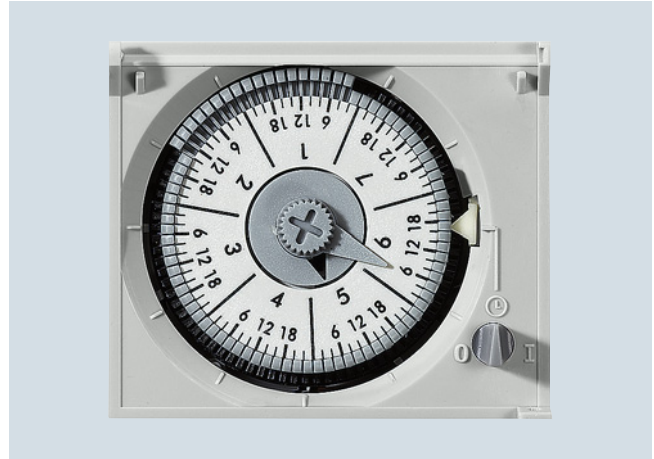

Mechanical time switches with week disk

Synchronous time switches without power reserve

The control gear is driven by a synchronous motor so it is dependent on the power supply frequency. If this frequency is unstable, the devices cannot be used. In the event of a power failure, the time switch will stop.

Quartz-clock time switches with power reserve

A quartz electronic circuit supplies the drive with a stabilized frequency so that the time switch is not dependent on the power supply frequency. In the event of a power failure, the time switch continues to operate on its power reserve.

Switching Devices





7LF, 5TT3 Timers

7LF5 mechanical time switches

Technical specifications

	Synchronous time switches without power reserve				Quartz-clock time switches with power reserve					
	7LF5 300-1	7LF5 300-5	7LF5 300-6	7LF5 301-0	7LF5 301-1	7LF5 301-4	7LF5 301-5	7LF5 301-6	7LF5 301-7	7LF5 305-0
Standards	EN 60730-1, -2-7, UL 917, UL 917, CSA C22.2 No. 14 and 177									
Approvals	VDE, UL file: E301698									
Operating mode	Synchronous				Quartz					
• Time program	Day	Day	Week	Day	Day	Day	Week	Day	Week	Day
Supply										
• Rated control supply voltage U_c	V AC	230					230			
- Primary operating range	$\times U_c$	0.85 ... 1.1					0.85 ... 1.1			
• Rated frequency	Hz	50					50			
- Frequency ranges	Hz	50					50/60			
• Rated power dissipation P_v	VA	1			1	0.2	0.2	1	1	1
Channels/contacts										
• Switching channels		1					1			
- Rated operational voltage U_e	V AC	250					250			
- Rated operational current I_e										
At p.f. = 1	A	16					16			
At p.f. = 0.6	A	4					4			
• Contacts		1 NO	1 CO	1 CO	1 CO	1 NO	1 CO	1 CO	1 CO	1 CO
- Mechanical switching cycles in millions		20				20				
- Electrical switching cycles at p.f. = 1		100000				100000				
• Minimum contact load	V; mA	4; 1					4; 1			
- Incandescent lamp load	A	5					5			
- Fluorescent lamps										
At 7 μ A	VA	60					60			
Uncorrected	VA	1400					1400			
Safety										
• Different phases permissible between actuator/contact		Yes					Yes			
• Electrical isolation, creepage distances and clearances, actuator/contact	mm	8/6					8/6			
• Rated impulse withstand voltage U_{imp} actuator/contact	kV	4					4			
- EMC: Burst acc. to IEC 61000-4-4	kV	> 4.4					> 4.4			
- EMC: Surge acc. to IEC 61000-4-5	kV	> 2.0					> 2.0			
- Electrostatic discharge according to IEC 61000-4-2	kV	> 8.0					> 8.0			
• Power reserve storage	a	--			100 h	6	100 h			
- Minimum loading time	h	--			48	--	48			
- Battery type		--			NiMH cell	Li primary cell	NiMH cell			
- Service life of battery										
At 20 °C	a	--			6	10	6			
At 40 °C	a	--			5					
• Overvoltage category acc. to EN 61010-1		III					III			
Function										
• Minimum switching sequences	min	30	240	30	30	240	30	240	30	30
• Make and break cycles	min	15	120	10	15	120	15	120	10	10
• Switching accuracy	min	± 5	± 30	± 5	± 5	± 30	± 5	± 30	± 5	± 5
• Clock errors per day		System-synchronized			± 2.5 s	± 60 s/year	± 2.5 s			
Connections										
• Terminals \pm Screw (Pozidriv)		PZ 1					PZ 1			
• Conductor cross-sections of main current paths										
- Rigid, max.	mm ²	4					4			
- Rigid, min.	mm ²	1.5					1.5			
- Flexible, with end sleeve	mm ²	2.5					2.5			
- Flexible, without end sleeve	mm ²	4					4			
Environmental conditions										
• Permissible ambient temperature	°C	-10 ... +55					-10 ... +55			
• Storage temperature	°C	-10 ... +60					-10 ... +60			
• Resistance to climate	Acc. to EN 60068-1	10/055/21					10/055/21			
• Degree of protection	Acc. to EN 60529	IP20, with connected conductors					IP20, with connected conductors			
• Safety class	Acc. to EN 61140	II					II			

Selection and ordering data

	Contacts	U_e	I_e	U_c	Mounting width	SD	Article No. www.siemens.com/ product?Article No.	Price per PU	PU (UNIT, SET, M)	PS	PG	
		V AC	A AC	V AC	MW	d						
	Synchronous time switches without power reserve, 1 MW											
	• Day disk											
	1 NO	250	16	230	1	▶	7LF5300-1		1	1 unit	1BK	
	Synchronous time switches without power reserve, 3 MW											
	• Day disk											
		1 CO	250	16	230	3	▶	7LF5300-5		1	1 unit	1BK
	• Week disk											
	1 CO	250	16	230	3	▶	7LF5300-6		1	1 unit	1BK	
	Synchronous time switches without power reserve, for wall mounting											
	• Day disk											
	1 CO	250	16	230	--	▶	7LF5301-0		1	1 unit	1BK	
	Quartz-clock time switches with power reserve											
	• Day disk											
	1 NO	250	16	230	1	▶	7LF5301-1		1	1 unit	1BK	
	Quartz-clock time switches with power reserve and automatic time setting for Central European time zone											
	• Time set automatically during commissioning											
	• Automatic daylight savings											
	• With quartz clock mechanism											
	• Clock accuracy $\pm 0,2$ s/day											
	• 5-year power reserve (time buffer in the event of a power failure)											
• Day disk												
	1 CO	250	16	230	3	▶	7LF5301-4		1	1 unit	1BK	
• Week disk												
	1 CO	250	16	230	3	▶	7LF5301-5		1	1 unit	1BK	
Quartz-clock time switches with power reserve												
Clock accuracy $\pm 2,5$ s/day												
• Day disk												
	1 CO	250	16	230	3	▶	7LF5301-6		1	1 unit	1BK	
• Week disk												
	1 CO	250	16	230	3	▶	7LF5301-7		1	1 unit	1BK	
	Quartz-clock time switches with power reserve, for wall mounting (surface mounting)											
	• Day disk											
	1 CO	250	16	230	--	▶	7LF5305-0		1	1 unit	1BK	
	Holders for front panel installation											
	Universal use for devices from 1 to 6 MW											
	Cutout dimensions: Height $45^{+0,5}$ mm Width 23 mm, 41 mm, 59 mm, 77 mm, 95 mm or 113 mm											
								7LF9006		1	1 unit	1BK

Switching Devices

7LF, 5TT3 Timers

7LF6 timers for buildings

Overview

Siemens stairwell lighting timers enable the required time to be set precisely without tools using the push-to-lock knurling wheel. The stairwell lighting timers in four-wire installations can be switched back on again at any time by simply pressing the switch. A maintained light switch prevents the need for repeated pressing, for example when moving house. The various types are also available with warning of impending switch-off.



Benefits

- Durable switching of different illuminants thanks to patented contact design
- Suitable for energy-saving lamps
- Quiet switching of stairwell lighting timers
- Warning of impending switch-off in accordance with DIN 18015-2 for stairwell lighting in apartment blocks

Technical specifications

		7LF6110	7LF6111	7LF6114	7LF6115
Standards		IEC 60669, EN 60669			
Supply					
• Rated control supply voltage U_c		V AC	230		
- Primary operating range	At 50/60 Hz	$\times U_c$	0.9 ... 1.1		
• Rated power dissipation P_v		VA	Approx. 5		
Setting range		min	0.5 ... 10	0.5 ... 10	3 ... 60
• Accuracy		s	± 30		
Manual switches	Automatic/permanent		Yes		
Minimum push duration		ms	30		
Voltage endurance	At pushbutton input (pushbutton malfunction)		Yes		
Short-circuit strength		A	700	700	
Channels/contacts					
• Switching channels		V AC	250		
- Rated operational voltage U_e		A	16		
- Rated operational current I_e	At p.f. = 1			16	
• Contact gap		mm	> 3		> 3
• Minimum contact load		V; mA	10; 300		
Max. incandescent lamp load		W	2000	2000	
Max. energy-saving lamp load 14 W		Unit(s)	20	20	
Fluorescent lamp load 58 W		Unit(s)	20	20	
- Uncorrected		Unit(s)	2 × 20	2 × 20	
- DUO circuit		Unit(s)	10	10	
- Siemens ECG	1 lamp	Unit(s)	2 × 5	2 × 5	
	2 lamps	Unit(s)			
Glow lamp load		mA	50	50	
Max. fan load		VA	--		
Connections					
• Terminals ± Screw (Pozidriv)			PZ 1		
• Conductor cross-sections of main current paths					
- Rigid		mm ²	1.5 ... 6		
- Flexible, with end sleeve	Min.	mm ²	1		
Environmental conditions					
• Resistance to climate	Acc. to EN 60068-1	°C	-20 ... +50		
• Degree of protection	Acc. to EN 60529		IP20, with connected conductors		

Selection and ordering data

Version	U_e	I_e	U_c	Mounting width	SD	Article No. www.siemens.com/ product?Article No.	Price per PU	PU (UNIT, SET, M)	PS	PG
	V AC	A AC	V AC	MW	d					
	Stairwell lighting timers With switch for continuous light and push-to-lock knurling wheel setting, setting range 0.5 ... 10 minutes For 3-wire circuit, L-momentary contact, not resettable					▶	7LF6110	1	1 unit	1BK
	250	16	230	1						
	For 4-wire circuit, L-momentary contact, resettable, or 3-wire circuit, N-momentary contact, resettable									
	With warning by flashing prior to switching off, for 4-wire circuit, L-momentary contact, resettable, or 3-wire circuit, N-momentary contact, resettable					▶	7LF6111	1	1 unit	1BK
	250	16	230	1						
	With warning by flashing prior to switching off, for 4-wire circuit, L-momentary contact, resettable, or 3-wire circuit, N-momentary contact, resettable									
	Lighting timers With switch for continuous light and push-to-lock knurling wheel setting, with warning by flashing prior to switch-off, setting range 0.5 ... 10 minutes, 4-fold extension of runtime by pressing the pushbutton for 1 second, for 4-wire circuit, L-momentary contact, or 3-wire circuit, N-momentary contact					▶	7LF6114	1	1 unit	1BK
	250	16	230	1						
	Energy-saving timers With switch for continuous light and push-to-lock knurling wheel setting, with warning by flashing prior to switch-off, setting range 3 ... 60 minutes, switch off by pressing pushbutton second time as with remote control switch, for 4-wire circuit, L-momentary contact, resettable, or 3-wire circuit, N-momentary contact, resettable									
250	16	230	1		▶	7LF6115	1	1 unit	1BK	

Switching Devices

7LF, 5TT3 Timers

7LF6 timers for buildings

Circuit diagrams

Typical circuit for 7LF6111 timer in 4-wire circuit, L-momentary, resettable

Usual circuit for new installation with separate cable routing for pushbuttons and lights. The additional DI switch allows external switching to continuous light or a time switch can also be used for this purpose. An additional attic circuit is also available, which operates independently of the timer, but on the same electrical circuit. The timer can be restarted before the set time expires.

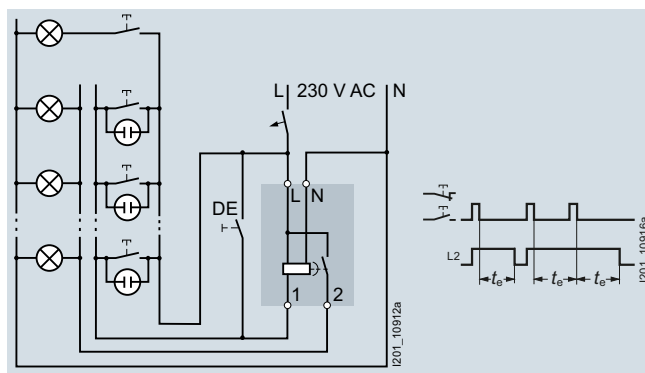

t_e = runtime

Typical circuit for 7LF6111 timer in 3-wire circuit, N-momentary, resettable

Can only be used with a limited number of wires. The timer can be restarted before the set time expires. While this 3-wire circuit with N-momentary contact is technically possible, it does not comply with DIN VDE 0100-460. However, it is used in legacy systems for replacement purposes.

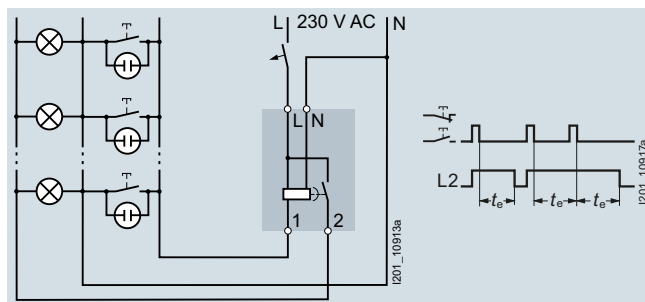

t_e = runtime

Typical circuit for 7LF6115 energy-saving timer with advance warning

The timer is connected in the same way as the 7LF6111 timer in a 4-wire or 3-wire circuit. The energy-saving timer switches on if pressed once and switches off when it is pressed again. If it is not switched off manually, it is automatically switched off after the set time, max. 60 minutes. 20 and 40 seconds before expiry, the light flashes briefly twice (50 ms) to warn of the impending tripping. This allows time to reset the switch while the light is still on. Prior to the warning time, a push of the button ends the timing interval.

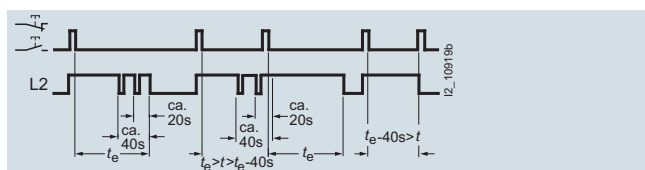

t_e = runtime

Typical circuit for 7LF6110 timer in 3-wire circuit, L-momentary contact, not resettable

Circuit for new installation with shared cable routing for pushbuttons and lights. The timer can only be restarted after the set time expires.

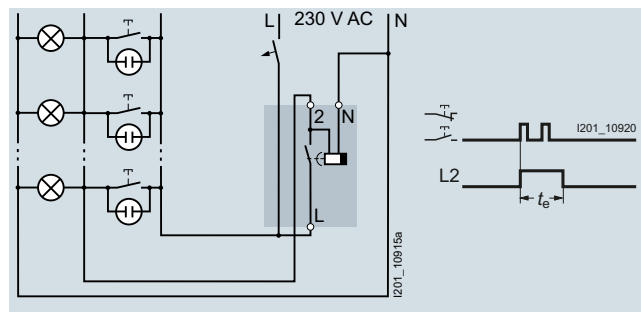

t_e = runtime

Typical circuit for 7LF6113 energy-saving timer with advance warning

The timer is connected in the same way as the 7LF6111 timer in a 4-wire or 3-wire circuit. 20 and 40 seconds before expiry, the light flashes briefly twice (50 ms) to warn of the impending tripping. This allows time to reset the switch while the light is still on.

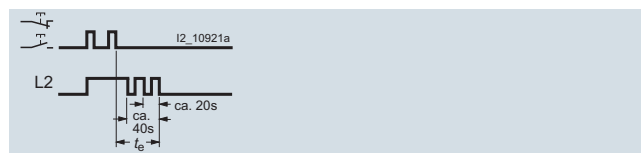

t_e = runtime

Typical circuit for 7LF6114 energy-saving timer with advance warning

The timer is connected in the same way as the 7LF6111 timer in a 4-wire or 3-wire circuit. When pressed, the lighting timer switches on for the set runtime, up to 10 minutes. If the switch is pressed for more than one second, the light is switched on for four times the set time, i.e. up to 40 minutes. The last press of the pushbutton is definitive. 20 and 40 seconds before expiry, the light flashes briefly twice (50 ms) to warn of the impending tripping. This allows time to reset the switch while the light is still on. The timing interval restarts each time the button is pressed.

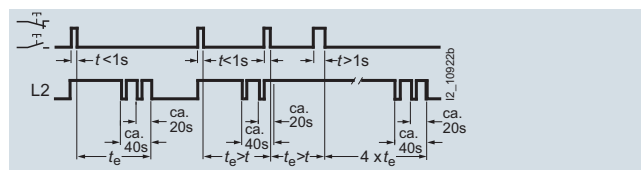

t_e = runtime

Overview

Time relays are primarily used in series applications where the use of PLC controls is too labor and cost-intensive. Multifunction relays with a range of functionalities and clear and intuitive operation are now market standard.

Benefits

- Suitable for universal use because the devices can be operated with 12 - 240 V AC/DC and work across a broad range from seconds to hours
- An off-delay without auxiliary power supports expanded application

Technical specifications

		5TT3185	5TT3181
Standards		DIN EN 60255; DIN VDE 0435-110	
Supply			
• Rated control supply voltage U_c	V AC	12 ... 240	220 ... 240
- Primary operating range	V DC	12 ... 240	--
	$\times U_c$	0.8 ... 1.1	
• Rated frequency f_n	Hz	45 ... 400	50/60
• Rated power dissipation P_v	VA	Approx. 1.5	Approx. 5
Setting ranges			
See setting ranges, timing intervals			
Recovery time	ms	15 ... 80	Approx. 40
Contacts			
• Switching channels			
- Rated operational voltage U_e	V AC	250	
- Rated operational current I_e	A	4	8
• Contact gap	mm	μ contact	
- Minimum contact load	V; mA	10; 300	
Rated impulse withstand voltage U_{imp}	Input/output	kV	> 4
Electrical service life	In switching cycles	1 A	1.5×10^5
	At AC-15		-- 1.5×10^5
Connections			
• Terminals \pm Screw (Pozidriv)			2
• Conductor cross-sections of main current paths			
- Rigid, max.	mm ²	2×2.5	
- Flexible, with end sleeve, min.	mm ²	2×1.5	
Environmental conditions			
• Permissible ambient temperature		°C	-40 ... +60
• Resistance to climate	Acc. to EN 60068-1		40/60/4

Selection and ordering data

Contacts	U_e	I_e	U_c	Mounting width	SD	Article No. www.siemens.com/ product?Article No.	Price per PU	PU (UNIT, SET, M)	PS	PG
Multifunction timers										
Programmable for: response delay; passing make contact function; delayed pulse generator; clock generator starting with impulse; off-delay; pulse converter; passing break contact function; response/off-delay										
1 CO	250	4	12 ... 240 DC 12 ... 240 AC	1	▶	5TT3185		1	1 unit	1BK
Delay timers										
1 CO	250	8	220 ... 240 AC	1	▶	5TT3181		1	1 unit	1BK



Switching Devices

7LF, 5TT3 Timers

5TT3 timers for industrial applications

More information

5TT3185 multifunction timers

Setting aids

The period of the flashing of the green LED 1 when set for a timing interval is $1 \text{ s} \pm 4\%$, which can therefore be used as a setting aid. This is particularly useful in the lower time setting range and for long delay times because of the accuracy of the multiplication factors between the individual time ranges.

Example:

Delay time to be set: 40 min.

Using the fine setting, this delay time can be set within the setting range 3 ... 300 min. However, in this case it takes a long time to check the time and requires several operational sequences in real time. To speed up the setting process, the setting range is switched to 0.03 ... 3 min. In this case, the required value corresponds to a delay time of 0.4 min (= 24 s). The timing interval is triggered and the potentiometer is set to 24 flashing periods of the yellow LED 2. The device is then set back to the setting range 3 ... 300 min and the setting process is completed.

Time operation interruption/time addition

For the functions AV, EW, IE, BI, the timing interval can be interrupted at any time by activating B1 (+) and continued again by removing the control voltage (time addition).

Control input B1

The functions RV, IF, AW, AV/RV can be controlled using the control input B1 (+) with potential against terminal A2. The auxiliary voltage of terminal A1 can be used for this purpose, as well as any other voltage within the range 12 ... 240 V AC/DC. The operation of parallel loads (e. g. contactors) from B1 (+) to A2 is also permissible.

If voltage is simultaneously applied to the control input B1 (+) and A1 for the IF function, this triggers an output pulse with the set time interval t_1 .

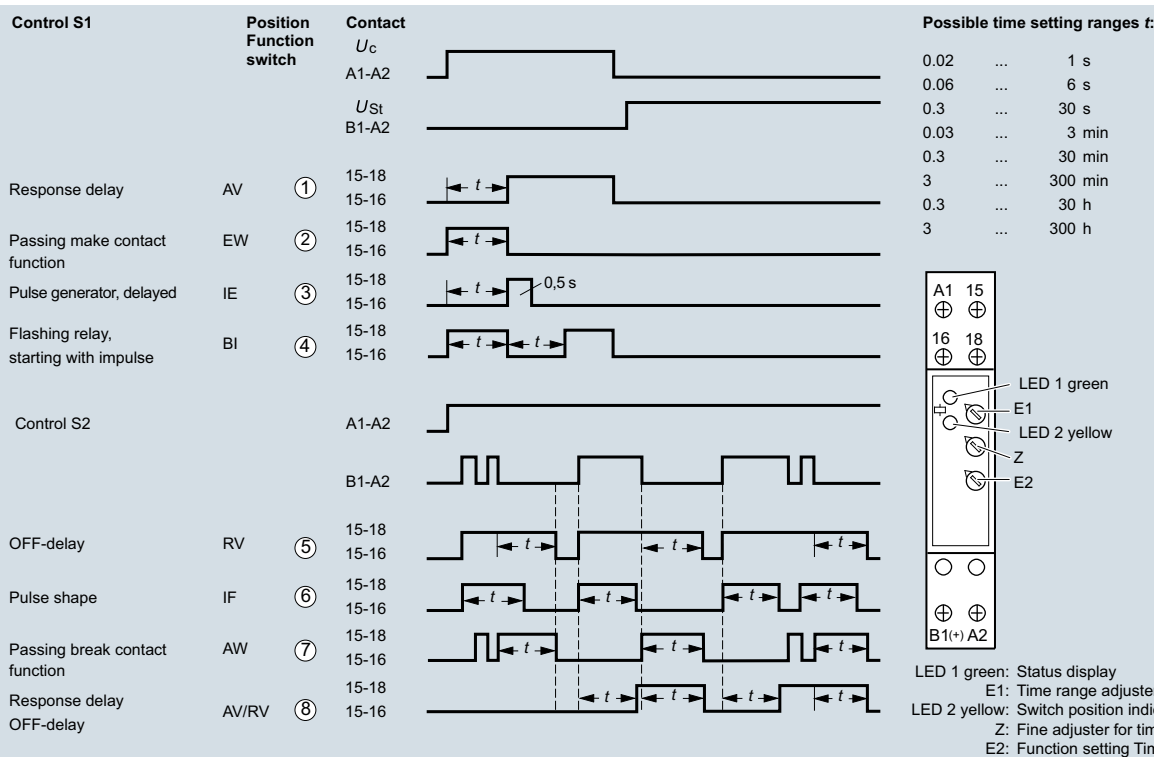

Control S1

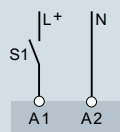

Contact S1
For the functions: response delay, passing make contact function, pulse generator delayed, clock generator – (start with pulse) – the timing interval is triggered by closing the switching contact S1.

Control S2

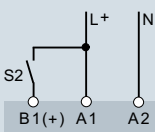

Contact S2
The functions: off-delay, pulse shape, passing break contact function, response and off-delay are triggered by continuous power supply over the control contact S2 between A1 and B1 (+).

User interfaces

- LED 1 Status display
- LED 2 Switching position indication
- E1 Setting range adjuster
- Z Fine adjuster for setting ranges
- E2 Function settings for timing intervals

Device displays

- LED 1 Lights up if operational voltage is applied (green)
- LED 2 indicates the timing interval and state of the equalizing relay (yellow)
 - Continuous light
 - Off output relay not activated, no timing interval
 - On output relay not activated, no timing interval
 - Flashing light
 - Short on, long off
 - Output relay not activated, timing interval
 - Short on, long off
 - Output relay activated, timing interval

Front view

- LED 1 green: Status display
- LED 2 yellow: Switching position indication
- E1: Setting range adjuster
- Z: Fine adjuster for setting ranges
- E2: Function settings for timing intervals