



SURFACE10 BC/UX

ALUMINIUM SURFACE PROFILE

ALUMINOWY PROFIL NAWIERZCHNIOWY

- mounting plates not visible
- decorative and lighting profile
- wide range of accessories, 6 types of covers
- maximum LED strip width: 10 mm
- ukryte mocowanie
- profil dekoracyjno oświetleniowy
- szeroki wybór akcesoriów, 6 rodzajów kloszy
- maksymalna szerokość taśmy LED: 10 mm

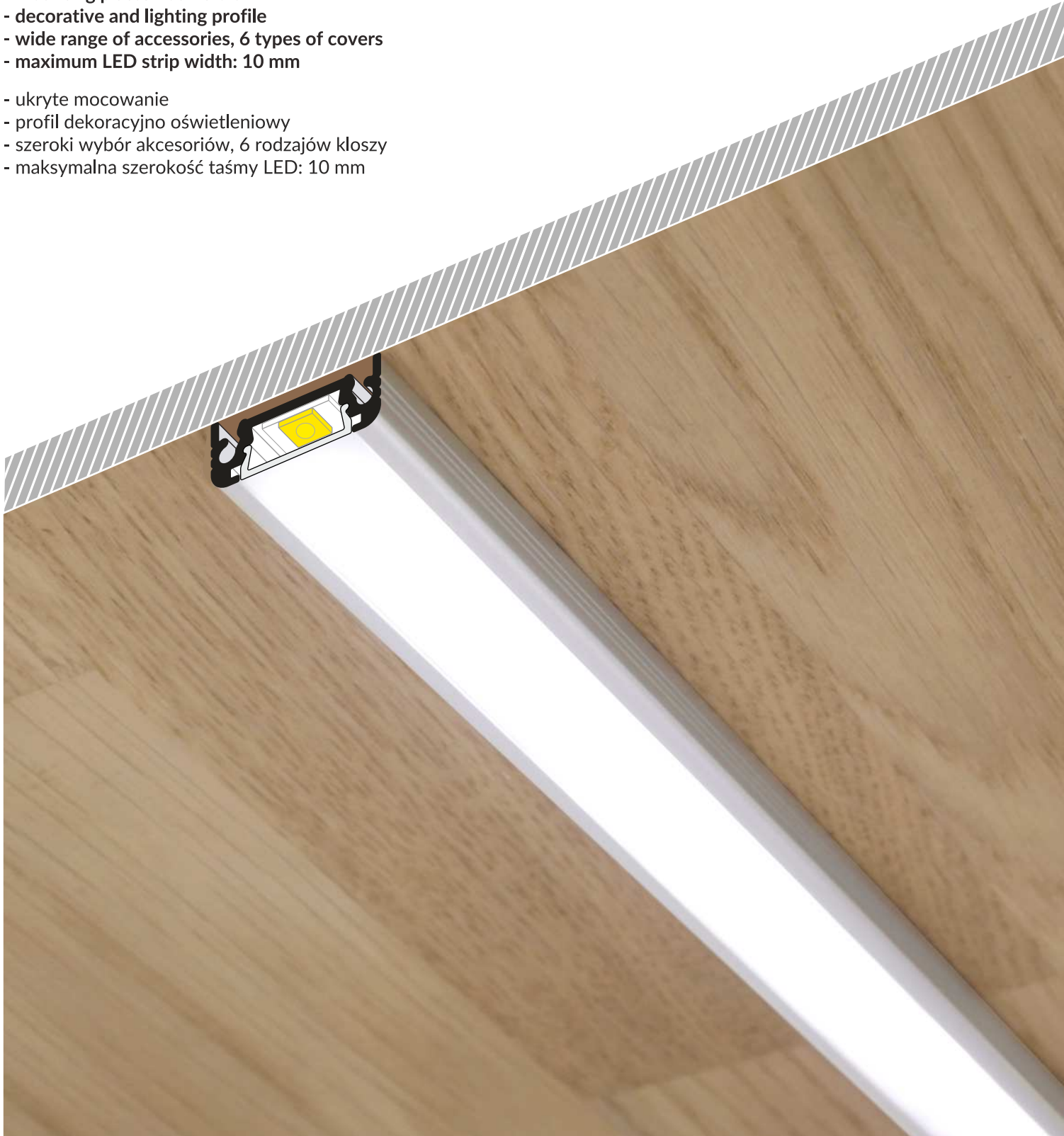

SIMILAR IN THE OFFER / PODOBNE W OFERCIE

SLIM8
A/Z

SMART10
A/Z

BEGTON12
J/S

SURFACE14
EF/TY

LINEA20
EF/TY

WIDE24
G/W

 TOPMET®

SURFACE10 BC/UX

- B** slide cover
klosz B wsuwany
- C** click cover
klosz C klik
- C** lens cover
klosz C soczewka
- U**¹ U flexible mounting plate
uchwyt U sprężysty
- U**² cone U flexible mounting plate
uchwyt U sprężysty cone
- X**¹ X mounting plate
uchwyt X

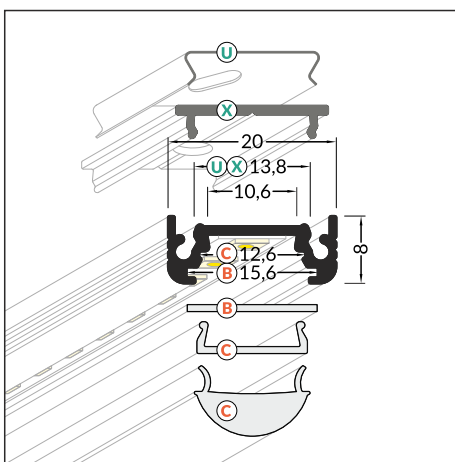
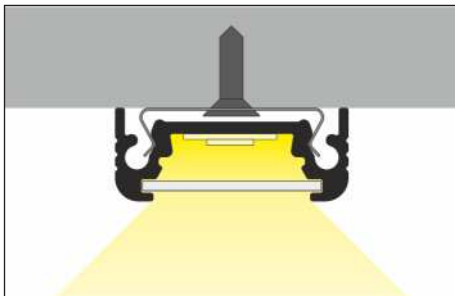
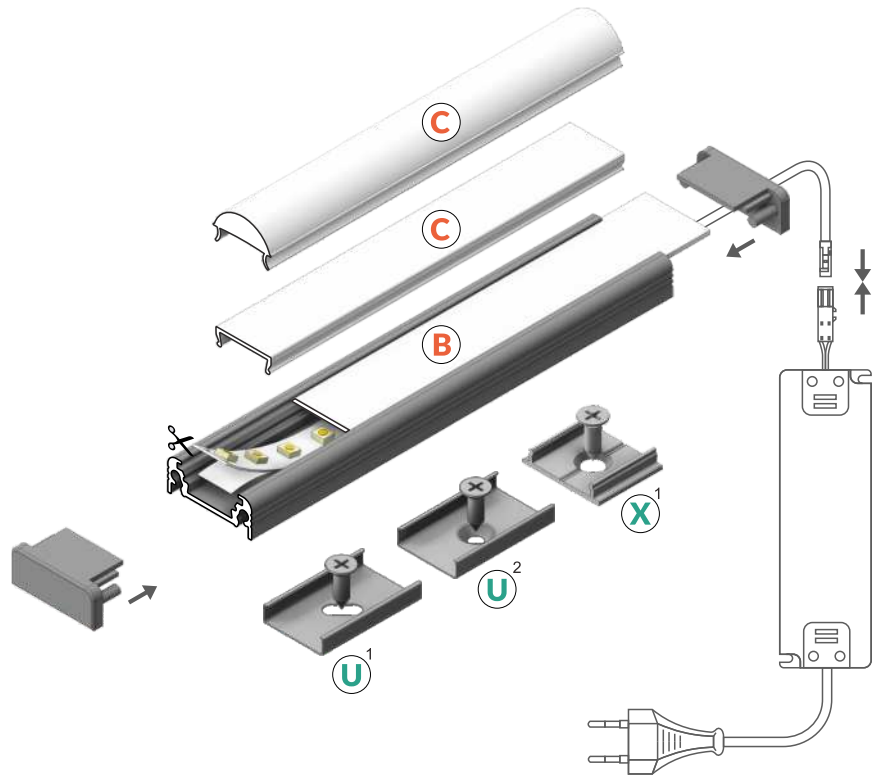

max 10 mm



surface
nawierzchniowy



white painted
biały malowany
77270001



anodized
anodowany
77270020



black anodized
czarny anodowany
77270021



raw aluminium
surowe aluminium
77270000

INDEX = 1 pc, length 2000 mm
package = 10 pcs
INDEKS = 1 szt., długość 2000 mm
opakowanie = 10 szt.

Available lengths / Dostępne długości
1000 mm, 2000 mm, 3000 mm, 4000 mm



COVERS / KLOSZE

B slide cover

colours: transparent, frosted, white
material: PC, PP, PP

klosz B wsuwany
kolory: transparentny, szron, mleczny
materiał: PC, PP, PP

C click cover

colours: transparent, white
material: PMMA

klosz C klik
kolory: transparentny, mleczny
materiał: PMMA

C click cover lens
colour: transparent
material: PC

klosz C klik soczewka
kolor: transparentny
materiał: PC



Note! Dimensions of the space to install LED source
Uwaga! Wymiary przestrzeni do zamontowania źródła LED

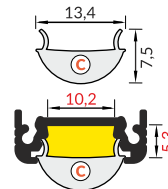
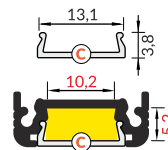
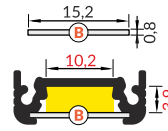

INDEX = 1 pc, length 2000 mm
package = 10 pcs
INDEKS = 1 szt., długość 2000 mm
opakowanie = 10 szt.

B transparent / B transparentny
76250016

B frosted / B szron
76250039

B white / B mleczny
76250038

C transparent / C transparentny
76330000

C white / C mleczny
76330038

C lens / C soczewka
76300000

MOUNTINGS / MOCOWANIA

U flexible mounting plate

colours: inox
material: stainless steel

uchwyt U sprężysty
kolory: inox
materiał: stal nierdzewna

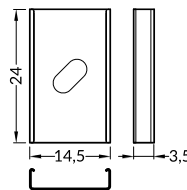
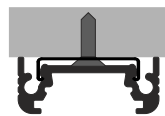

INDEX = 1 set
package of 10 sets = 20 pcs
INDEKS = 1 komplet
opakowanie zawiera 10 kpl = 20 szt.

U flexible mounting plate
uchwyt U sprężysty

inox
inox 76380000

cone U flexible mounting plate

colours: inox
material: stainless steel

uchwyt U sprężysty cone
kolory: inox
materiał: stal nierdzewna

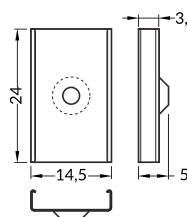
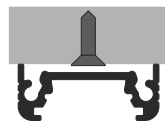

cone U flexible mounting plate
uchwyt U sprężysty cone

inox
inox 76620000

X mounting plate

colours: raw aluminium
material: aluminium

uchwyt X
kolory: surowe aluminium
materiał: aluminium

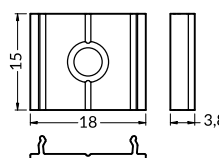
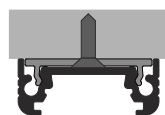

X mounting plate
uchwyt X

raw aluminium
surowe aluminium
76260000

SURFACE10 simple holder

material: zinc coated
uchwyt SURFACE10 prosty
materiał: stal ocynkowana

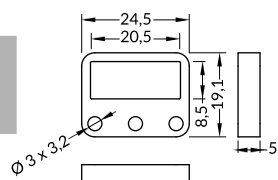
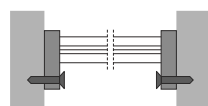

INDEX = 1 set = 2 pcs
INDEKS = 1 komplet = 2 szt.

simple holder
uchwyt prosty

zinc coated
stal ocynkowana
77370030



ENDINGS / ZAŚLEPKI

endings SURFACE10

colours: grey, black, white, silver
material: ABS

zaślepka SURFACE10

kolory: szary, czarny, biały, srebrny
materiał: ABS

endings SURFACE10 with hole
colours: grey, black, white, silver
material: ABS

zaślepka SURFACE10 z otworem

kolory: szary, czarny, biały, srebrny
materiał: ABS

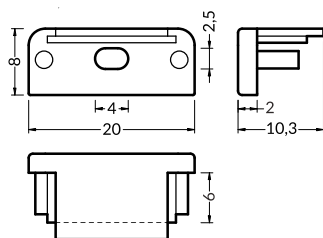

INDEX = 1 set
package of 10 sets = 20 pcs
INDEKS = 1 komplet, opakowanie
zawiera 10 kompletów = 20 szt.

 white białe	with hole z otworem 77520001	without hole bez otworu 77280001
 silver srebrne	with hole z otworem 77520040	without hole bez otworu 77280040
 black czarne	with hole z otworem 77520002	without hole bez otworu 77280002
 grey szare	with hole z otworem 77520022	without hole bez otworu 77280022

CONNECTORS / ŁĄCZNIKI

X connector

colours: inox
material: aluminium

łącznik X sprężysty
kolory: inox
materiał: aluminium

SURFACE10 L connector
colours: white, anodized, black
material: aluminium

łącznik L SURFACE10
kolory: biały, anodowany, czarny
materiał: aluminium

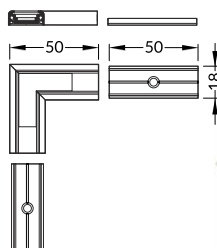
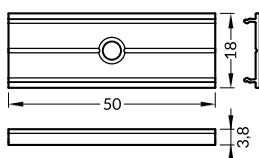

INDEX = 1 set
INDEKS = 1 komplet

X connector
łącznik X

 raw aluminium
surowe aluminium
76350000

L connector
łącznik L

 white painted
biały malowany
77410001

 anodized
anodowany
77410020

 black anodized
czarny anodowany
77410021



PL

Made in Poland
Wyprodukowane w Polsce



EU-registered industrial design
Wzory przemysłowe EU

TOPMET LIGHT Kłósowicz Wiśniewski i Wspólnik Sp. j. ADDRESS: Ostrowska 354, 61-312 Poznań, POLAND
tel. +48 61 87 27 500, fax. +48 61 87 27 518 biuro@topmet.pl, www.topmet.pl

The catalogue is not an offer under Polish Civil Code regulations. Colours of particular products may vary slightly from colours shown in pictures. The dimensions given are approximate and can not be a reason for complaint. TOPMET Company reserves the right to make technical changes.
Folder nie stanowi oferty w myśl przepisów Kodeksu Cywilnego. Aktualną ofertę firmy stanowi cennik. Kolory poszczególnych produktów mogą się nieznacznie różnić od kolorów prezentowanych na zdjęciach. Podane wymiary są wymiarami orientacyjnymi i nie mogą stanowić podstawy reklamacji. Firma TOPMET zastrzega sobie prawo do wprowadzania zmian technicznych.

brochure designer • proj. folderu: M. Kędziora, A. Szafran 11.2016. photo • fot. K. Samulska, A. Szafran, L. Wesołowski