

345 HV Series Panel Mount Enclosed Fuse Holders



Product Characteristics

| Compatible Fuses | For 3AB/3AG, 5x20mm Fuses |
|----------------------------|---|
| Description | Designed to eliminate the possibility of electrical shock, as defined in IEC standards 60127-6. The universal fuseholder body will accept 3AB, 3AG, and 5 x 20mm fuse sizes. |
| Electrical | Insulation Resistance: 10,000 megohm minimum at 500 VDC. Contact Resistance: Less than .005 ohm average at currents up to 1 ampere. Dielectric Strength: 4,000 volts minimum. |
| Mounting | Threaded styles withstand 15 in.-lb. mounting torque. Low profile and High profile panel thickness: .032" min./ .310" max. |
| Molded Parts | Body Material: Black glass-filled thermoplastic (UL 94V0). |
| Knob Material | Grey or black glass-filled thermoplastic (UL94 V-0) Hex Nut Material: Black glass-filled thermoplastic. |
| Knob | Fuse Extractor type with plated copper alloy insert. Plated copper alloy contact clips. Spring loaded, locking mechanism provides an anti-tease feature and will not vibrate loose. |
| Terminals | Plated cooper alloy, A-187; dual purpose terminal accepts wire for soldering or a Quick-Connect receptacle. |
| Ambient Temperature | -40°C to +85°C. |
| Hardware | Threaded style fuseholders are supplied with a thermoplastic hex nut unassembled. |

* Please refer to Fuseology section for information on proper fuseholder re-rating.

Additional Information



Datasheet



Resources



Samples

Agency Approval

| Agency | Agency File Number | 3AG/AB | 5x20mm |
|--------|--------------------|-----------|-----------|
| | E14721 | 20A, 600V | 20A, 600V |
| | 7316 | 20A, 600V | 20A, 600V |

Dimensions

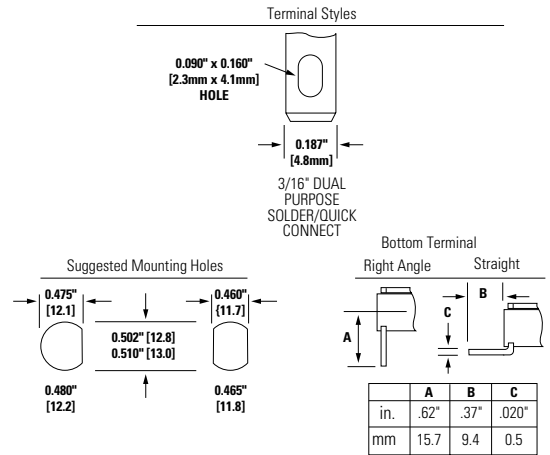
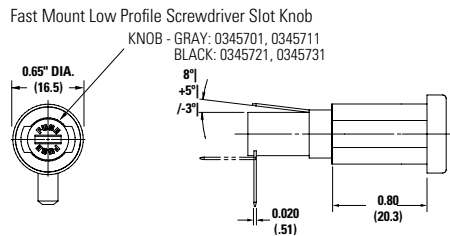
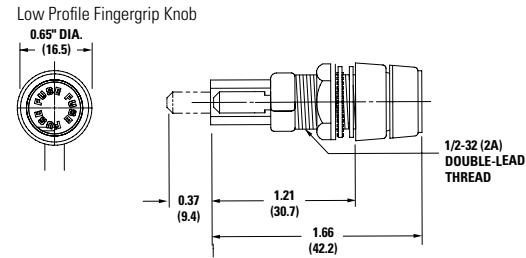
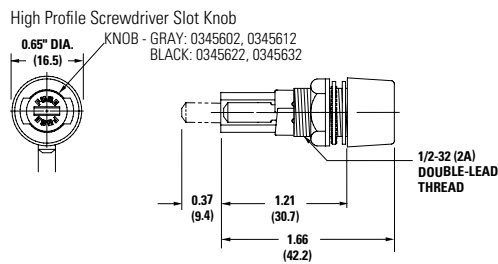
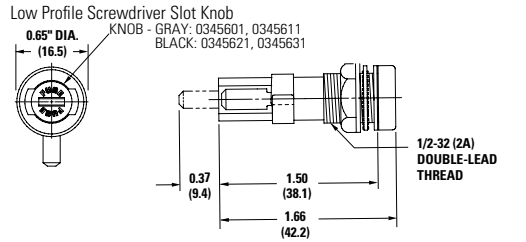

Push-On Type Retaining Nut for Quick Mount Fuseholder

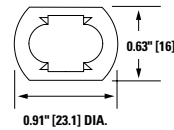

Plastic Hex Nut with Flange

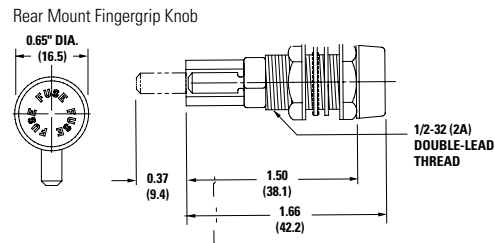
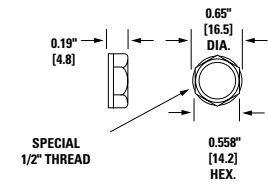

Part Numbering System

| Part Number | | Knob Type | Low Profile | High Profile | Front Mount | Rear Mount | Rt. Angle Terminal | Straight Terminal | Packing |
|-------------|-----------|------------------|-------------|--------------|-------------|------------|--------------------|-------------------|-------------------|
| (3AG/AB) | 5x20mm | | | | | | | | |
| 03450601H | 03450621H | Screwdriver Slot | X | - | X | - | X | - | Bulk (100 pieces) |
| 03450602H | 03450622H | Screwdriver Slot | - | X | X | - | X | - | Bulk (100 pieces) |
| 03450603H | 03450623H | Finger Grip | - | X | X | - | X | - | Bulk (100 pieces) |
| 03450611H | 03450631H | Screwdriver Slot | X | - | X | - | - | X | Bulk (100 pieces) |
| 03450612H | 03450632H | Screwdriver Slot | - | X | X | - | - | X | Bulk (100 pieces) |
| 03450613H | 03450633H | Finger Grip | - | X | X | - | - | X | Bulk (100 pieces) |
| 03450701H | -- | Screwdriver Slot | X | - | X | - | X | - | Bulk (100 pieces) |
| 03450711H | -- | Screwdriver Slot | X | - | X | - | - | X | Bulk (100 pieces) |
| 03450903H | 03450923H | Finger Grip | - | X | - | X | X | - | Bulk (100 pieces) |
| 03450913H | 03450933H | Finger Grip | - | X | - | X | - | X | Bulk (100 pieces) |



345 HV Series Shock Safe Circuit Board Mount Enclosed Fuse Holders     



Product Characteristics

| | |
|------------------------------|---|
| Compatible Fuse Types | 3AG 3AB 5x20mm |
| Description | Similar to our Shock-Safe panel mount fuseholders, this series is designed per IEC Standards 60127-6. Two different knob styles available are available for use with 3AG and 3AB (1/4" x 1 1/4") or 5 x 20mm fuses. |
| Electrical | Insulation Resistance: 10,000 megohm minimum at 500 VDC. Contact Resistance: Less than .005 ohm average at a current of one ampere. |
| Dielectric Strength | 4000 volts minimum. Mounting: Intended for soldering to printed circuit boards. |
| Molded Parts | Body Material: Black glass-filled thermoplastic (UL 94V0). |
| Knob | Screwdriver slot, fuse extractor type with nickel-plated, copper alloy insert. Spring-loaded, bayonet style. Knob Material: Grey or Black glass-filled thermoplastic (UL94 V-0) |
| Terminals | Brass. Tin-plated. |
| Ambient Temperature | -40°C to +85°C. |

Agency Approvals

| Agency | Agency File Number |
|---|--------------------|
|  | E14721 |
|  | 7316 |
|  | 133923 |

* Please refer to Fuseology section for information on proper fuseholder re-rating.

Ordering Information

| Ordering Part Number | Catalog Number | Fuse Size | Packing |
|----------------------|----------------|---------------------|-------------------|
| 03450101H | 345 101 | 1/4" x 1 1/4" Fuses | Bulk (100 pieces) |
| 03450121H | 345 121 | 5 x 20mm Fuses | Bulk (100 pieces) |

Body only: 03450101HX010
Knob only: 03450101HX020 (1/4" x 1 1/4") Grey; 03450121HX020 (5 x 20mm) Black.

Dimensions

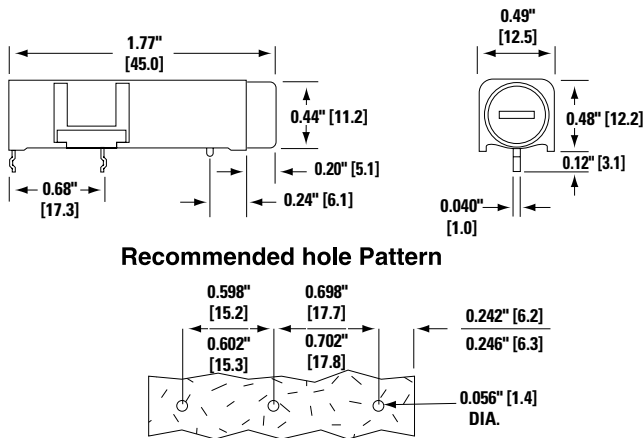

Mouser Electronics

Authorized Distributor

Click to View Pricing, Inventory, Delivery & Lifecycle Information:

Littelfuse:

[345923](#) [345603](#) [345601-020](#) [345602](#) [345621](#) [345621-020](#) [345623-020](#) [571008](#) [03450601ZX010](#) [345101](#)
[345121](#) [345121-02](#) [345601](#) [345613](#) [345933](#) [571007P](#) [345933A](#) [03450623HX020](#) [03450632X](#) [03450613H](#)
[03450612X](#) [03450903X](#) [03450101X](#) [03450701ZX010](#) [03450603HX020](#) [03450612ZX010](#) [03450913X](#) [03450933X](#)
[03450923X](#) [03450711ZX010](#) [03450913H](#) [03450612H](#) [03450621H](#) [03450623X](#) [03450613ZX010](#) [03450711X](#)
[03450611H](#) [03450121X](#) [03450913ZX010](#) [03450613X](#) [03450631X](#) [03450633H](#) [03450711H](#) [03450602ZX010](#)
[03450603H](#) [03450611X](#) [03450603X](#) [03450601X](#) [03450611ZX010](#) [03450622X](#) [03450923H](#) [03450602H](#) [03450933H](#)
[03450623H](#) [03450101H](#) [03450601HX020](#) [03450631H](#) [03450633X](#) [03450601H](#) [03450622H](#) [03450121H](#)
[03450621X](#) [03450701H](#) [03450903H](#) [345611](#) [03450701X](#) [03450903ZX010](#) [03450621HX020](#) [345903](#) [03450632H](#)
[03450603HX040](#) [03450613HX040](#) [03450612HX040](#) [03450701HX040](#)