

Bridge Rectifier

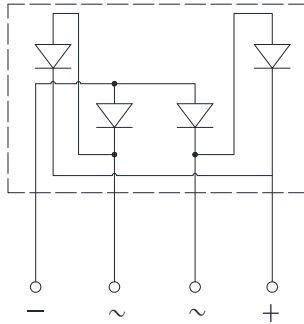
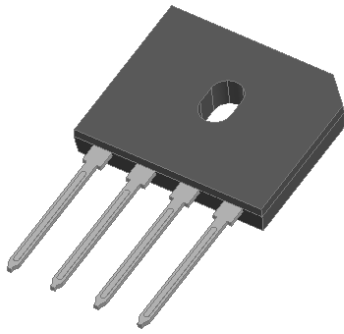

Features

- UL recognition, file #E230084
- Ideal for printed circuit boards
- High surge current capability
- Solder dip 275 °C max. 7 s, per JESD 22-B106

Typical Applications

General purpose use in AC/DC bridge full wave rectification for monitor, TV, printer, power supply, switching mode power supply, adapter, audio equipment, and home appliances applications.

Mechanical Data

- **Package:** GBU
Molding compound meets UL 94 V-0 flammability rating, RoHS-compliant
- **Terminals:** Tin plated leads, solderable per J-STD-002 and JESD22-B102
- **Polarity:** As marked on body

■ Maximum Ratings ($T_a=25^\circ\text{C}$ Unless otherwise specified)

PARAMETER	SYMBOL	UNIT	GBU6005	GBU601	GBU602	GBU604	GBU606	GBU608	GBU610
Device marking code			GBU6005	GBU601	GBU602	GBU604	GBU606	GBU608	GBU610
Repetitive peak reverse voltage	VRRM	V	50	100	200	400	600	800	1000
Average rectified output current @60Hz sine wave, R-load	With heatsink $T_c=110^\circ\text{C}$	IO	A	6					
	Without heatsink $T_a=25^\circ\text{C}$			2.8					
Surge(non-repetitive)forward current @60Hz half sine wave, 1 cycle, $T_j=25^\circ\text{C}$	IFSM	A	135						
Current squared time @1ms≤t≤8.3ms $T_j=25^\circ\text{C}$, Rating of per diode	I^2t	A ² s	75						
Storage temperature	Tstg	°C	-55 ~+150						
Junction temperature	Tj	°C	-55 ~+150						
Dielectric strength @ terminals to case, AC 1 minute	Vdis	KV	2						
Mounting torque @recommend torque: 5kg·cm	Tor	kg·cm	8						

■ Electrical Characteristics ($T_a=25^\circ\text{C}$ Unless otherwise specified)

PARAMETER	SYMBOL	UNIT	TEST CONDITIONS	GBU6005	GBU601	GBU602	GBU604	GBU606	GBU608	GBU610
Maximum instantaneous forward voltage drop per diode	V _F	V	I _{FM} =3A	1.05						
Maximum DC reverse current at rated DC blocking voltage per diode	I _R RM	μA	V _{RM} =V _R RM	10						



GBU6005 THRU GBU610

■ Thermal Characteristics ($T_a=25^\circ\text{C}$ Unless otherwise specified)

PARAMETER		SYMBOL	UNIT	GBU6005	GBU601	GBU602	GBU604	GBU606	GBU608	GBU610
Thermal Resistance	Between junction and ambient, Without heatsink	$R_{\theta J-A}$	$^\circ\text{C}/\text{W}$	26						
	Between junction and case, With heatsink	$R_{\theta J-C}$		3.4						

■ Ordering Information (Example)

PREFERED P/N	PACKING CODE	UNIT WEIGHT(g)	MINIIMUM PACKAGE(pcs)	INNER BOX QUANTITY(pcs)	OUTER CARTON QUANTITY(pcs)	DELIVERY MODE
GBU6005 THRU GBU610	B1	Approximate 3.96	20	1000	2000	TUBE
GBU6005 THRU GBU610	A1	Approximate 3.96	250	250	4000	BOX

■ Characteristics (Typical)

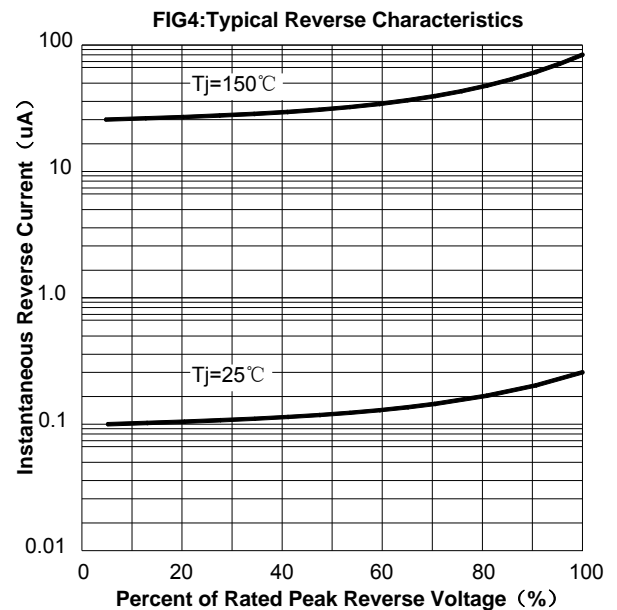
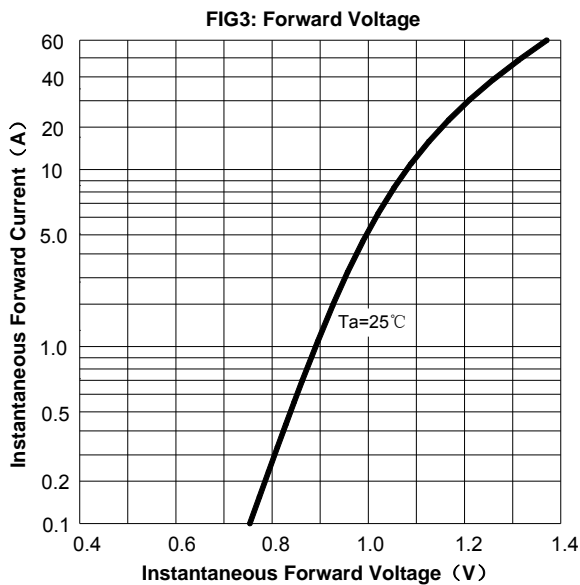
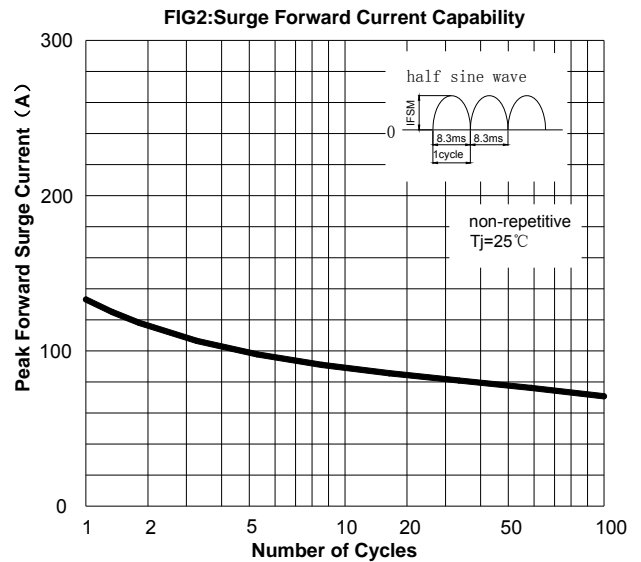
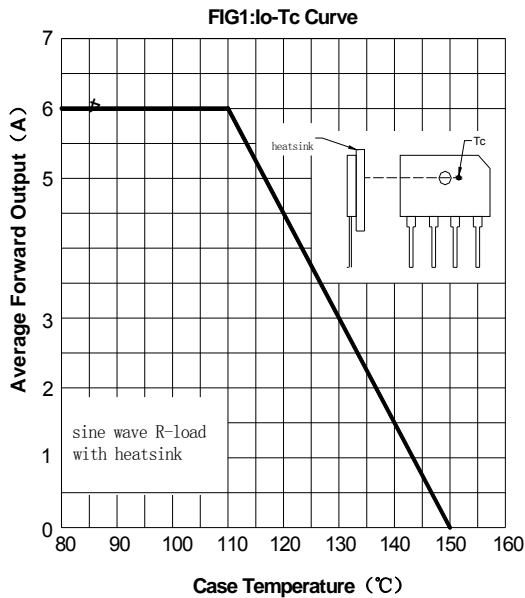



GBU6005 THRU GBU610

■ Outline Dimensions

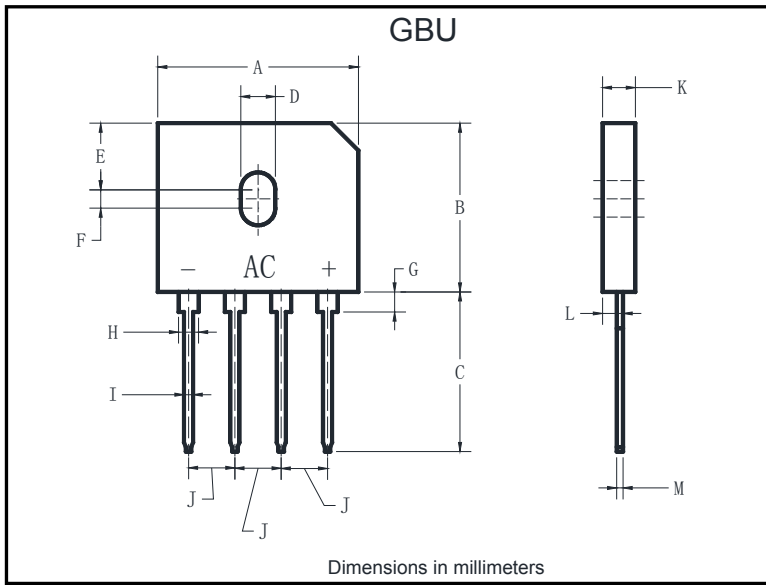

GBU		
Dim	Min	Max
A	21.80	22.30
B	18.30	18.80
C	17.50	18.00
D	3.50	4.10
E	7.40	7.90
F	1.65	2.16
G	1.91	2.54
H	2.06	2.54
I	1.02	1.27
J	4.83	5.33
K	3.30	3.56
L	2.40	2.66
M	0.46	0.56



GBU6005 THRU GBU610

Disclaimer

The information presented in this document is for reference only. Yangzhou Yangjie Electronic Technology Co., Ltd. reserves the right to make changes without notice for the specification of the products displayed herein to improve reliability, function or design or otherwise.

The product listed herein is designed to be used with ordinary electronic equipment or devices, and not designed to be used with equipment or devices which require high level of reliability and the malfunction of which would directly endanger human life (such as medical instruments, transportation equipment, aerospace machinery, nuclear-reactor controllers, fuel controllers and other safety devices), Yangjie or anyone on its behalf, assumes no responsibility or liability for any damages resulting from such improper use of sale.

This publication supersedes & replaces all information previously supplied. For additional information, please visit our website [http:// www.21yangjie.com](http://www.21yangjie.com) , or consult your nearest Yangjie's sales office for further assistance.