

GENERAL FEATURES

- $V_{DS} = 200V$
- $I_D = 1.0 A$ @ $V_{GS} = 10V$
- $R_{DS(ON)} \leq 1.35\Omega$ @ $V_{GS} = 10V$
- SOT-223 package.

Application

- Power Supply
- PFC
- LED TV

Package and Pin Configuration

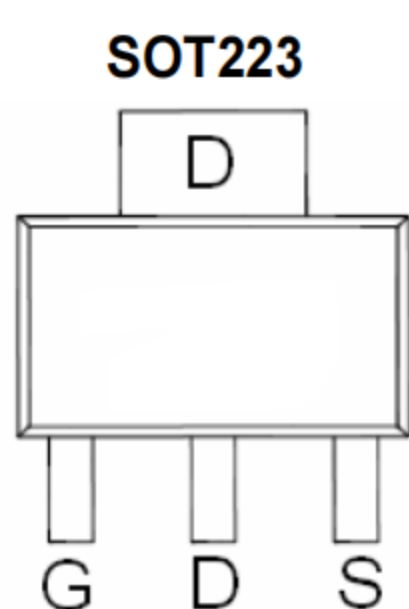

Circuit diagram

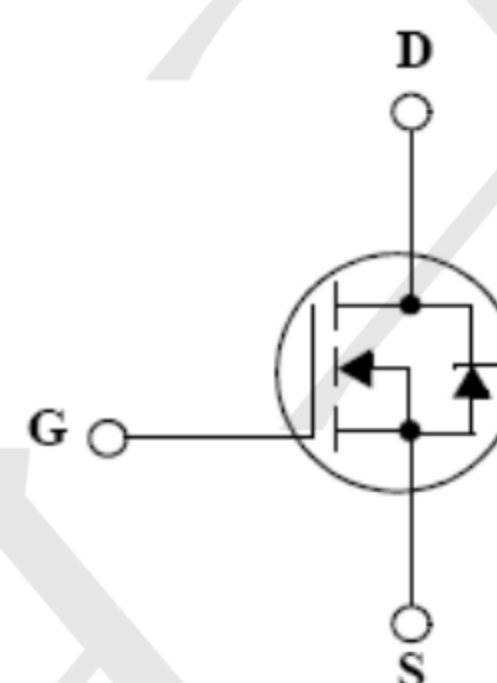

Marking:

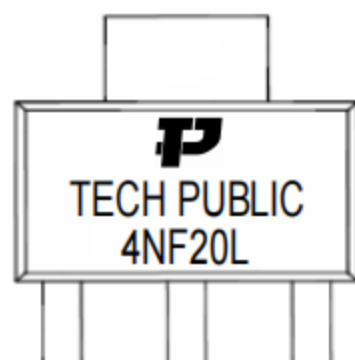

ABSOLUTE MAXIMUM RATINGS $T_A = 25^\circ C$ unless otherwise noted

Characteristics	Symbol	Rating	Unit
Drain-Source Voltage	V_{DSS}	200	V
Gate-Source Voltage	V_{GSS}	± 20	V
Continuous Drain Current	I_D	$T_C = 25^\circ C$	1.0
		$T_C = 100^\circ C$	0.54
Pulsed Drain Current ⁽¹⁾	I_{DM}	3.4	A
Power Dissipation	P_D	$T_C = 25^\circ C$	2.1
		Derate above $25^\circ C$	0.017
Peak Diode Recovery dv/dt ⁽³⁾	Dv/dt	5.5	V/ns
Repetitive Pulse Avalanche Energy ⁽⁴⁾	E_{AR}	0.21	mJ
Avalanche current ⁽¹⁾	I_{AR}	0.85	A
Single Pulse Avalanche Energy ⁽⁴⁾	E_{AS}	52	mJ
Junction and Storage Temperature Range	T_J, T_{stg}	-55~150	$^\circ C$

Thermal Characteristics

Characteristics	Symbol	Rating	Unit
Thermal Resistance, Junction-to-Ambient *	$R_{\theta JA}$	60	$^\circ C/W$

Electrical Characteristics $T_A = 25^\circ\text{C}$ unless otherwise noted

Characteristics	Symbol	Test Condition	Min	Typ	Max	Unit
Static Characteristics						
Drain-Source Breakdown Voltage	BV_{DSS}	$I_D = 250\mu\text{A}, V_{GS} = 0\text{V}$	200	-	-	V
Gate Threshold Voltage	$V_{GS(th)}$	$V_{DS} = V_{GS}, I_D = 250\mu\text{A}$	1.0	1.6	2.0	
Drain Cut-Off Current	I_{DSS}	$V_{DS} = 200\text{V}, V_{GS} = 0\text{V}$	-	-	1	μA
Gate Leakage Current	I_{GSS}	$V_{GS} = \pm 20\text{V}, V_{DS} = 0\text{V}$	-	-	100	nA
Drain-Source ON Resistance	$R_{DS(ON)}$	$V_{GS} = 10\text{V}, I_D = 0.425\text{A}$	-	0.9	1.35	Ω
Forward Transconductance	g_{fs}	$V_{DS} = 30\text{V}, I_D = 0.425\text{A}$	-	1.3	-	S
Dynamic Characteristics						
Total Gate Charge	Q_g	$V_{DS} = 160\text{V}, I_D = 3.8\text{A}, V_{GS} = 5\text{V}$	-	3.2	-	nC
Gate-Source Charge	Q_{gs}		-	0.64	-	
Gate-Drain Charge	Q_{gd}		-	1.6	-	
Input Capacitance	C_{iss}	$V_{DS} = 25\text{V}, V_{GS} = 0\text{V}, f = 1.0\text{MHz}$	-	148	-	pF
Reverse Transfer Capacitance	C_{rss}		-	11.3	-	
Output Capacitance	C_{oss}		-	42.7	-	
Turn-On Delay Time	$t_{d(on)}$	$V_{GS} = 5\text{V}, V_{DS} = 100\text{V}, I_D = 3.8\text{A}, R_G = 25\Omega$	-	6	-	ns
Rise Time	t_r		-	38	-	
Turn-Off Delay Time	$t_{d(off)}$		-	11	-	
Fall Time	t_f		-	13	-	
Drain-Source Body Diode Characteristics						
Maximum Continuous Drain to Source Diode Forward Current	I_S		-	1.0	-	A
Source-Drain Diode Forward Voltage	V_{SD}	$I_S = 0.85\text{A}, V_{GS} = 0\text{V}$	-	-	1.5	V
Body Diode Reverse Recovery Time	t_{rr}	$I_F = 3.8\text{A}, di/dt = 100\text{A}/\mu\text{s}^{(3)}$	-	90	-	ns
Body Diode Reverse Recovery Charge	Q_{rr}		-	0.24	-	μC

Typical Electrical and Thermal Characteristics

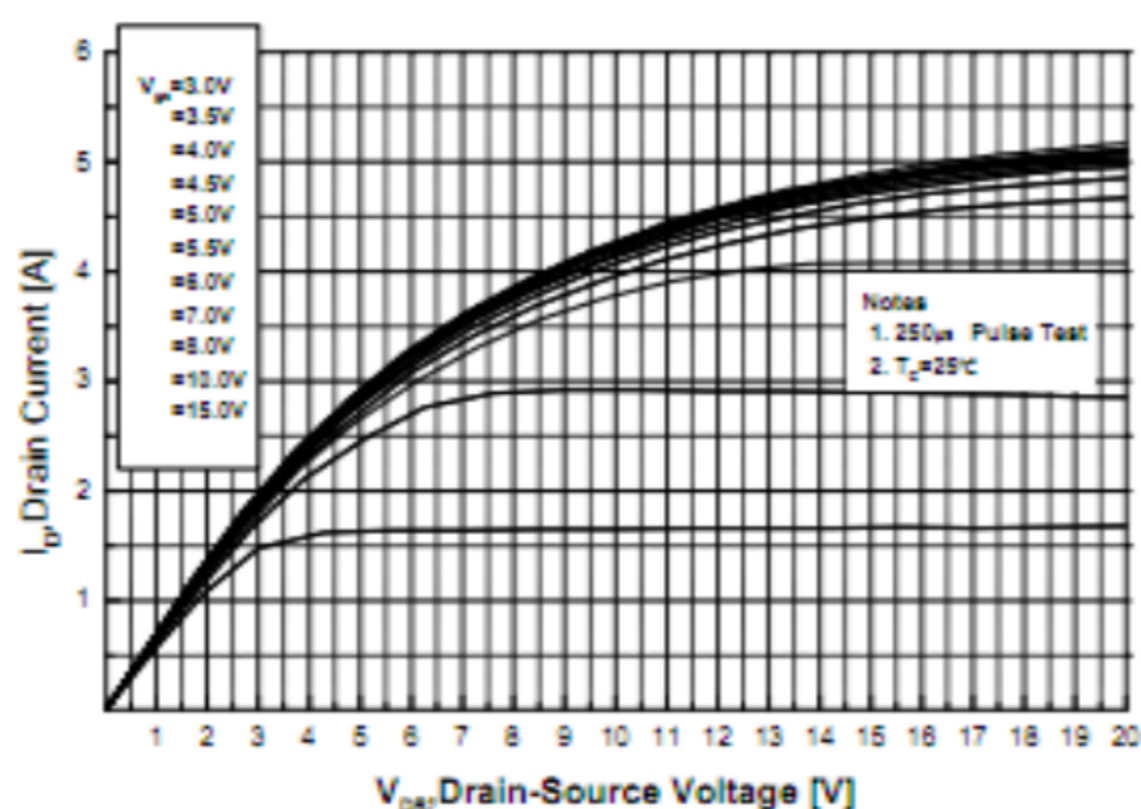

Fig.1 On-Region Characteristics

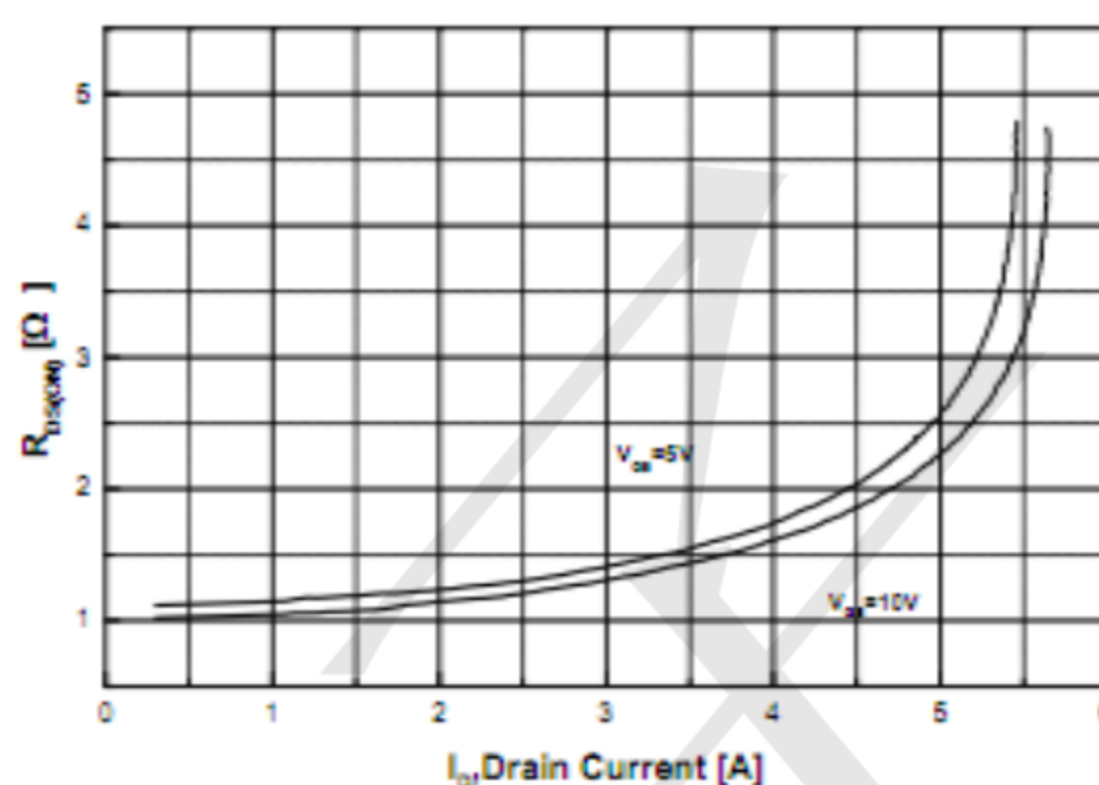

Fig.2 On-Resistance Variation with Drain Current and Gate Voltage

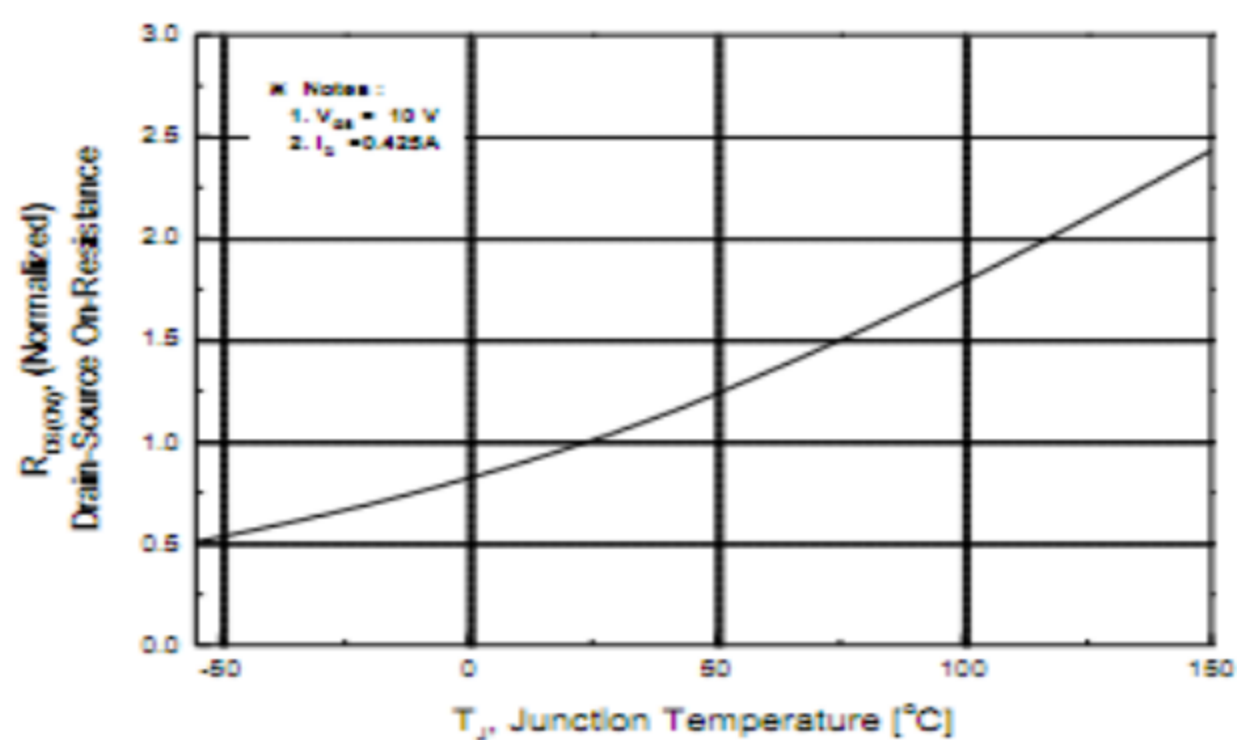

Fig.3 On-Resistance Variation with Temperature

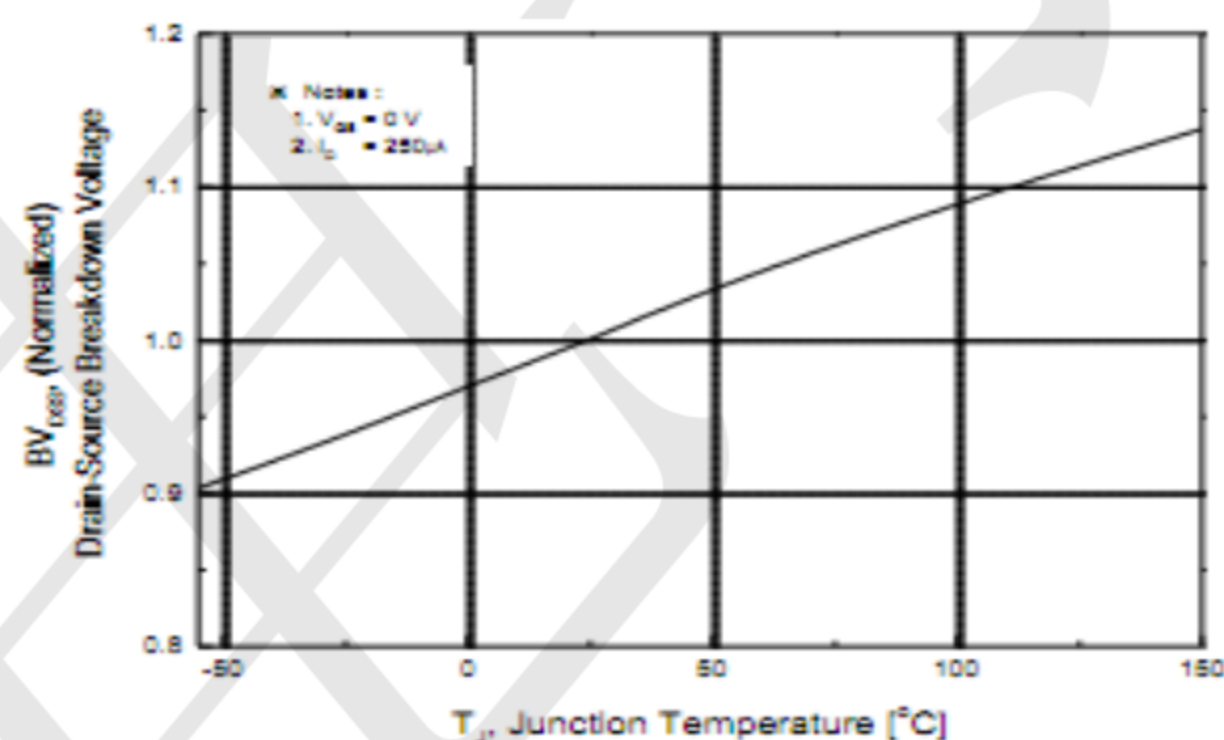

Fig.4 Breakdown Voltage Variation vs. Temperature

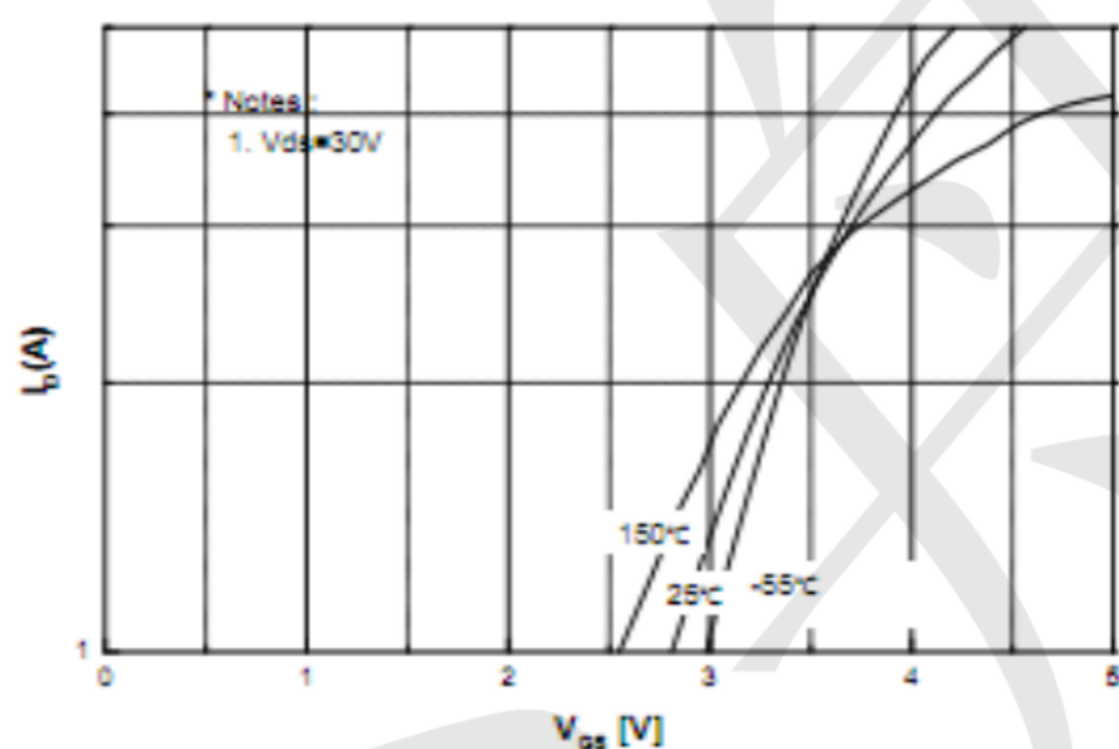

Fig.5 Transfer Characteristics

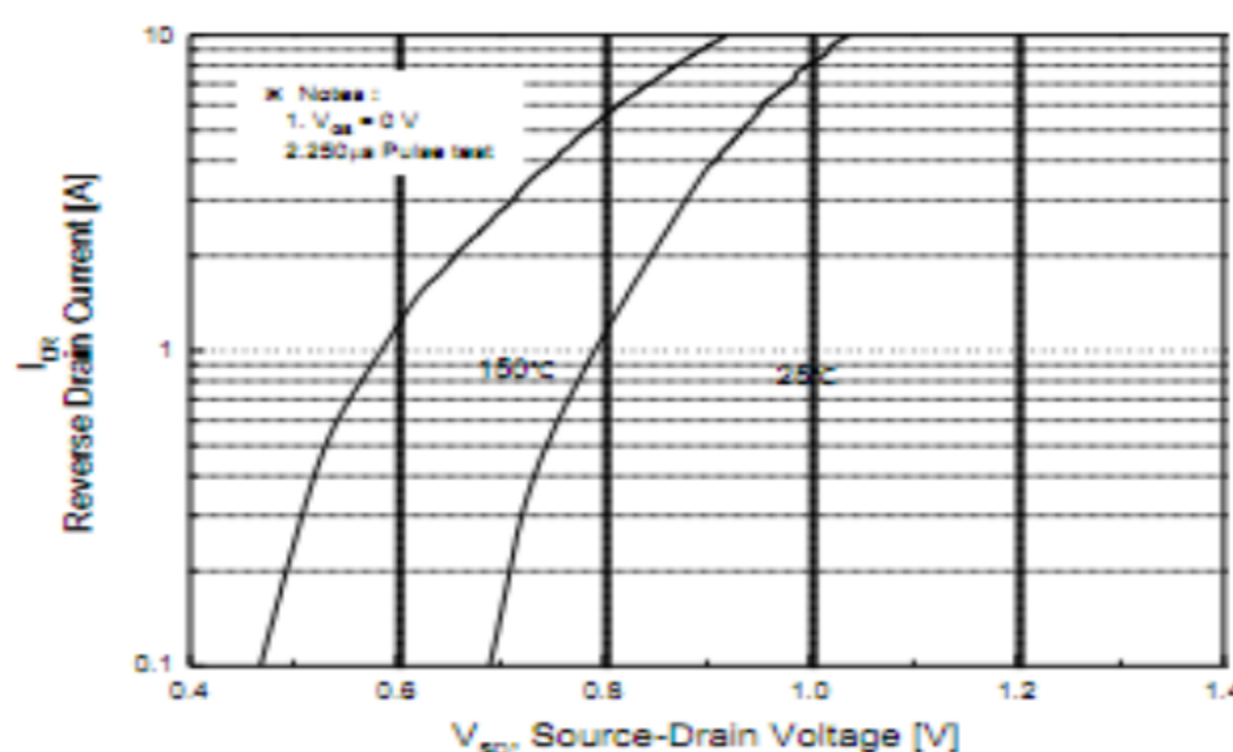

Fig.6 Body Diode Forward Voltage Variation with Source Current and Temperature

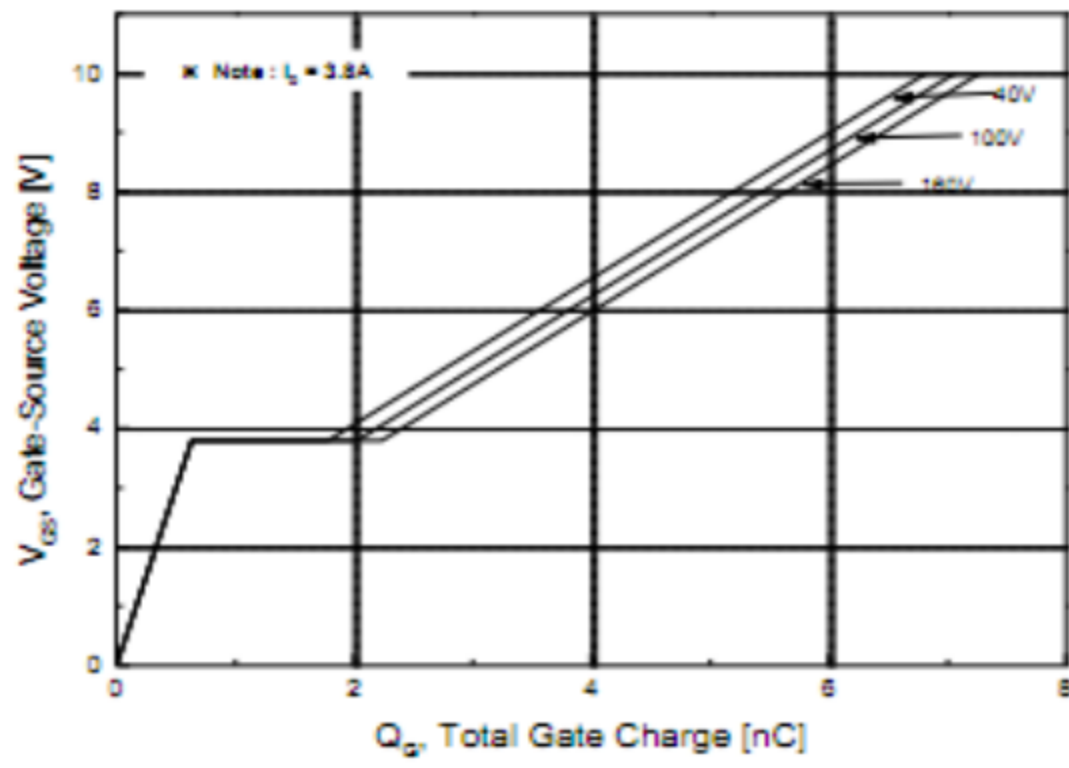

Fig.7 Gate Charge Characteristics

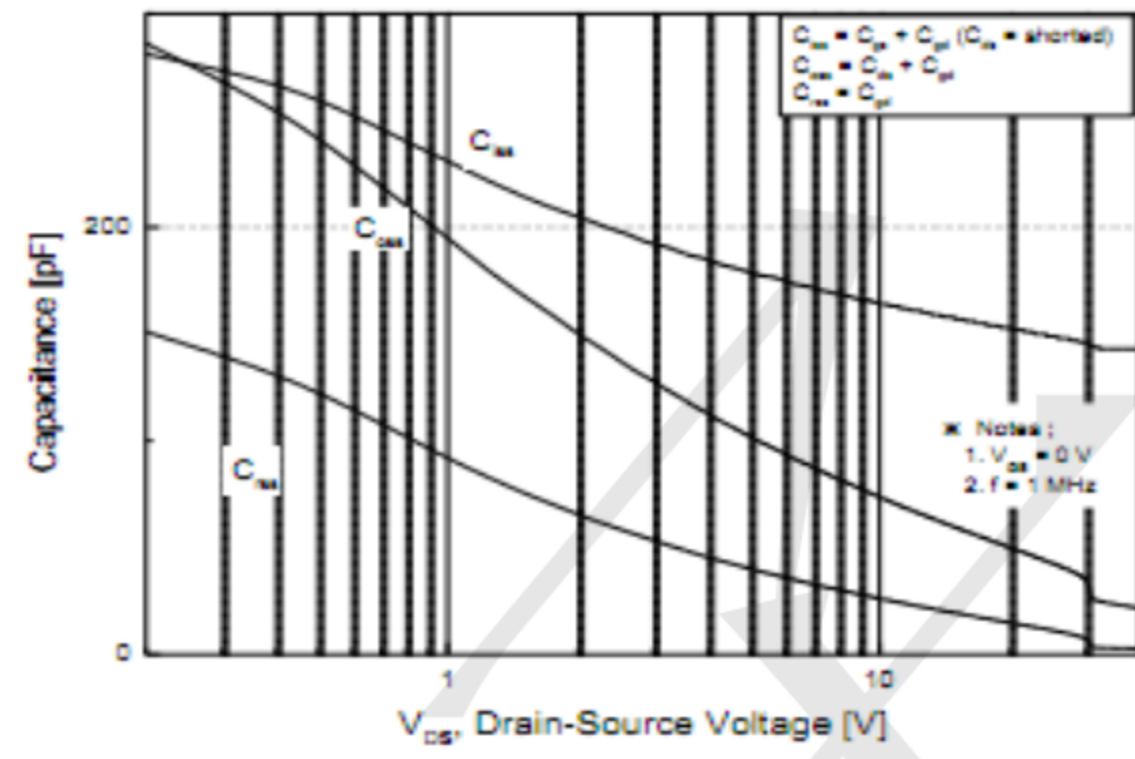

Fig.8 Capacitance Characteristics

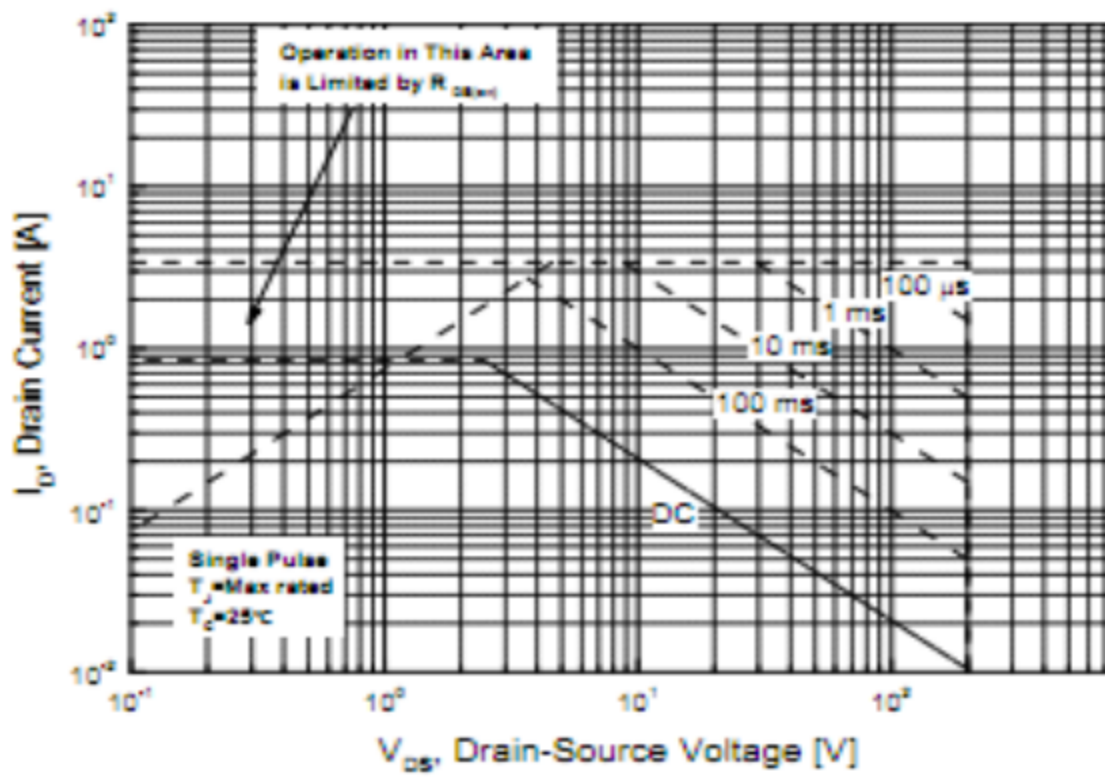

Fig.9 Maximum Safe Operating Area

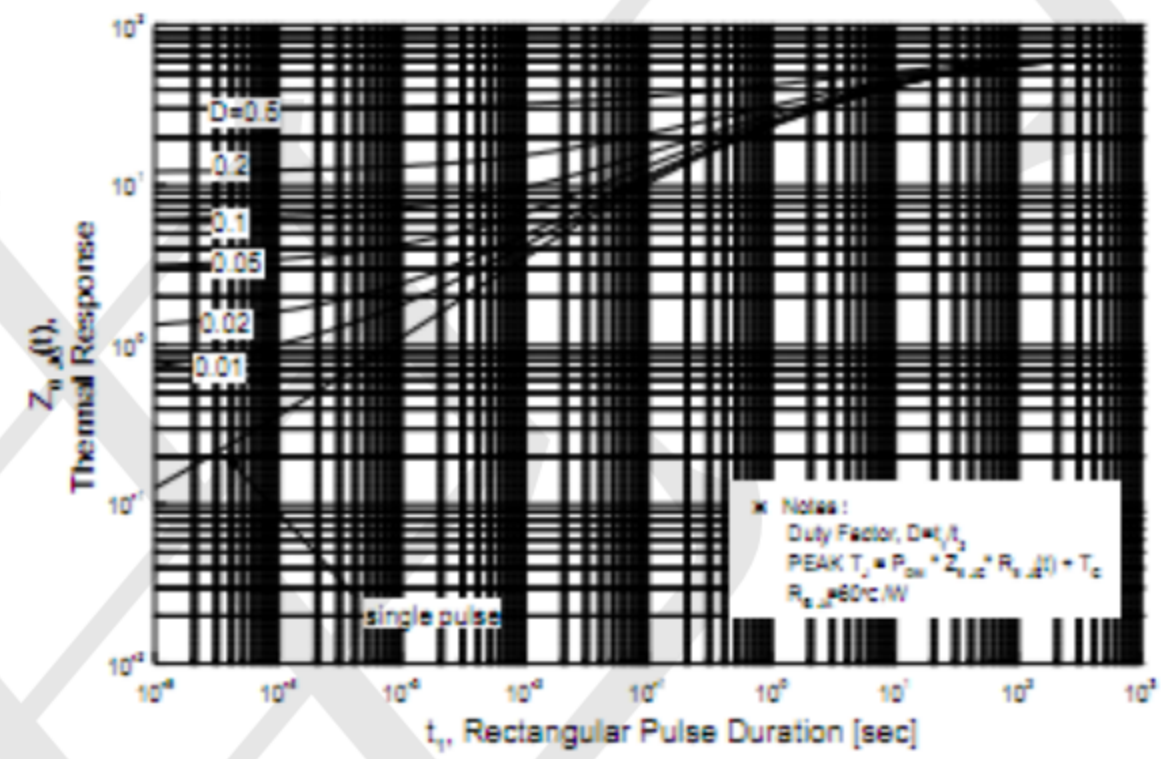

Fig.10 Transient Thermal Response Curve

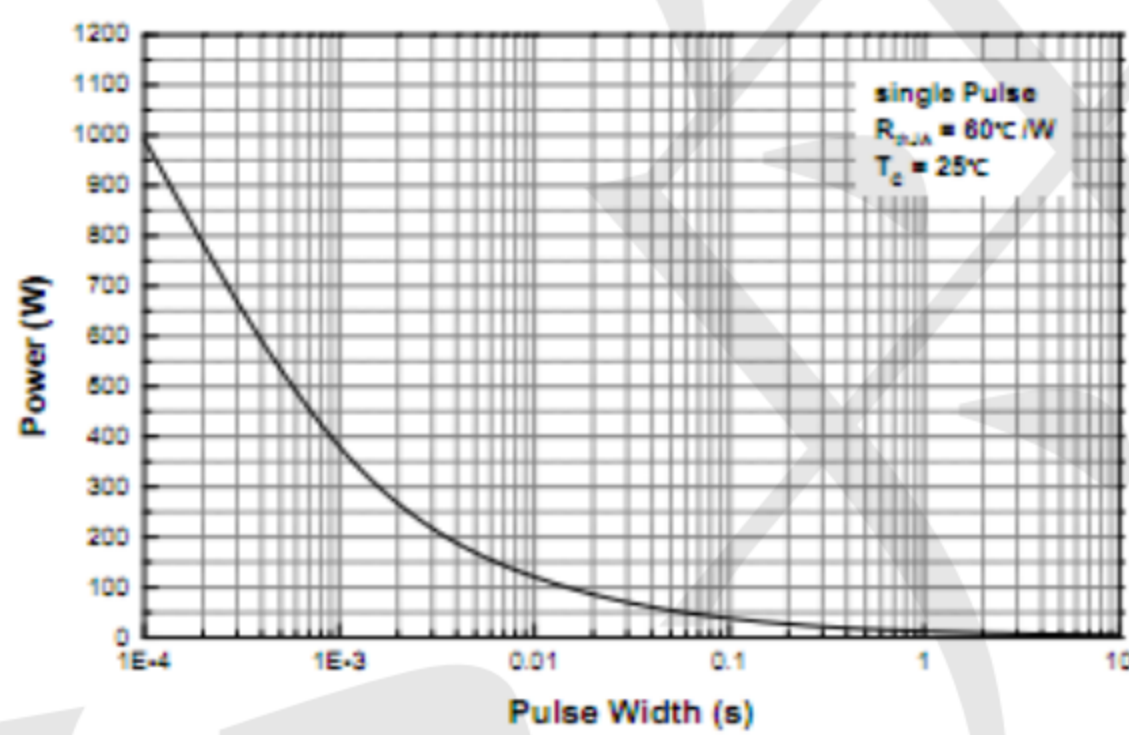

Fig.11 Single Pulse Maximum Power Dissipation

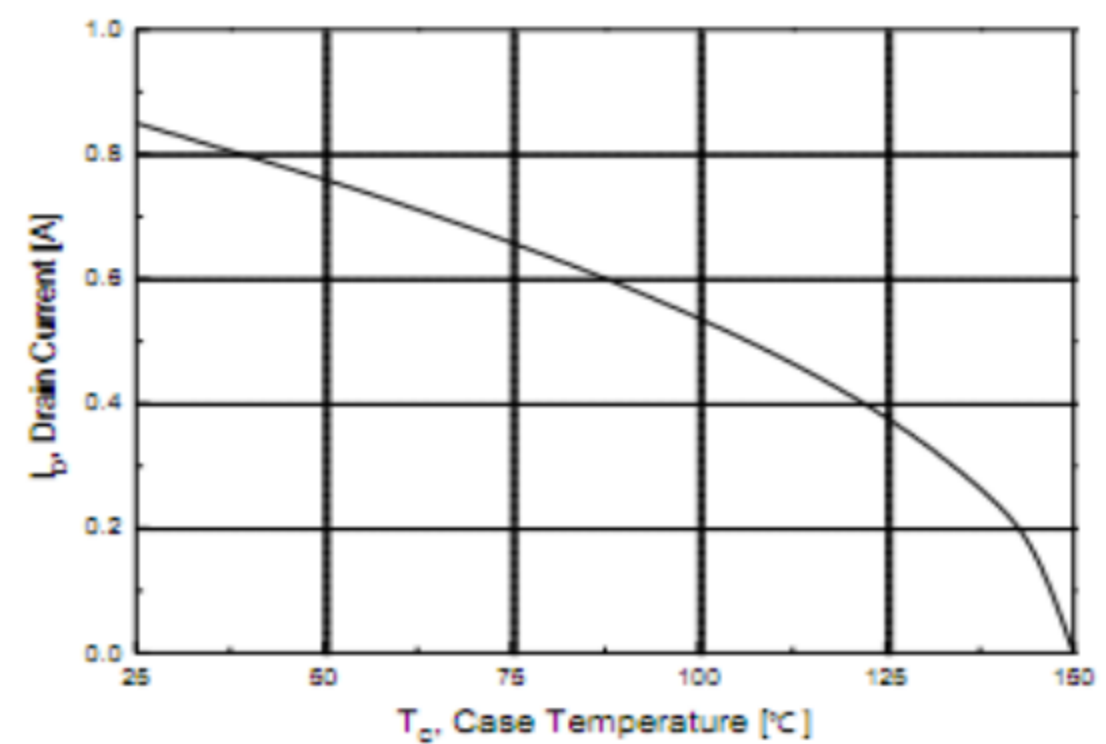
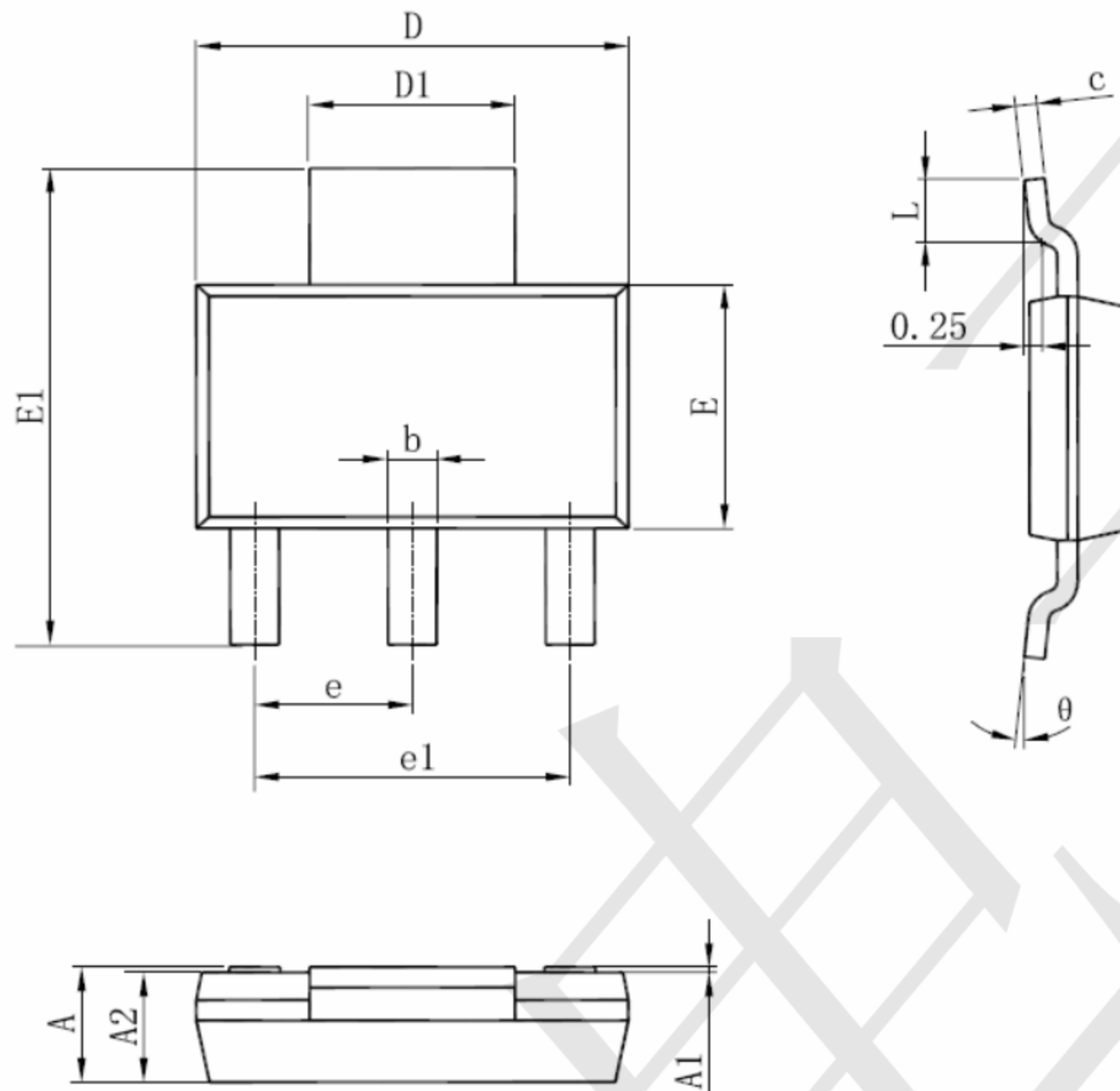

Fig.12 Maximum Drain Current vs. Case Temperature



SOT-223 Package Information



Symbol	Dimensions In Millimeters		Dimensions In Inches	
	Min	Max	Min	Max
A	1.520	1.800	0.060	0.071
A1	0.000	0.100	0.000	0.004
A2	1.500	1.700	0.059	0.067
b	0.660	0.820	0.026	0.032
c	0.250	0.350	0.010	0.014
D	6.200	6.400	0.244	0.252
D1	2.900	3.100	0.114	0.122
E	3.300	3.700	0.130	0.146
E1	6.830	7.070	0.269	0.278
e	2.300(BSC)		0.091(BSC)	
e1	4.500	4.700	0.177	0.185
L	0.900	1.150	0.035	0.045
θ	0°	10°	0°	10°