

This drawing is copyright. Information contained thereon is supplied in confidence and must not be used for any other purpose than which it was supplied, or be reproduced without written permission of the owners.

Diese Zeichnung ist unser geistiges Eigentum und darf ohne unsere ausdrückliche Einwilligung weder kopiert, vervielfältigt, noch Drittpersonen oder Konkurrenzfirmen zugänglich gemacht werden.

H+S 701 448.05

type : 11 QMA-50-3-1

	date	sign
drawn	21.03.02	4952/srm
checked	25.03.02	4728/GRU
approved	25.03.02	4728/GRU

cable shortening dimension

scale 2,5:1

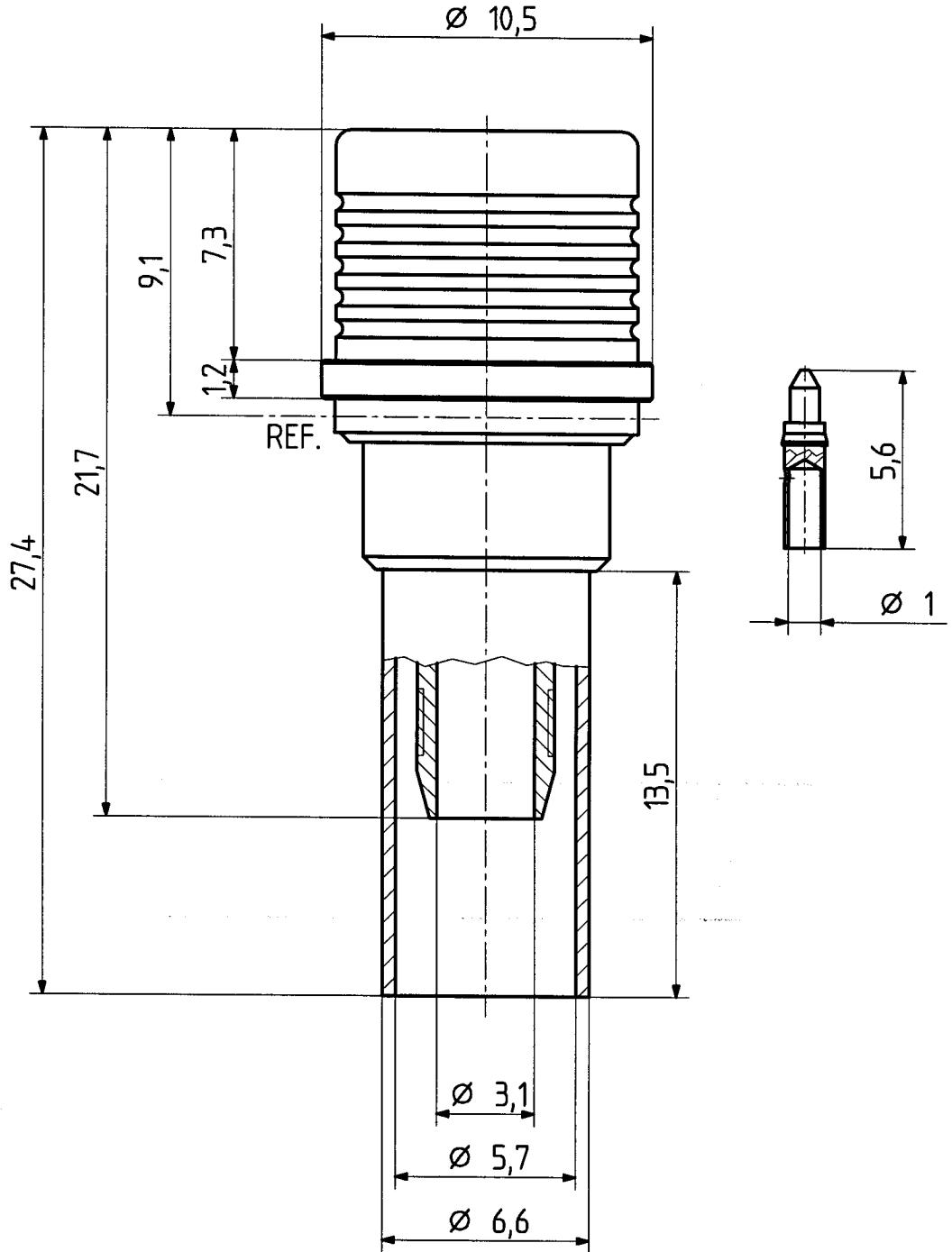
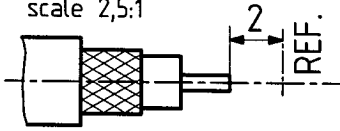

scale

5 : 1



HUBER + SUHNER
CH-ITC-RBS-CON

dimensions in mm

drawing number

4.13.33038

OZ drawing : OZ.

Index

C