

Features

- Superior circuit protection
- Overcurrent and overvoltage protection
- Blocks surges up to rated limits
- High-speed performance
- Small SMT package
- Agency listing: [®]

Applications

- Voice / VDSL cards
- Protection modules and dongles
- Process control equipment
- Test and measurement equipment
- General electronics

TBU-CA Series - TBU[®] High-Speed Protectors

General Information

The TBU-CA Series of Bourns[®] TBU[®] products are low capacitance single bidirectional high-speed protection components, constructed using MOSFET semiconductor technology, and designed to protect against faults caused by short circuits, AC power cross, induction and lightning surges.

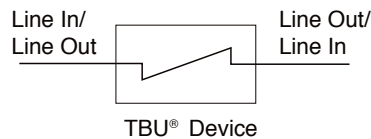

Agency Listing

Description	
UL	File Number: E315805

The TBU[®] high-speed protector placed in the system circuit will monitor the current with the MOSFET detection circuit triggering to provide an effective barrier behind which sensitive electronics will not be exposed to large voltages or currents during surge events. The TBU[®] device is provided in a surface mount DFN package and meets industry standard requirements such as RoHS and Pb Free solder reflow profiles.

Absolute Maximum Ratings (@ T_A = 25 °C Unless Otherwise Noted)

Symbol	Parameter	Part Number	Value	Unit
V _{imp}	Peak impulse voltage withstand with duration less than 10 ms	TBU-CA025-xxx-WH	250	V
		TBU-CA040-xxx-WH	400	
		TBU-CA050-xxx-WH	500	
		TBU-CA065-xxx-WH	650	
		TBU-CA085-xxx-WH	850	
V _{rms}	Continuous A.C. RMS voltage	TBU-CA025-xxx-WH	100	V
		TBU-CA040-xxx-WH	200	
		TBU-CA050-xxx-WH	250	
		TBU-CA065-xxx-WH	300	
		TBU-CA085-xxx-WH	425	
T _{op}	Operating temperature range		-55 to +125	°C
T _{stg}	Storage temperature range		-65 to +150	°C
T _{jmax}	Maximum Junction Temperature		+125	°C
ESD	HBM ESD protection per IEC 61000-4-2		±2	kV

BOURNS[®]

Asia-Pacific: Tel: +886-2 2562-4117 • Fax: +886-2 2562-4116

EMEA: Tel: +36 88 520 390 • Fax: +36 88 520 211

The Americas: Tel: +1-951 781-5500 • Fax: +1-951 781-5700

www.bourns.com



WARNING Cancer and Reproductive Harm - www.P65Warnings.ca.gov

* RoHS Directive 2002/95/EC Jan. 27, 2003 including annex and RoHS Recast 2011/65/EU June 8, 2011. Specifications are subject to change without notice. Users should verify actual device performance in their specific applications. The products described herein and this document are subject to specific legal disclaimers as set forth on the last page of this document, and at www.bourns.com/docs/legal/disclaimer.pdf

TBU-CA Series - TBU® High-Speed Protectors

BOURNS®

Electrical Characteristics (@ T_A = 25 °C Unless Otherwise Noted)

Symbol	Parameter	Part Number	Min.	Typ.	Max.	Unit	
I _{trigger}	Current required for the device to go from operating state to protected state	TBU-CAxxx-050-WH	50	75	100	mA	
		TBU-CAxxx-100-WH	100	150	200		
		TBU-CAxxx-200-WH	200	300	400		
		TBU-CAxxx-300-WH	300	450	600		
		TBU-CAxxx-500-WH	500	750	1000		
R _{device}	Series resistance of the TBU device	V _{imp} = 250 V I _{trigger} (min.) = 50 mA	TBU-CA025-050-WH		13.3	15.3	Ω
		V _{imp} = 250 V I _{trigger} (min.) = 100 mA	TBU-CA025-100-WH		7.1	8.2	
		V _{imp} = 250 V I _{trigger} (min.) = 200 mA	TBU-CA025-200-WH		4.2	4.8	
		V _{imp} = 250 V I _{trigger} (min.) = 300 mA	TBU-CA025-300-WH		3.2	3.8	
		V _{imp} = 250 V I _{trigger} (min.) = 500 mA	TBU-CA025-500-WH		2.6	3.0	
		V _{imp} = 400 V I _{trigger} (min.) = 50 mA	TBU-CA040-050-WH		14.3	16.5	
		V _{imp} = 400 V I _{trigger} (min.) = 100 mA	TBU-CA040-100-WH		8.1	9.4	
		V _{imp} = 400 V I _{trigger} (min.) = 200 mA	TBU-CA040-200-WH		5.2	6.0	
		V _{imp} = 400 V I _{trigger} (min.) = 300 mA	TBU-CA040-300-WH		4.3	5.0	
		V _{imp} = 400 V I _{trigger} (min.) = 500 mA	TBU-CA040-500-WH		3.6	4.2	
		V _{imp} = 500 V I _{trigger} (min.) = 50 mA	TBU-CA050-050-WH		15.7	18.0	
		V _{imp} = 500 V I _{trigger} (min.) = 100 mA	TBU-CA050-100-WH		9.5	10.9	
		V _{imp} = 500 V I _{trigger} (min.) = 200 mA	TBU-CA050-200-WH		6.6	7.5	
		V _{imp} = 500 V I _{trigger} (min.) = 300 mA	TBU-CA050-300-WH		5.6	6.5	
		V _{imp} = 500 V I _{trigger} (min.) = 500 mA	TBU-CA050-500-WH		5.0	5.7	
		V _{imp} = 650 V I _{trigger} (min.) = 50 mA	TBU-CA065-050-WH		17.7	20.3	
		V _{imp} = 650 V I _{trigger} (min.) = 100 mA	TBU-CA065-100-WH		11.5	13.2	
		V _{imp} = 650 V I _{trigger} (min.) = 200 mA	TBU-CA065-200-WH		8.6	9.8	
		V _{imp} = 650 V I _{trigger} (min.) = 300 mA	TBU-CA065-300-WH		7.6	8.8	
		V _{imp} = 650 V I _{trigger} (min.) = 500 mA	TBU-CA065-500-WH		7.0	8.0	
		V _{imp} = 850 V I _{trigger} (min.) = 50 mA	TBU-CA085-050-WH		21.4	24.5	
		V _{imp} = 850 V I _{trigger} (min.) = 100 mA	TBU-CA085-100-WH		15.2	17.4	
		V _{imp} = 850 V I _{trigger} (min.) = 200 mA	TBU-CA085-200-WH		12.3	14.0	
		V _{imp} = 850 V I _{trigger} (min.) = 300 mA	TBU-CA085-300-WH		11.3	13.0	
V _{imp} = 850 V I _{trigger} (min.) = 500 mA	TBU-CA085-500-WH		10.7	12.2			
t _{block}	Time for the device to go from normal operating state to protected state				1	μs	
I _Q	Current through the triggered TBU® device with 50 Vdc circuit voltage		0.25	0.50	1.00	mA	
V _{reset}	Voltage below which the triggered TBU® device will transition to normal operating state		12	16	20	V	
R _{th(j-l)}	Junction to package pads - FR4 using recommended pad layout			98		°C/W	
R _{th(j-l)}	Junction to package pads - FR4 using heat sink on board (6 cm ²) (1 in ²)			40		°C/W	

Environmental Characteristics

Parameter	Value
Moisture Sensitivity Level	1
ESD Classification (HBM)	1B

Specifications are subject to change without notice.

Users should verify actual device performance in their specific applications.

The products described herein and this document are subject to specific disclaimers as set forth on the last page of this document, and at www.bourns.com/legal/disclaimer.pdf.

TBU-CA Series - TBU® High-Speed Protectors

BOURNS®

Reference Application

The TBU® devices are general use protectors used in a wide variety of applications. The maximum voltage rating of the TBU® device should never be exceeded. Where necessary, an OVP should be employed to limit the maximum voltage. A cost-effective protection solution combines Bourns® TBU® protection devices with a pair of Bourns® MOVs. For bandwidth sensitive applications, a Bourns® GDT may be substituted for the MOV.

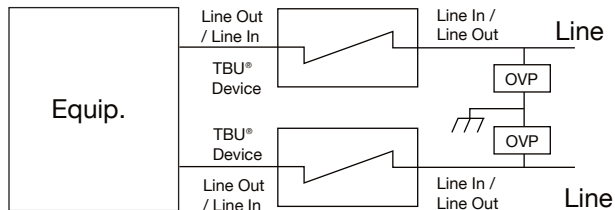

Basic TBU Operation

The TBU® device, constructed using MOSFET semiconductor technology, placed in the system circuit will monitor the current with the MOSFET detection circuit triggering to provide an effective barrier behind which sensitive electronics are not exposed to large voltages or currents during surge events. The TBU® device operates in approximately 1 μ s - once line current exceeds the TBU® device's trigger current $I_{trigger}$. When operated, the TBU® device will limit the current to less than the $I_{trigger}$ value within the t_{block} duration. If voltage above V_{reset} is continuously sustained, the TBU® device will subsequently reduce the current to a quiescent current level within a period of time that is dependent upon the applied voltage.

After the surge, the TBU® device resets when the voltage across the TBU® device falls to the V_{reset} level. The TBU® device will automatically reset on lines which have no DC bias or have DC bias below V_{reset} (such as unpowered signal lines).

If the line has a normal DC bias above V_{reset} , the voltage across the TBU® device may not fall below V_{reset} after the surge. In such cases, special care needs to be taken to ensure that the TBU® device will reset, with software monitoring as one method used to accomplish this. Bourns application engineers can provide further assistance.

Performance Graphs

Typical V-I Characteristics (TBU-CA050-300-WH)

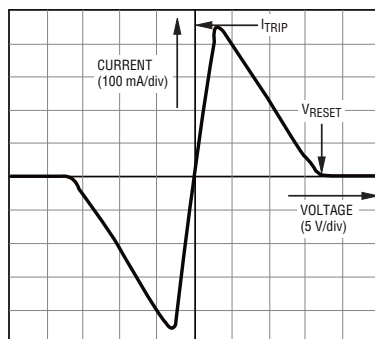

Typical Trigger Current vs. Temperature

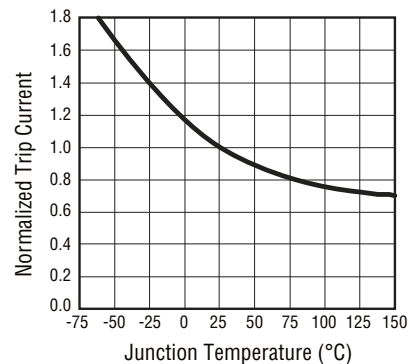

Power Derating Curve

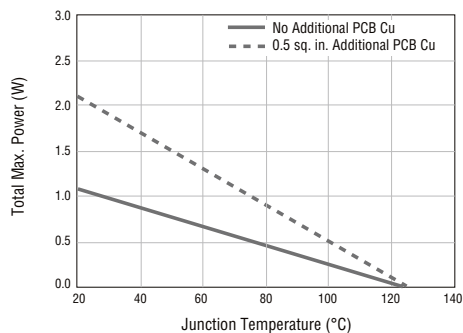

Typical Resistance vs. Temperature

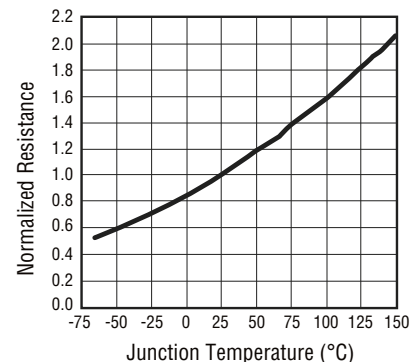

Specifications are subject to change without notice.

Users should verify actual device performance in their specific applications.

The products described herein and this document are subject to specific disclaimers as set forth on the last page of this document, and at www.bourns.com/legal/disclaimer.pdf.

Product Dimensions

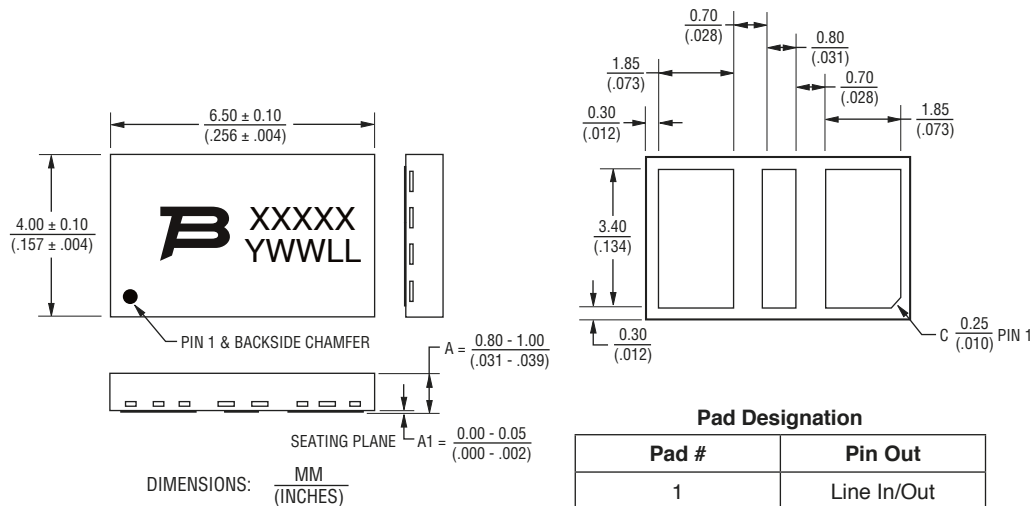

Pad Designation

Pad #	Pin Out
1	Line In/Out
2	NU
3	Line Out/In

Recommended Pad Layout

TBU® High-Speed Protectors have a 100 % matte-tin termination finish. For improved thermal dissipation, the recommended layout uses PCB copper areas which extend beyond the exposed solder pad. The exposed solder pads should be defined by a solder mask which matches the pad layout of the TBU® device in size and spacing. It is recommended that they should be the same dimension as the TBU® pads but if smaller solder pads are used, they should be centered on the TBU® package terminal pads and not more than 0.10-0.12 mm (0.004-0.005 in.) smaller in overall width or length. Solder pad areas should not be larger than the TBU® pad sizes to ensure adequate clearance is maintained. The recommended stencil thickness is 0.10-0.12 mm (0.004-0.005 in.) with a stencil opening size 0.025 mm (0.0010 in.) less than the solder pad size. Extended copper areas beyond the solder pad significantly improve the junction to ambient thermal resistance, resulting in operation at lower junction temperatures with a corresponding benefit of reliability. All pads should be soldered to the PCB, including pads marked as NC or NU but no electrical connection should be made to these pads. For minimum parasitic capacitance, it is recommended that signal, ground or power signals are not routed beneath any pad.

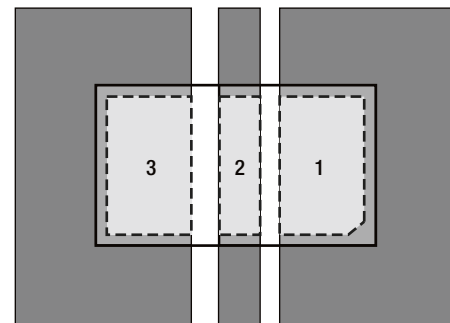

Dark grey areas show added PCB copper area for better thermal resistance.

Specifications are subject to change without notice.

Users should verify actual device performance in their specific applications.

The products described herein and this document are subject to specific disclaimers as set forth on the last page of this document, and at www.bourns.com/legal/disclaimer.pdf.

TBU-CA Series - TBU® High-Speed Protectors

BOURNS®

Reflow Profile

Profile Feature	Pb-Free Assembly
Average Ramp-Up Rate (T _{smax} to T _p)	3 °C/sec. max.
Preheat	
- Temperature Min. (T _{smin})	150 °C
- Temperature Max. (T _{smax})	200 °C
- Time (t _{smin} to t _{smax})	60-180 sec.
Time maintained above:	
- Temperature (T _L)	217 °C
- Time (t _L)	60-150 sec.
Peak/Classification Temperature (T _p)	260 °C
Time within 5 °C of Actual Peak Temp. (t _p)	20-40 sec.
Ramp-Down Rate	6 °C/sec. max.
Time 25 °C to Peak Temperature	8 min. max.

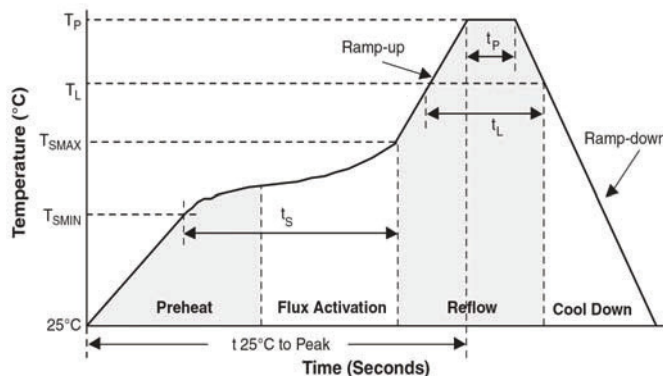

How to Order

TBU - CA 085 - 500 - WH

TBU® Product	_____	_____	_____	_____
Series	_____	_____	_____	_____
CA = Bi-Series				
Impulse Voltage Rating	_____	_____	_____	_____
025 = 250 V				
040 = 400 V				
050 = 500 V				
065 = 650 V				
085 = 850 V				
Trigger Current	_____	_____	_____	_____
050 = 50 mA				
100 = 100 mA				
200 = 200 mA				
300 = 300 mA				
500 = 500 mA				
Hold to Trip Ratio Suffix	_____	_____	_____	_____
W = Hold to Trip Ratio				
Package Suffix	_____	_____	_____	_____
H = DFN Package				

Typical Part Marking

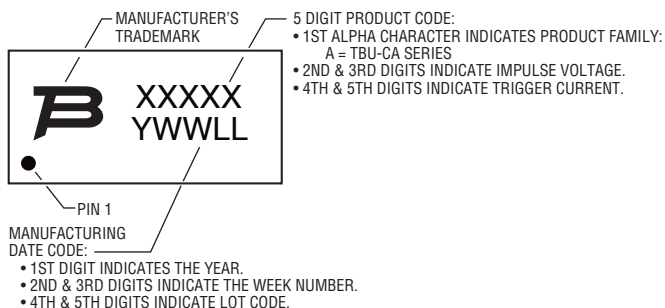

Thermal Resistance vs Additional PCB Cu Area

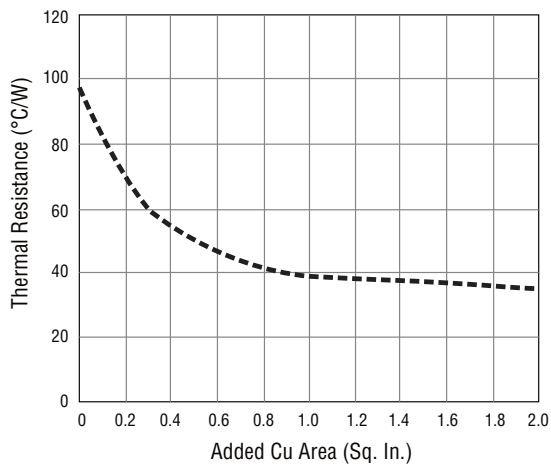

Specifications are subject to change without notice.

Users should verify actual device performance in their specific applications.

The products described herein and this document are subject to specific disclaimers as set forth on the last page of this document, and at www.bourns.com/legal/disclaimer.pdf.

TBU-CA Series - TBU® High-Speed Protectors

BOURNS®

Packaging Specifications

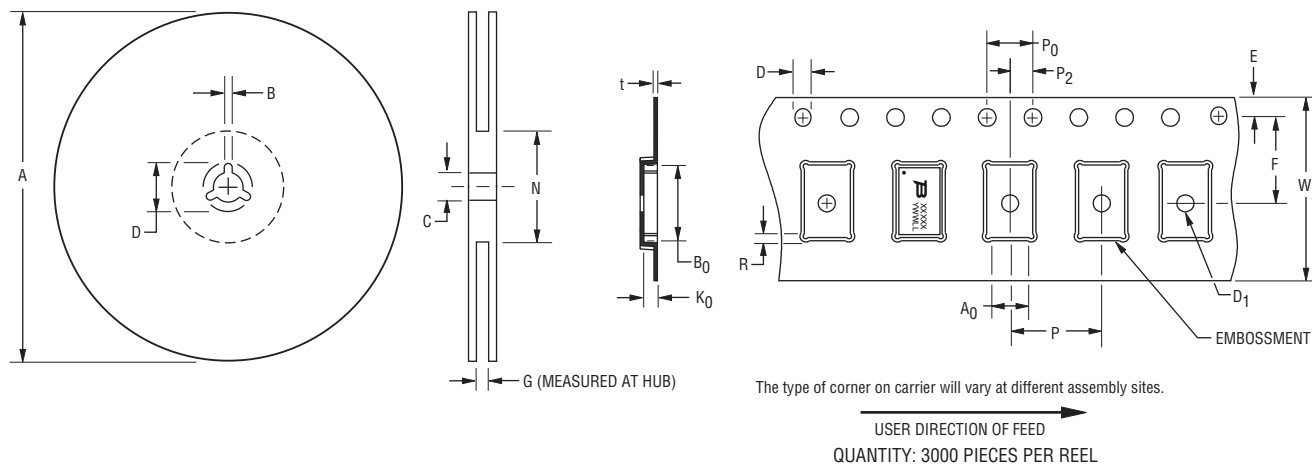

A		B		C		D		G	N
Min.	Max.	Min.	Max.	Min.	Max.	Min.	Max.	Ref.	Ref.
$\frac{326}{(.12.835)}$	$\frac{330}{(.13.002)}$	$\frac{1.5}{(.059)}$	$\frac{2.5}{(.098)}$	$\frac{12.8}{(.504)}$	$\frac{13.5}{(.531)}$	$\frac{20.2}{(.795)}$	-	$\frac{16.5}{(.650)}$	$\frac{102}{(4.016)}$

A ₀		B ₀		D		D ₁		E		F	
Min.	Max.	Min.	Max.	Min.	Max.	Min.	Max.	Min.	Max.	Min.	max.
$\frac{4.3}{(.169)}$	$\frac{4.5}{(.177)}$	$\frac{6.7}{(.264)}$	$\frac{6.9}{(.272)}$	$\frac{1.5}{(.059)}$	$\frac{1.6}{(.063)}$	$\frac{1.5}{(.059)}$	-	$\frac{1.65}{(.065)}$	$\frac{1.85}{(.073)}$	$\frac{7.4}{(.291)}$	$\frac{7.6}{(.299)}$

K ₀		P		P ₀		P ₂		R		t	
Min.	Max.	Min.	Max.	Min.	Max.	Min.	Max.	Min.	Max.	Min.	Max.
$\frac{1.0}{(.039)}$	$\frac{1.2}{(.047)}$	$\frac{7.9}{(.311)}$	$\frac{8.1}{(.319)}$	$\frac{3.9}{(.159)}$	$\frac{4.1}{(.161)}$	$\frac{1.9}{(.075)}$	$\frac{2.1}{(.083)}$	$\frac{0}{(0)}$	$\frac{0.5}{(.020)}$	$\frac{0.25}{(.010)}$	$\frac{0.35}{(.014)}$

W	
Min.	Max.
$\frac{15.7}{(.618)}$	$\frac{16.3}{(.642)}$

DIMENSIONS: $\frac{\text{MM}}{\text{(INCHES)}}$

REV. 03/18

"TBU" is a registered trademark of Bourns, Inc. in the United States and other countries.

Specifications are subject to change without notice.

Users should verify actual device performance in their specific applications.

The products described herein and this document are subject to specific disclaimers as set forth on the last page of this document, and at www.bourns.com/legal/disclaimer.pdf.

This legal disclaimer applies to purchasers and users of Bourns® products manufactured by or on behalf of Bourns, Inc. and its affiliates (collectively, “Bourns”).

Unless otherwise expressly indicated in writing, Bourns® products and data sheets relating thereto are subject to change without notice. Users should check for and obtain the latest relevant information and verify that such information is current and complete before placing orders for Bourns® products.

The characteristics and parameters of a Bourns® product set forth in its data sheet are based on laboratory conditions, and statements regarding the suitability of products for certain types of applications are based on Bourns’ knowledge of typical requirements in generic applications. The characteristics and parameters of a Bourns® product in a user application may vary from the data sheet characteristics and parameters due to (i) the combination of the Bourns® product with other components in the user’s application, or (ii) the environment of the user application itself. The characteristics and parameters of a Bourns® product also can and do vary in different applications and actual performance may vary over time. Users should always verify the actual performance of the Bourns® product in their specific devices and applications, and make their own independent judgments regarding the amount of additional test margin to design into their device or application to compensate for differences between laboratory and real world conditions.

Unless Bourns has explicitly designated an individual Bourns® product as meeting the requirements of a particular industry standard (e.g., ISO/TS 16949) or a particular qualification (e.g., UL listed or recognized), Bourns is not responsible for any failure of an individual Bourns® product to meet the requirements of such industry standard or particular qualification. Users of Bourns® products are responsible for ensuring compliance with safety-related requirements and standards applicable to their devices or applications.

Bourns® products are not recommended, authorized or intended for use in nuclear, lifesaving, life-critical or life-sustaining applications, nor in any other applications where failure or malfunction may result in personal injury, death, or severe property or environmental damage. Unless expressly and specifically approved in writing by two authorized Bourns representatives on a case-by-case basis, use of any Bourns® products in such unauthorized applications might not be safe and thus is at the user’s sole risk. Life-critical applications include devices identified by the U.S. Food and Drug Administration as Class III devices and generally equivalent classifications outside of the United States.

Bourns expressly identifies those Bourns® standard products that are suitable for use in automotive applications on such products’ data sheets in the section entitled “Applications.” Unless expressly and specifically approved in writing by two authorized Bourns representatives on a case-by-case basis, use of any other Bourns® standard products in an automotive application might not be safe and thus is not recommended, authorized or intended and is at the user’s sole risk. If Bourns expressly identifies a sub-category of automotive application in the data sheet for its standard products (such as infotainment or lighting), such identification means that Bourns has reviewed its standard product and has determined that if such Bourns® standard product is considered for potential use in automotive applications, it should only be used in such sub-category of automotive applications. Any reference to Bourns® standard product in the data sheet as compliant with the AEC-Q standard or “automotive grade” does not by itself mean that Bourns has approved such product for use in an automotive application.

Bourns® standard products are not tested to comply with United States Federal Aviation Administration standards generally or any other generally equivalent governmental organization standard applicable to products designed or manufactured for use in aircraft or space applications. Bourns expressly identifies Bourns® standard products that are suitable for use in aircraft or space applications on such products’ data sheets in the section entitled “Applications.” Unless expressly and specifically approved in writing by two authorized Bourns representatives on a case-by-case basis, use of any other Bourns® standard product in an aircraft or space application might not be safe and thus is not recommended, authorized or intended and is at the user’s sole risk.

The use and level of testing applicable to Bourns® custom products shall be negotiated on a case-by-case basis by Bourns and the user for which such Bourns® custom products are specially designed. Absent a written agreement between Bourns and the user regarding the use and level of such testing, the above provisions applicable to Bourns® standard products shall also apply to such Bourns® custom products.

Users shall not sell, transfer, export or re-export any Bourns® products or technology for use in activities which involve the design, development, production, use or stockpiling of nuclear, chemical or biological weapons or missiles, nor shall they use Bourns® products or technology in any facility which engages in activities relating to such devices. The foregoing restrictions apply to all uses and applications that violate national or international prohibitions, including embargos or international regulations. Further, Bourns® products and Bourns technology and technical data may not under any circumstance be exported or re-exported to countries subject to international sanctions or embargoes. Bourns® products may not, without prior authorization from Bourns and/or the U.S. Government, be resold, transferred, or re-exported to any party not eligible to receive U.S. commodities, software, and technical data.

To the maximum extent permitted by applicable law, Bourns disclaims (i) any and all liability for special, punitive, consequential, incidental or indirect damages or lost revenues or lost profits, and (ii) any and all implied warranties, including implied warranties of fitness for particular purpose, non-infringement and merchantability.

For your convenience, copies of this Legal Disclaimer Notice with German, Spanish, Japanese, Traditional Chinese and Simplified Chinese bilingual versions are available at:

Web Page: <http://www.bourns.com/legal/disclaimers-terms-and-policies>

PDF: <http://www.bourns.com/docs/Legal/disclaimer.pdf>