



CW48 Series

- Ratings from 10 A to 125 A @ 48-660 VAC
- SCR Output for heavy industrial loads
- LED Status Indicator
- UL/CSA/TUV Approved, CE Compliant to EN60950-1
- Improved SEMS screw and washer
- Redesigned housing with anti-rotation barriers
- AC or DC control and Universal AC/DC control
- EMC Compliant to Level 3
- Epoxy Free Design
- Removable IP20 touch-safe cover
- DBC substrate for superior thermal performance

For **Generation 3** datasheet [click here](#)

PRODUCT SELECTION

Control Voltage	10 A	25 A	50 A	90 A	125 A
4-32 VDC	CWD4810	CWD4825	CWD4850	CWD4890	CWD48125
90-280 VAC	CWA4810	CWA4825	CWA4850	CWA4890	CWA48125
18-36 VAC	CWA4810E	CWA4825E	CWA4850E	CWA4890E	CWA48125E
20-48 VDC/20-280 VAC	CWU4810	CWU4825	CWU4850	CWU4890	CWU48125

AVAILABLE OPTIONS

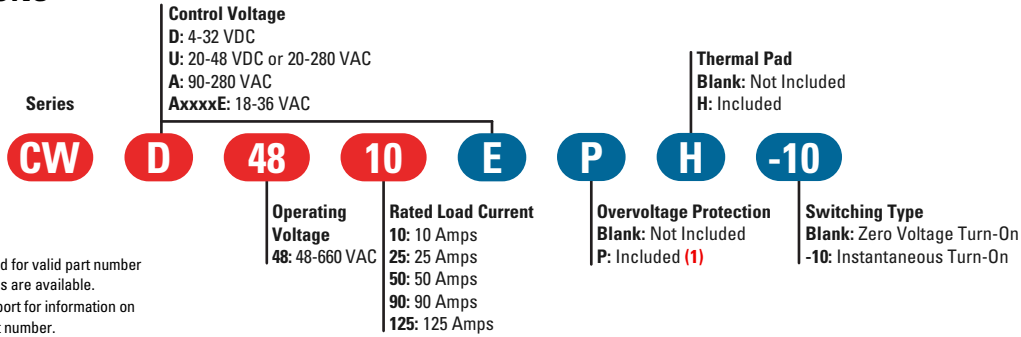

OUTPUT SPECIFICATIONS (2)

Description	10 A	25 A	50 A	90 A	125 A
Operating Voltage (47-440Hz) [Vrms]	48-660	48-660	48-660	48-660	48-660
Transient Overvoltage [Vpk] (1)	1200	1200	1200	1200	1200
Maximum Off-State Leakage Current @ Rated Voltage [mArms]	1	1	1	1	1
Minimum Off-State dv/dt @ Maximum Rated Voltage [V/μsec]	500	500	500	500	500
Maximum Load Current [Arms] (3)	10	25	50	90	125
Minimum Load Current [mArms]	150	150	150	250	250
Maximum 1 Cycle Surge Current (50/60Hz) [Apk]	380/400	570/600	810/850	1290/1350	1900/2000
Maximum On-State Voltage Drop @ Rated Current [Vpk]	1.3	1.3	1.3	1.3	1.25
Thermal Resistance Junction to Case [Rjc] [°C/W]	0.35	0.3	0.2	0.16	0.11
Maximum 1/2 Cycle I ² t for Fusing (50/60Hz) [A ² sec]	720/660	1620/1500	3280/3000	8320/7560	18000/16600
Minimum Power Factor (at Maximum load) (1)	0.5	0.5	0.5	0.5	0.5
HP Rating UL 508/IEC60947 [-10 Option][HP (KW)]: 120 VAC	0.5 (0.37)	1 (0.74)	2 (1.5)	3 (2.24)	5 (3.37)
HP Rating UL 508/IEC60947 [-10 Option][HP (KW)]: 240 VAC	1.5 (1.1)	3 (2.2)	5 (3.73)	7.5 (5.6)	10 (7.5)
HP Rating UL 508/IEC60947 [-10 Option][HP (KW)]: 480 VAC	3 (2.24)	5 (3.7)	7.5 (5.6)	10 (7.4)	15 (11.2)
HP Rating UL 508/IEC60947 [HP (KW)]: 120 VAC	0.5 (0.37)	0.75 (0.56)	1 (0.74)	2 (1.5)	3 (2.2)
HP Rating UL 508/IEC60947 [HP (KW)]: 240 VAC	1.5 (1.1)	2 (1.5)	3 (2.2)	5 (3.73)	7.5 (5.6)
HP Rating UL 508/IEC60947 [HP (KW)]: 480 VAC	3 (2.24)	5 (3.7)	7.5 (5.6)	10 (7.4)	15 (11.2)

INPUT SPECIFICATIONS (1)

Description	CWD	CWA	CWAxxxxE	CWU
Control Voltage Range	4-32 VDC	90-280 VAC (4)	18-36 VAC	20-48 VDC/20-280 VAC
Maximum Reverse Voltage	-32 VDC	-	-	-
Minimum Turn-On Voltage	4 VDC (5)	90 VAC	18 VAC	19 VDC/VAC
Minimum Turn-Off Voltage	1 VDC	10 VAC	4 VAC	5 VDC/VAC
Minimum Input Current (for on-state)	10 mA	6 mA	13 mA	7/13 mA
Maximum Input Current	15 mA	10 mA	15 mA	11/9 mA
Nominal Input Impedance	Current Regulated	Current Regulated	Current Regulated	Current Regulated
Maximum Turn-On Time [msec]	1/2 Cycle (6)	20	20	20
Maximum Turn-Off Time [msec]	1/2 Cycle	30	30	30

FDE-07-01 REV. A

GENERAL SPECIFICATIONS (1)

Description	Parameters
Dielectric Strength, Input/Output/Base (50/60Hz)	4000 Vrms
Minimum Insulation Resistance (@ 500 VDC)	10 ⁹ Ohms
Maximum Capacitance, Input/Output	8 pF
Ambient Operating Temperature Range (7)	-40 to 80 °C
Ambient Storage Temperature Range	-40 to 125 °C
Weight (typical)	2.88 oz (81.53 g)
Housing Material	UL94 V-0
Baseplate Material	Aluminum
Input Terminal Screw Torque Range (in-lbs/Nm)	13-15 / 1.5-1.7
Load Terminal Screw Torque Range (in-lbs/Nm)	18-20 / 2-2.2
SSR Mounting Screw Torque Range (in-lbs/Nm)	18-20 / 2-2.2
Input/Output Terminal Screw Thread Size	#6-32 UNC / #8-32 UNC
Humidity per IEC60068-2-78	93% non-condensing
LED Input Status Indicator	Green
MTBF (Mean Time Between Failures) at 40°C ambient temperature (8)	11,641,553 hours (1,328 years)
MTBF (Mean Time Between Failures) at 60°C ambient temperature (8)	7,210,376 hours (823 years)

WIRING DIAGRAM

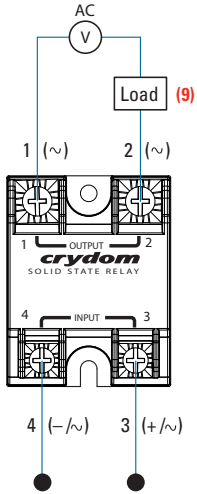

Recommended Wire Sizes		
Terminals	Wire Size (Solid / Stranded)	Wire Pull-Out Strength (lbs)[N]
Input	24 AWG (0.2 mm ²) / 0.2 [minimum]	10 [44.5]
	2 x 12 AWG (3.3 mm ²) / 3.3 [maximum]	90 [400]
Output	20 AWG (0.5 mm ²) / 0.518 [minimum]	30 [133]
	2 x 10 AWG (5.3 mm ²) / 5.3 [maximum]	110 [490]
	2 x 8 AWG (8.4 mm ²) / 8.4 [maximum]	90 [400]

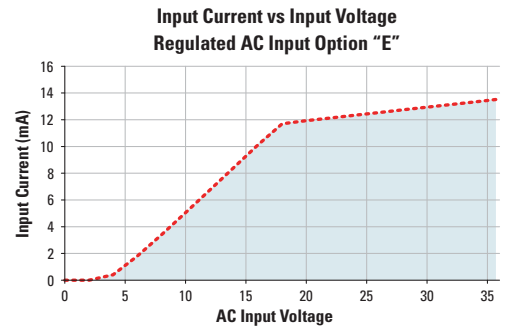
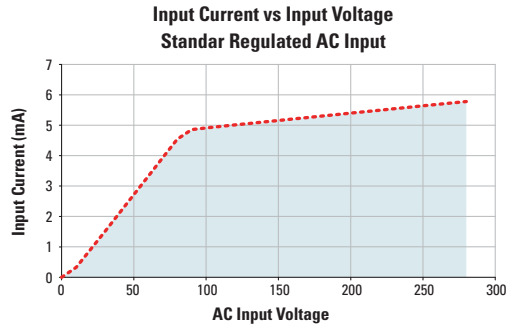
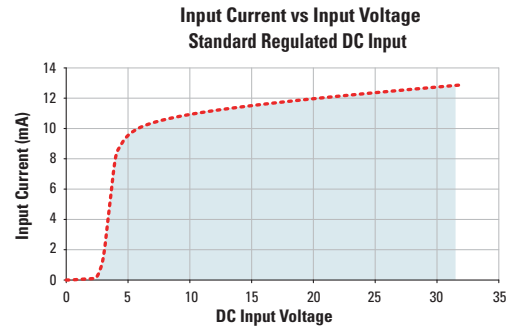

EQUIVALENT CIRCUIT BLOCK DIAGRAMS

CWD Series DC Control

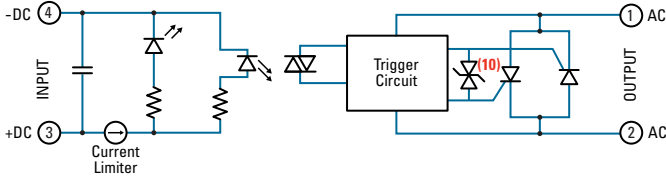

CWA/CWU Series AC Control

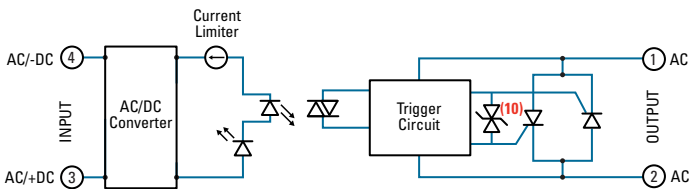

MECHANICAL SPECIFICATIONS ⁽¹⁾

Tolerances: ±0.02 in / 0.5 mm
 All dimensions are in: inches [millimeters]

Screw Termination

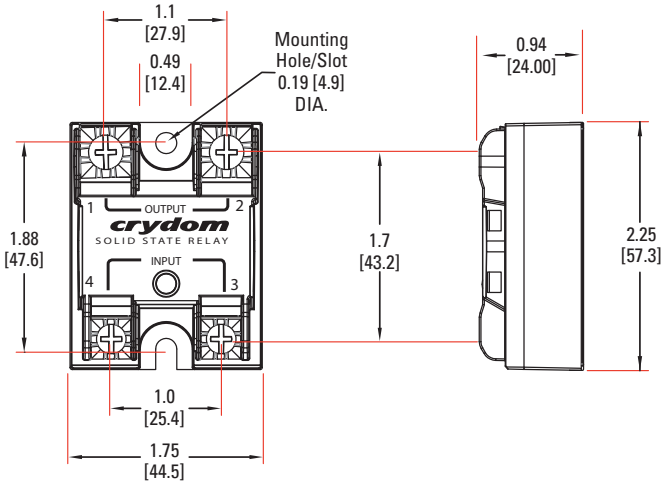

Screw Termination, IP20

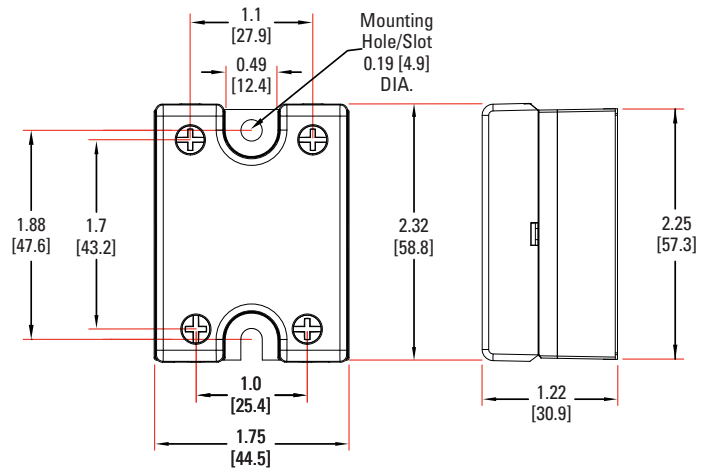

GENERAL NOTES

- (1) "P" option output will self trigger between 900-1200 Vpk. Power factor 0.7 or higher, not suitable for capacitive loads.
- (2) All parameters at 25°C unless otherwise specified.
- (3) Heat sinking required, see derating curves
- (4) For ambient temperature above 40°C the maximum control voltage must not exceed 250VAC.
- (5) Increase minimum voltage by 1V for operations from -20 to -40°C.
- (6) Turn-on time for Instantaneous turn-on versions is 0.1 msec and 7msec for CWU models.
- (7) AC input models operating range is -20 to 80 °C.
- (8) All parameters at 50% power rating and 100% duty cycle (contact Crydom tech support for detailed report).
- (9) Load can be wired to either SSR output terminal 1 or 2.
- (10) Select P option for overvoltage protection.
- (11) For single surge pulse Tc=25°C; Tj=125°C. For AC Output SSRs, AC Rms value of surge current equals the peak value divided by $\sqrt{2}$ (1.414).

For additional information or specific questions, contact Crydom Technical Support.

SURGE CURRENT INFORMATION --- Single Pulse (11)

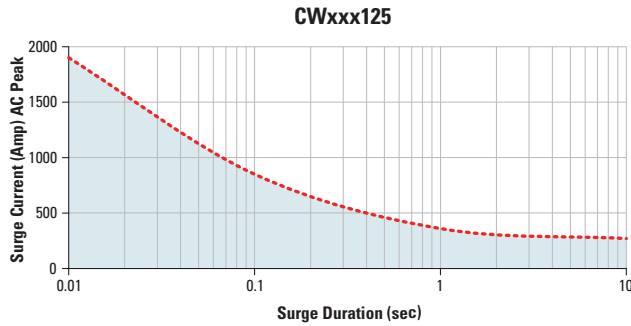
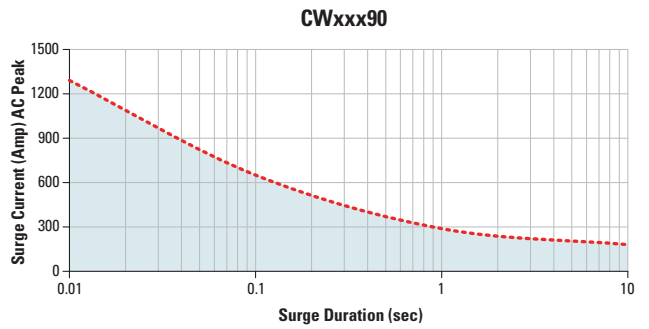
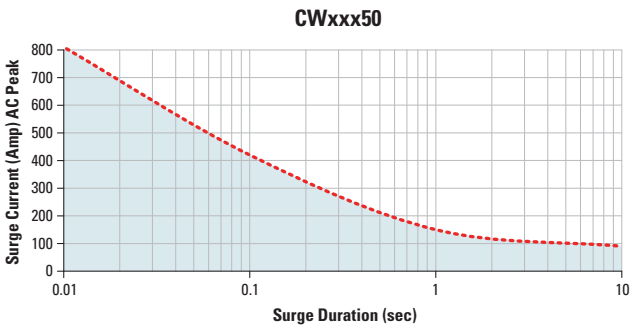
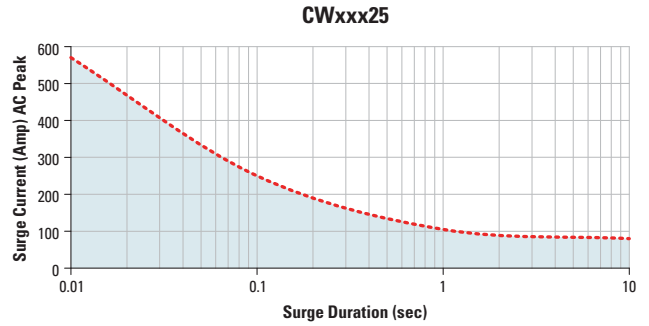
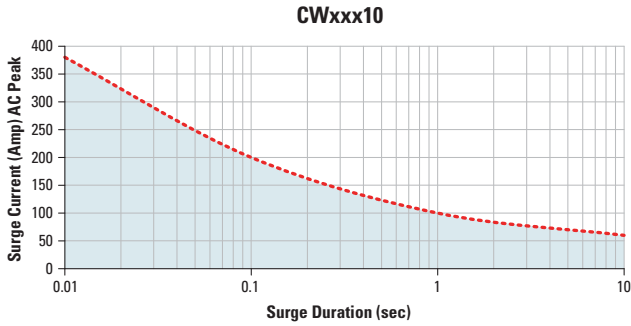

THERMAL DERATE INFORMATION

(i) SSR metal base plate acting as heat sink, it must be exposed to free ambient air.

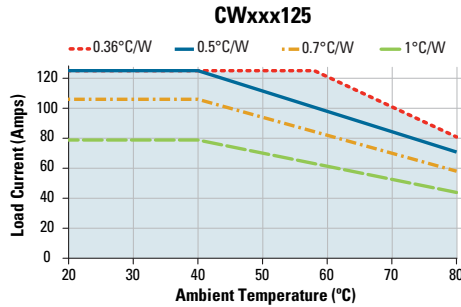
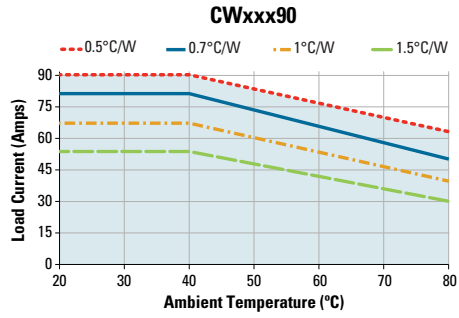
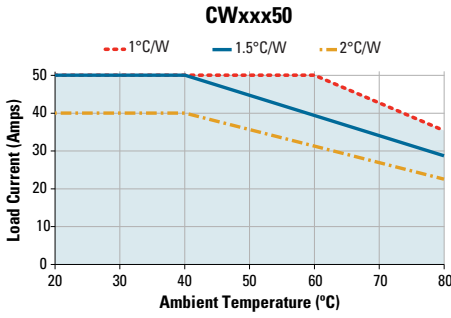
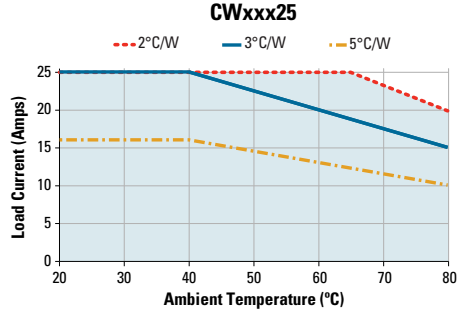
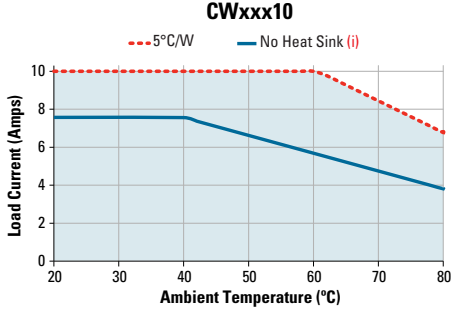

AGENCY APPROVALS

EN60950-1: Meets the requirements of sections 1.5: 1.7; 2.9: 2.10.5.3: 4.2: 4.5: 4.7:
 Certified according to EN 62314:2006
 IEC 61000-4-2 Electrostatic Discharge Level 3
 IEC 61000-4-4 Electrically Fast Transients Level 3
 IEC 61000-4-5 Electrical Surges Level 3



ACCESORIES





New Accessory!
Hardware Kits

Hardware Kit
 Part number: HK4



Bag with 2 square brass accessories and 2 screw 8-32 x 5/8 for output. Used to mount TMR1 lug terminals.

Recommended Accessories

 Cover	 Hardware Kit	 Heat Sink Part No.	Thermal Resistance [°C/W]	 Lug Terminal	 Thermal Pad
KS101	HK1	HS501DR	5.0	TRM1	HSP-1
	HK4	HS301 / HS301DR	3.0	TRM6	HSP-2
		HS251	2.5		
		HS201 / HS201DR	2.0		
		HS202 / HS202DR	2.0		
		HS172	1.7		
		HS151 / HS151DR	1.5		
		HS122 / HS122DR	1.2		
		HS103 / HS103DR	1.0		
		HS101	1.0		
		HS073	0.7		
		HS072	0.7		
		HS053	0.5		
		HS033	0.36		
HS023	0.25				

Rev. 092217
 ECN 20325

⚠ DANGER / PELIGRO / DANGER /GEFAHR / PERICOLO / 危險

<p>HAZARD OF ELECTRIC SHOCK, EXPLOSION, OR ARC FLASH.</p> <ul style="list-style-type: none"> • Disconnect all power before installing or working with this equipment. • Verify all connections and replace all covers before turning on power. <p>Failure to follow these instructions will result in death or serious injury.</p>	<p>RIESGO DE DESCARGA ELECTRICA O EXPLOSION.</p> <ul style="list-style-type: none"> • Desconectar todos los suministros de energia a este equipo antes de trabajar con este equipo. • Verificar todas las conexiones y colocar todas las tapas antes de energizar el equipo. <p>El incumplimiento de estas instrucciones puede provocar la muerte o lesiones serias.</p>	<p>RISQUE DE DESCARGE ELECTRIQUE OU EXPLOSION</p> <ul style="list-style-type: none"> • Eteindre toutes les sources d'énergie de cet appareil avant de travailler dessus de cet appareil • Vérifier tous connections, et remettre tous couverts en olace avant de mettre sous <p>De non-suivi de ces instructions provoquera la mort ou des lésions sérieuses.</p>	<p>GEFAHR EINES ELEKTRISCHE N SCHLAGES ODER EINER EXPLOSION.</p> <ul style="list-style-type: none"> • Stellen Sie jeglichen Strom ab, der dieses Gerät versorgt, bevor Sie an dem Gerät Arbeiten durchführen • Vor dem Drehen auf Energie alle Anschlüsse überprüfen und alle Abdeckungen ersetzen. <p>Unterlassung dieser Anweisungen können zum Tode oder zu schweren Verletzungen führen.</p>	<p>RISCHIO DI SCOSSA ELETTRICA O DELL'ESPLOSIONE.</p> <ul style="list-style-type: none"> • Spenga tutta l'alimentazione che fornisce questa apparecchiatura prima di lavorare a questa apparecchiatura • Verificare tutti i collegamenti e sostituire tutte le coperture prima dell'accensione <p>L'omissione di queste istruzioni provocherà la morte o lesioni serie</p>	<p>存在电击、爆炸或电弧闪烁危险</p> <ul style="list-style-type: none"> • 在操作此设备之前请先关闭电源。 <p>若不遵守这些说明,可能会导致严重的人身伤害甚至死亡。</p>
--	--	---	--	--	---

⚠ WARNING / AVERTISSEMENT / WARNUNG /ADVERTENCIA / AVVERTENZA / 警告

<p>RISK OF MATERIAL DAMAGE AND HOT ENCLOSURE</p> <ul style="list-style-type: none"> • The product's side panels may be hot, allow the product to cool before touching. • Follow proper mounting instructions including torque values. • Do not allow liquids or foreign objects to enter this product. <p>Failure to follow these instructions can result in serious injury, or equipment damage.</p>	<p>RISQUE DE DOMMAGE MATERIEL ET DE SURCHAUFFE DU BOITIER</p> <ul style="list-style-type: none"> • Les panneaux latéraux du produit peuvent être chauds. Laisser le produit refroidir avant de le toucher. • Respecter les consignes de montage, et notamment les couples de serrage. • Ne pas laisser pénétrer de liquide ni de corps étrangers à l'intérieur du produit. <p>Le non-respect de cette directive peut entraîner, des lésions corporelles graves ou des dommages matériels.</p>	<p>GEFAHR VON MATERIALSCHÄDEN UND GEHÄUSEERHITZUNG</p> <ul style="list-style-type: none"> • Die Seitenwände können heiß sein. Lassen Sie das Produkt abkühlen, bevor Sie es berühren. • Beachten Sie die Montageanweisungen, • Führen Sie keine Flüssigkeiten oder Fremdkörper in das Produkt ein. <p>Die Nichtbeachtung dieser Anweisung kann Körperverletzung oder Materialschäden zur Folge haben.</p>
<p>RIESGO DE DAÑOS MATERIALES Y DE SOBRECALENTAMIENTO DE LA UNIDAD</p> <ul style="list-style-type: none"> • Los paneles laterales del producto pueden estar calientes. Esperar que el producto se enfríe antes de tocarlo. • Respetar las instrucciones de montaje, y en particular los pares de apretado. • No dejar que penetren líquidos o cuerpos extraños en el producto. <p>Si no se respetan estas precauciones pueden producirse graves lesiones, daños materiales.</p>	<p>RISCHIO DI DANNI MATERIALI E D'INVOLUCRO CALDO</p> <ul style="list-style-type: none"> • I pannelli laterali dell'apparecchio possono scottare; lasciar quindi raffreddare il prodotto prima di toccarlo. • Seguire le istruzioni di montaggio corrette. • Non far entrare liquidi o oggetti estranei in questo apparecchio. <p>La mancata osservanza di questa precauzione può causare gravi rischi per l'incolumità personale o danni alle apparecchiature.</p>	<p>材料损坏和高温外壳的危险性</p> <ul style="list-style-type: none"> • 产品的一侧面板可能很热，在其冷却前请不要触碰。 • 遵照正确的安装说明，包括扭矩值。 • 请勿让液体及其他异物进入本产品。 <p>如不能正确执行这些操作说明,极有可能造成严重人体伤害或者设备的损坏。</p>

ANNEX - ENVIRONMENTAL INFORMATION

The environmental information disclosed in this annex including the EIP Pollution logo are in compliance with People’s Republic of China Electronic Industry Standard SJ/T11364 – 2006, Marking for Control of Pollution Caused by Electronic Information Products.

Part Name	Toxic or hazardous Substance and Elements					
	Lead (Pb)	Mercury (Hg)	Cadmium (Cd)	Hexavalent Chromium (Cr (VI))	Polybrominated biphenyls (PBB)	Polybrominated diphenyl ethers (PBDE)
Semiconductor die	X	O	O	O	O	O
Solder	X	O	O	O	O	O

附件 – 环保信息

此附件所标示的包括电子信息产品污染图标的环保信息符合中华人民共和国电子行业标准 SJ/T11364 - 2006, 电子信息产品污染控制标识要求。

部件名称	有毒有害物质或元素					
	铅 (Pb)	汞 (Hg)	镉 (Cd)	六价铬 (Cr (VI))	多溴联苯 (PBB)	多溴二苯醚 (PBDE)
半导体芯片	X	O	O	O	O	O
焊接点	X	O	O	O	O	O

