

MEGA® Fuse Rated 32V

RoHS



Specifications













Interrupting Rating:	2000A @ 32 VDC
Voltage Rating:	32 VDC
Operating Temperature Range:	40°C to + 125°C

The MEGA Fuse is designed for high current circuit protection up to 500A with "Diffusion Pill Technology." The MEGA Fuse also provides time delay characteristics. Designed and patented by Littelfuse, the MEGA Fuse is ideal for battery and alternator protection application and other heavy gauge cables requiring ultra-high current protection.

Die von Littelfuse entwickelte und patentierte MEGA-Sicherung in Diffusionspillen-Technologie mit träger Charakteristik ist für Überstrom-Schutzlösungen von bis zu 500A konzipiert. Sie eignet sich ideal für Batterie- und Generator-Schutzanwendungen oder andere Bereiche mit sehr großen Kabelquerschnitten, die extrem hohe Anforderungen an den Überstromschutz stellen.

Time-Current Characteristics / Schmelzeit-Grenzwerte

% of Rating % des Nennstromes	Opening Time Min / Max (s) Schmelzcharakteristik Min / Max (s)	
	40-250	300-500
75	- / -	4 hrs / -
100	4 hrs / -	- / -
135	120 s / 1800 s	- / 15 s
200	1 s / 15 s	1 s /
350	300 ms / 5 s	300 ms / 5 s
600	100 ms / 1 s	- / -

Part Number Artikel-Nr.	Current Rating Nennstrom	Color Kennfarbe	Typ. Voltage Drop Typ. Spannungsfall	Cold Resistance Kaltwiderstand	I ² t
0298040_	40 A	-	132 mV	2.510 mΩ	-
0298060_	60 A	-	119 mV	1.504 mΩ	-
0298080_	80 A		87 mV	0.720 mΩ	-
0298100_	100 A		87 mV	0.562 mΩ	31100 A ² s
0298125_	125 A		80 mV	0.423 mΩ	57800 A ² s
0298150_	150 A		92 mV	0.352 mΩ	100000 A ² s
0298175_	175 A		86 mV	0.294 mΩ	168000 A ² s
0298200_	200 A		83 mV	0.257 mΩ	204000 A ² s
0298225_	225 A		82 mV	0.222 mΩ	257000 A ² s
0298250_	250 A		82 mV	0.201 mΩ	389000 A ² s
0298300_*	300 A		74 mV**	0.167 mΩ	-
0298350_*	350 A		68 mV**	0.138 mΩ	-
0298400_*	400 A		64 mV**	0.126 mΩ	-
0298450_*	450 A		60 mV**	0.112 mΩ	-
0298500_*	500 A		58 mV**	0.092 mΩ	-

* Parts with asterik are short circuit protectors only. Corresponding holder see Section "Fuse Holders."

** Voltage Drop measurements for short circuit protectors are at 75% of rated current. Last figure of part number = packaging code, see Section "Packaging Index," pg. 157.

MEGA® Fuse Rated 32V

Dimensions in mm / Maße in mm

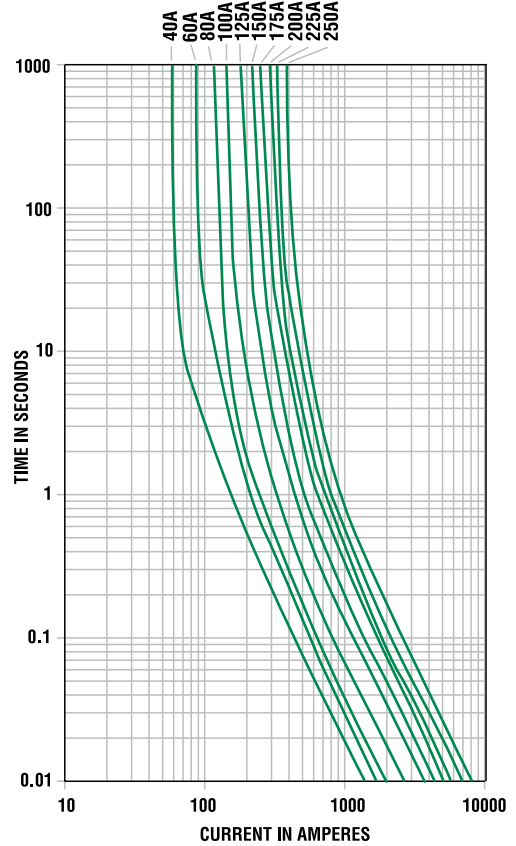
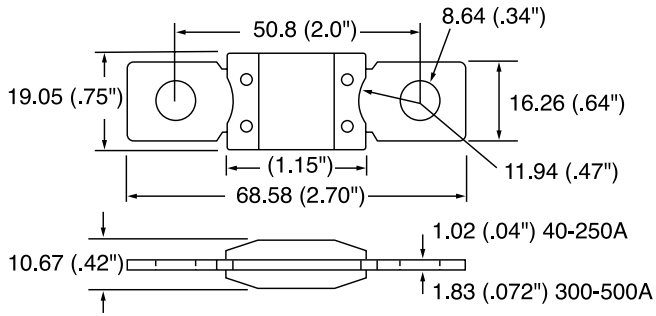

MEGA Fuse Series Temperature Rerating Curve

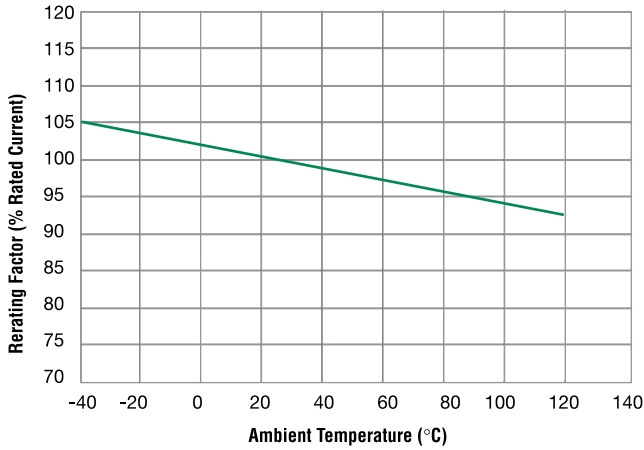

Bolt-down Fuses