STEVAL-MKI109V2: eMotion motherboard for MEMS adapter boards

Introduction

The STEVAL-MKI109V2 (eMotion) is a motherboard designed to provide the user with a complete ready-to-use platform for the demonstration of MEMS devices mounted on adapter boards.

The STEVAL-MKI109V2 uses an STM32F103RET6 microcontroller which functions as a bridge between the sensor on the adapter board and the PC on which it is possible to use the Unico graphical user interface (GUI) downloadable from the ST website or dedicated software routines for customized applications.

This user manual describes the hardware included with the demonstration kit and provides the information required to install the demonstration board and how to upgrade the firmware of the microcontroller.

For details regarding the features of each sensor, please refer to the datasheet available for each individual device.

1 Demonstration kit description

The eMotion is a complete demonstration kit that allows demonstration of both digital and analog MEMS sensors. Thanks to its DIL 24 connector, a wide range of MEMS adapter boards can be used.

The block diagram of the demonstration kit is shown in [Figure 1. Demonstration board block diagram](#).

Figure 1. Demonstration board block diagram

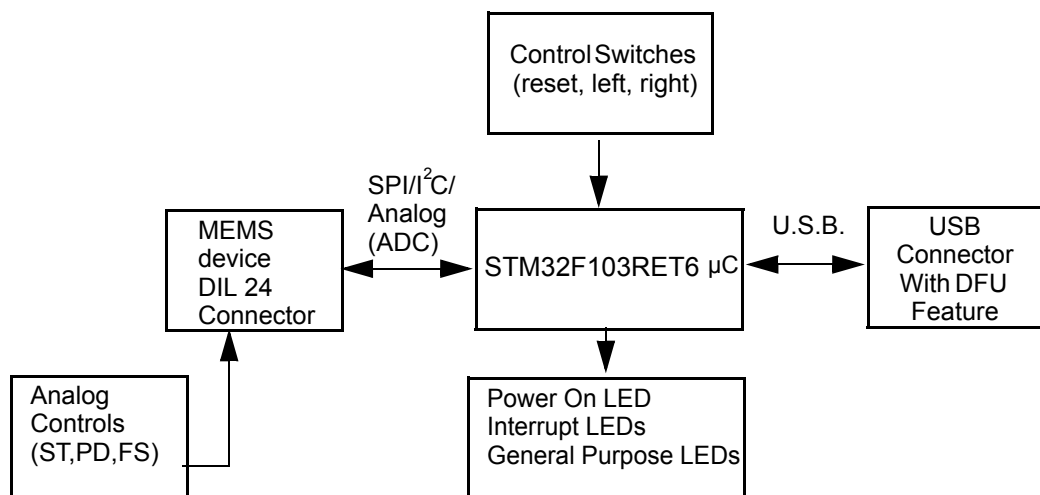

As shown in the [Figure 1. Demonstration board block diagram](#), the eMotion demonstration kit is based on the STM32F103RET6 microcontroller and can be connected to the PC through the USB bus. Data coming from the MEMS sensor connected to the board can be read through the PC GUI provided with the kit.

The eMotion also implements the DFU (device firmware upgrade) feature, therefore, in the case of a new firmware release, it can be reprogrammed without the need to use a programmer. See www.st.com/mems for new firmware releases.

The eMotion also integrates three general-purpose LEDs, two LEDs connected directly to the interrupt pins of digital adapters and the power/USB LED. Moreover, the eMotion integrates three buttons: two are available to the user on a dedicated GPIO of the microcontroller, while the other is used as reset for the microcontroller.

All the MEMS adapter pins are available on two connectors placed on the board ([Figure 2. Top silkscreen of the eMotion kit JP2 and JP3](#)).

The top silkscreen view and image of the full board are shown in [Figure 2. Top silkscreen of the eMotion kit](#) and [Figure 3. Board top view](#) respectively.

Figure 2. Top silkscreen of the eMotion kit

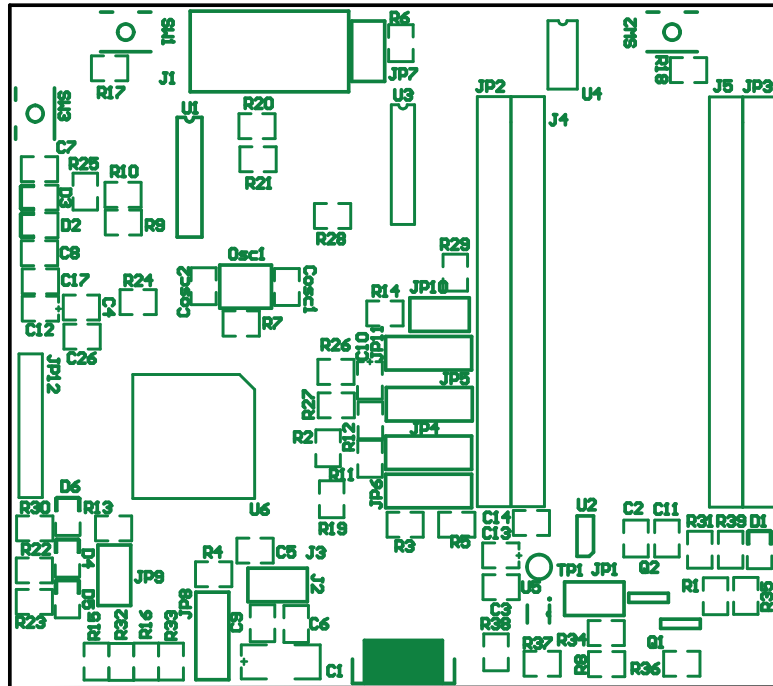
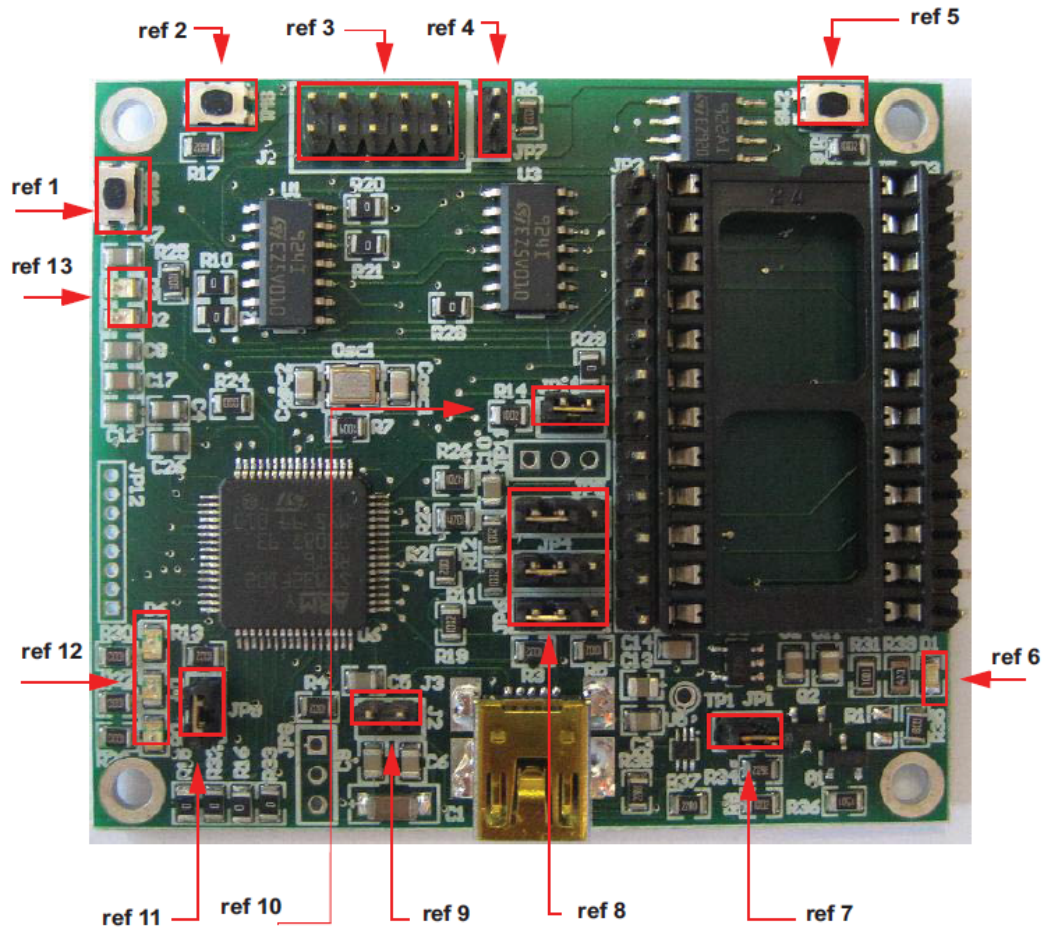

Figure 3. Board top view

In order to use the eMotion demonstration kit, installation of a dedicated driver is required, which is included in the installation pack, together with a GUI interface which allows simple interaction with the sensor. The steps required for driver and software installation are described in the following sections.

In [Figure 3. Board top view](#) some main components placed on the top layer of the eMotion kit are highlighted.

- Jumpers JP9 and JP10 ([Figure 3. Board top view](#), ref 10, ref 11) are used to select the STM32 boot mode. When the eMotion is used together with MEMS adapters, JP9 and JP10 must be fitted (see STM32 datasheet for more information).
- Jumper J2 ([Figure 3. Board top view](#), ref 7) can be used to directly supply the board (from 3.5 V to 6 V) instead of using the USB connector.
- Jumper JP1 allows the user to measure the sensor current consumption by connecting a multimeter in series with its terminals ([Figure 3. Board top view](#), ref 9).
- Jumpers JP4, JP5, and JP6 ([Figure 3. Board top view](#), ref 8) are used to manually set some features which are available for just some of the analog MEMS adapters (see [Table 1. Jumper configuration for power-down \(PD\), self test \(ST\), and high-pass filter reset \(HP\)](#) for more details). JP4 is used to set the self-test feature, JP5 to handle the power-down pin, and JP6 to reset the MEMS high-pass filter. When they are fitted on pins 2-3, these functions are handled by the firmware itself.

Table 1. Jumper configuration for power-down (PD), self test (ST), and high-pass filter reset (HP)

	Jumper on 1-2 position	Jumper on 2-3 position	Jumper unfitted
JP4 ST	logic level 1: self-test ON	Self-test is handled by the firmware	logic level 0: self-test OFF, default
JP5 PD	logic level 1: power-down mode	Power-down is handled by the firmware	logic level 0: normal mode, default
JP6 HP	logic level 1: external high-pass filter reset	High-pass filter reset is handled by the firmware	logic level 0: normal mode, default

- J1 connector ([Figure 3. Board top view](#), ref 3) can be used to both reprogram the STM32 and to debug the code through the JTAG or SWD protocols.
- Jumper JP7 ([Figure 3. Board top view](#), ref 4) is used to select either JTAG (JP7 unfitted) or SWD (JP7 fitted) mode.
- eMotion also integrates six LEDs and three buttons:
 - LED D1 ([Figure 3. Board top view](#), ref 6) is switched on when the board is power supplied.
 - LEDs D2 and D3 ([Figure 3. Board top view](#), ref 13) are directly connected to the interrupt pins of the MEMS digital adapters (if available on the sensor mounted on the adapter board).
 - LEDs D4, D5, and D6 ([Figure 3. Board top view](#), ref 12) are general-purpose LEDs and are used to indicate firmware states. For example, LED D6 is switched on when a specific firmware is selected from those available. LED D5 on indicates that the microcontroller is well configured for communication with the sensor. Finally the LED D4 blinks according to the sensor data rate selected.
 - Button SW3 ([Figure 3. Board top view](#), ref 1) is used to reset the STM32.
 - Button SW1 and SW2 ([Figure 3. Board top view](#), ref 2 and ref 5) are connected to STM32 GPIOs and are available to the user.

[Figure 4. How to connect the DIL24 adapter board to the STEVAL-MKI109V2](#) shows how to properly mount the DIL24 adapter board on the STEVAL-MKI109V2 board.

Figure 4. How to connect the DIL24 adapter board to the STEVAL-MKI109V2

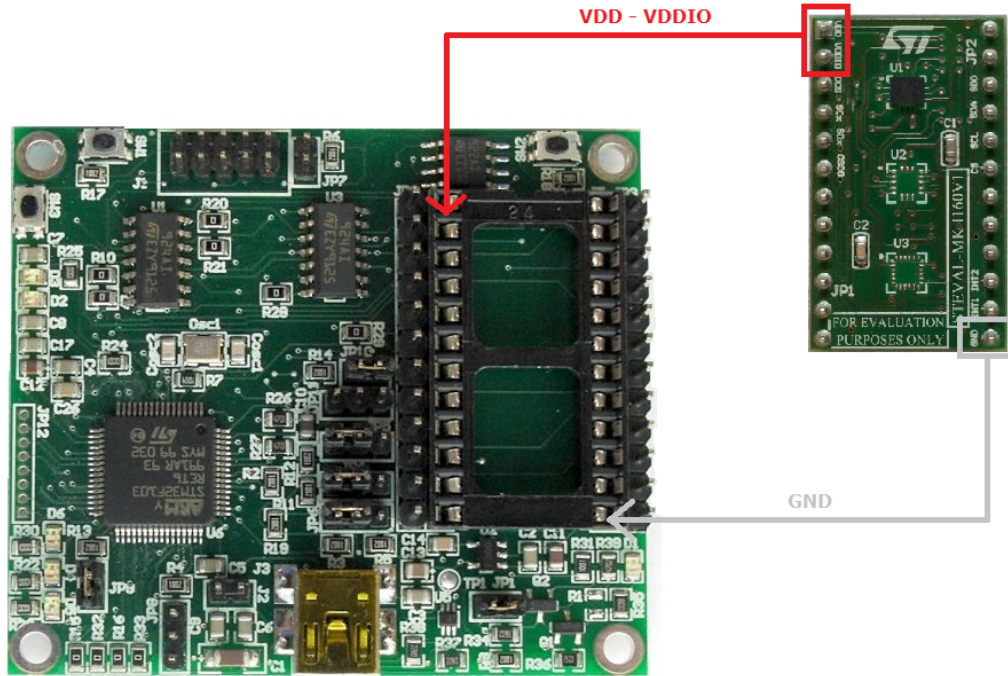

2 eMotion board installation

The software package can be downloaded from the st.com website and includes the following directory structure:

- DRIVER: it contains the installation package for the USB drivers needed to connect the eMotion board to the PC. No driver is needed on Linux and Mac OS platforms, so this directory is included in the Windows installation package only.
- DFU: it contains the .dfu files and the installation package for the software needed to upgrade the firmware of the eMotion board.
- FIRMWARE: it contains the source code of the firmware of the eMotion board together with the corresponding binary file that can be flashed to the board using the DFU software.

The section below describes the procedure to install the driver for the eMotion board (needed on Windows platforms only) and the DFU software.

2.1 Hardware installation (Windows platforms)

No driver installation is needed on Linux and Mac OS platforms.

To install the STM32 virtual COM port driver on Windows platforms, launch the “VCPDriver_V1.4.0_Setup.exe” included in the Windows installation package under the “DRIVER” folder and follow the instructions on the screen. Once the driver is installed, insert the demonstration kit board into a free USB port. A notification message should appear, as in [Figure 5. Notification message](#).

Figure 5. Notification message

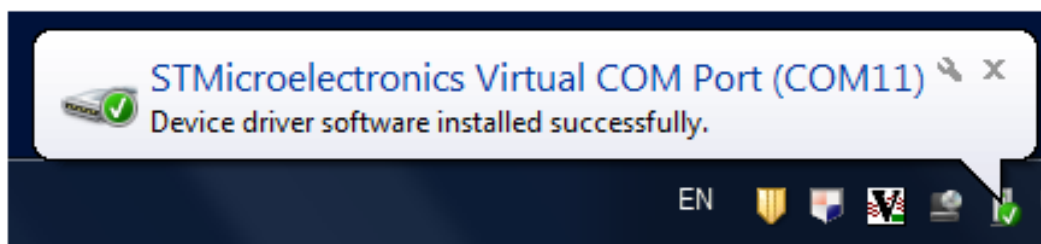

Now the eMotion should be recognized by the PC as a virtual COM. In order to confirm which COM port has been assigned to the board, right click on “My Computer” and select “Manage”, select “Device Manager” and scroll through the list until “Ports (COM & LPT)”. In the following example ([Figure 6. Virtual COM port assignment](#)) the COM11 has been assigned to the board.

Figure 6. Virtual COM port assignment

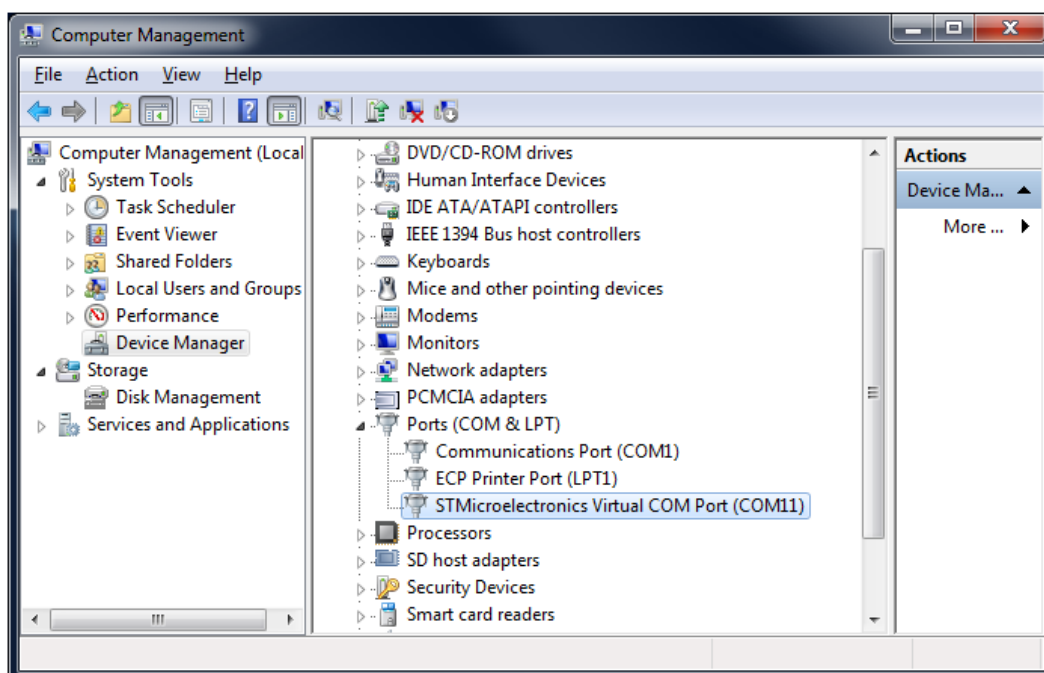

2.2 DFU

The MEMS STEVAL-MKI109V2 demonstration board is capable of reprogramming an application through the USB, in accordance with the DFU class specification defined by the USB Implementers Forum. This capability is useful because it allows reprogramming the microcontroller directly in the field and is particularly well-suited to USB applications where the same USB connector can be used both for the standard operating mode and for the reprogramming process.

In order to configure the eMotion board in DFU mode button SW2 must be pressed before supplying the board and released when the LEDs D1, D4, D5, and D6 light up.

If the firmware version in use is lower than V3.0.0, it's mandatory to patch the DFU feature using the "DFU_Patcher_V1.0.2.dfu" file available under the "DFU" folder before proceeding with the upgrade of the firmware with a version equal to or higher than V3.0.0. The procedure to patch the DFU feature corresponds to the one used during a standard firmware upgrade with the DFU tool. At the end of this procedure, if the green LED D4 is on, it indicates that the procedure is successfully completed; if the red LED D5 is on, the procedure failed and has to be repeated. Before proceeding with the new firmware upgrade the board must be reset using the SW3 button.

2.2.1 DFU on Windows

To install the DFU software, launch the "DfuSe_Demo_V3.0.5_Setup.exe" included in the software package under the "DFU" folder and follow the instructions on the screen. To launch the software, select "Start > STMicroelectronics > DfuSe > DfuSe Demonstration".

In the 'Upgrade or Verify Action' section of the Dfuse Demo tool click on the 'Choose...' button and select the target .dfu file; then click the 'Upgrade' button to start the firmware upgrade.

For more details regarding DFU and the microcontroller ST GUI, see the related user manual located under "Start > STMicroelectronics > DfuSe > Docs > DfuSe Getting Started".

2.2.2 DFU on Linux

The DFU program used for Linux operating systems is 'dfu-util'.

The procedure for Ubuntu Linux operating systems is described below.

To install this program, open a terminal and write the following command (with sudo to ensure having the correct permissions):

```
sudo apt-get install dfu-util
```

Create a udev rules file:

```
sudo gedit /etc/udev/49-emotion.rules
```

and fill it with the following content:

```
# 0483:5740 - STM32F4 in USB Serial Mode (CN5) ATTRS{idVendor}=="0483", ATTRS{idProduct}=="5740",  
ENV{ID_MM_DEVICE_IGNORE}="1"  
ATTRS{idVendor}=="0483", ATTRS{idProduct}=="5740", ENV{MTP_NO_PROBE}="1"  
SUBSYSTEMS=="usb", ATTRS{idVendor}=="0483", ATTRS{idProduct}=="5740", MODE:="0666"  
KERNEL=="ttyACM*", ATTRS{idVendor}=="0483", ATTRS{idProduct}=="5740", MODE:="0666"  
# 0483:df11 - STM32F4 in DFU mode (CN5) SUBSYSTEMS=="usb", ATTRS{idVendor}=="0483",  
ATTRS{idProduct}=="df11", MODE:="0666"
```

Tell udev to reload its rules:

```
sudo udevadm control --reload-rules
```

You should now be able to program the board. So, connect the eMotion board in DFU mode, and run the following command:

```
sudo dfu-util -a 0 -D dfu_path/file.dfu -d 0483:df11
```

where *dfu_path* and *file.dfu* are the path to the dfu file and the dfu file name respectively

(example: `sudo dfu-util -a 0 -D Desktop/eMotionV2_REL_4_0.dfu -d 0483:df11`).

To use the board with the upgraded firmware you need to disconnect and reconnect it, in order to exit DFU mode.

2.2.3 DFU on Mac OS

The DFU program used for Mac operating systems is 'dfu-util'. Before installing it, you need to install Homebrew.

To do that, you need to open a terminal and run the following command:

```
ruby -e "$(curl -fsSL https://raw.githubusercontent.com/Homebrew/homebrew/go/install)"
```

Once Homebrew is installed on your Mac, you can install dfu-utils with the following command:

```
brew install dfu-util
```

You should now be able to program the board. So, connect the eMotion board in DFU mode, and run the following command:

```
dfu-util -a 0 -D dfu_path/file.dfu -d 0483:df11
```

where *dfu_path* and *file.dfu* are the path to the dfu file and the dfu file name respectively

(example: `dfu-util -a 0 -D Desktop/eMotionV2_REL_4_0.dfu -d 0483:df11`).

To use the board with the upgraded firmware you need to disconnect and reconnect it, in order to exit DFU mode.

3 Supported MEMS adapter boards

Table 2. List of supported MEMS adapter boards below provides the complete list of supported adapter boards.

Table 2. List of supported MEMS adapter boards

Adapter board	Device
STEVAL-MKI009V1	LIS3LV02DL
STEVAL-MKI013V1	LIS302DL
STEVAL-MKI015V1	LIS344ALH
STEVAL-MKI075V1	LY3100ALH
STEVAL-MKI084V1	LPY430AL
STEVAL-MKI087V1	LIS331DL
STEVAL-MKI089V1	LIS331DLH
STEVAL-MKI092V1	LIS331HH
STEVAL-MKI097V1	LPR430AL
STEVAL-MKI098V1	LPR410AL
STEVAL-MKI105V1	LIS3DH
STEVAL-MKI106V1	LSM303DLHC
STEVAL-MKI107V2	L3GD20
STEVAL-MKI108V2	9AXISMODULE v2 [LSM303DLHC + L3GD20]
STEVAL-MKI110V1	AIS328DQ
STEVAL-MKI113V1	LSM303DLM
STEVAL-MKI114V1	MAG PROBE (based on LSM303DLHC)
STEVAL-MKI120V1	LPS331AP
STEVAL-MKI122V1	LSM330DLC
STEVAL-MKI123V1	LSM330D
STEVAL-MKI124V1	10AXISMODULE [LSM303DLHC + L3GD20+ LPS331AP]
STEVAL-MKI125V1	A3G4250D
STEVAL-MKI133V1	LSM303D
STEVAL-MKI134V1	LIS3DSH
STEVAL-MKI135V1	LIS2DH
STEVAL-MKI136V1	L3GD20H
STEVAL-MKI137V1	LIS3MDL
STEVAL-MKI141V2	HTS221
STEVAL-MKI142V1	LPS25H
STEVAL-MKI151V1	LIS2DH12
STEVAL-MKI152V1	LIS2DM
STEVAL-MKI153V1	H3LIS331DL
STEVAL-MKI154V1	LSM9DS0
STEVAL-MKI158V1	AIS3624DQ
STEVAL-MKI159V1	LSM9DS1

Adapter board	Device
STEVAL-MKI160V1	LSM6DS3
STEVAL-MKI161V1	LSM6DS0
STEVAL-MKI163V1	LSM303C
STEVAL-MKI164V1	LIS2HH12
STEVAL-MKI165V1	LPS25HB
STEVAL-MKI166V1	H3LIS100DL
STEVAL-MKI167V1	H3LIS200DL
STEVAL-MKI168V1	IIS2DH
STEVAL-MKI169V1	I3G4250D
STEVAL-MKI170V1	IIS328DQ
STEVAL-MKI172V1	LSM303AGR
STEVAL-MKI175V1	LIS2DE12
STEVAL-MKI176V1	LSM6DS3H
STEVAL-MKI177V1	LPS35HW
STEVAL-MKI178V1	LSM6DSL
STEVAL-MKI179V1	LIS2DW12
STEVAL-MKI180V1	LIS3DHH
STEVAL-MKI181V1	LIS2MDL
STEVAL-MKI182V1	ISM330DLC
STEVAL-MKI183V1	LPS33HW
STEVAL-MKI185V1	IIS2MDC
STEVAL-MKI186V1	IIS3DHHC
STEVAL-MET001V1	LPS22HB

4 Supported commands

The microcontroller mounted on the eMotion board is equipped with dedicated firmware that supports a set of commands which allow to control either the digital or the analog output MEMS sensor and permits the acquisition of the measured data. The firmware also handles the communication between the board and the PC through the USB bus. These features allow the user to easily write their own applications to exploit the capabilities of the sensor chosen.

This section describes the commands that are supported by the firmware for the microcontroller of the eMotion demonstration kit.

4.1 Getting started

Before using the commands supported by the firmware, the following procedure must be performed:

1. Connect the eMotion to the USB port
2. Launch an application which allows to send commands through the virtual serial port. The remainder of this document assumes the use of "Microsoft[®] HyperTerminal" program available with the Windows XP operating system
3. Create a new connection, enter a name (e.g. "STEVAL-MKI109V2"), and click "OK"
4. In the "Connect Using" field, select the virtual COM port to which the USB port has been mapped, and click "OK"
5. In port settings, set bits per second to 115200, data bits to 8, parity to none, stop bits to 1, and flow control to none. Click "OK"
6. In the "HyperTerminal" application window choose "files" > "properties" > "settings", then click on the "ASCII Setup" button
7. Select "Send line ends with line feeds" and "Echo typed characters locally"
8. Click the "OK" button to close the "ASCII Setup" window
9. Click the "OK" button to close the "Properties" window.

Once this procedure has been completed, the user can utilize the commands described in the following sections by typing them in the "HyperTerminal" window.

4.2 Supported commands

The firmware supports a wide range of MEMS adapters; the next section provides the complete list of supported commands (see [Table 3. Supported commands list](#)) and their description.

Then, split into sections, the list of commands available for each sensor supported by the eMotion firmware is provided.

4.2.1 Commands list and description

Table 3. Supported commands list

Command	Description	Returned value
*setdbXXXVY	Selects firmware according to the adapter connected	
*start	Starts continuous data acquisition	(see Table 4. Returned values for *start command)
*debug	Returns the output data in readable text format	(see Table 5. Returned values for *debug command)
*stop	Stops data acquisition	
*Zon	Forces 3-state	
*Zoff	Exits from 3-state	
*dev	Device name	e.g.: LIS3DH
*ver	Firmware version	e.g.: V1.0
*rAA	Accelerometer register read	e.g.: RAAhDDh
*wAADD	Accelerometer register write	
*grAA	Gyroscope register read	e.g.: GRAAhDDh
*gwAADD	Gyroscope register write	
*mrAA	Magnetometer register read	e.g.: MRAAhDDh
*mwAADD	Magnetometer register write	
*prAA	Pressure sensor register read	e.g.: PRAAhDDh
*pwAADD	Pressure sensor register write	
*hrAA	Humidity sensor register read	e.g.: HRAAhDDh
*hwaADD	Humidity sensor register write	
*single	It gets a single X, Y, and Z data acquisition	(see Table 5. Returned values for *debug command)
*list	Prints the list of MKIs supported	e.g.: MKI105V1
*listdev	Prints the list of devices supported	e.g.: LIS3DH
*echoon	Activates the write verbose mode	e.g.: RAAhDDh
*echooff	Deactivates the write verbose mode	
*fiforst	Accelerometer "Reset mode" enable	st 0 0 0 0 0 0 IR FC FS
*fifomde	Accelerometer "FIFO mode" enable	st 0 0 0 0 0 0 IR FC FS
*fifostr	Accelerometer "FIFO Stream" enable	st 0 0 0 0 0 0 IR FC FS
*fifostf	Accelerometer "Stream-to-FIFO" enable	st 0 0 0 0 0 0 IR FC FS
*fifobtf	Accelerometer "Bypass-to-FIFO" enable	st 0 0 0 0 0 0 IR FC FS
*fifobts	Accelerometer "Bypass-to-Stream" enable	st 0 0 0 0 0 0 IR FC FS
*fifodstr	Accelerometer "Dynamic Stream" enable	st 0 0 0 0 0 0 IR FC FS
*gfforst	Gyroscope "Reset mode" enable	st 0 0 0 0 0 0 IR FC FS
*gffomde	Gyroscope "FIFO mode" enable	st 0 0 0 0 0 0 IR FC FS

Command	Description	Returned value
*gfifostr	Gyroscope "FIFO Stream" enable	st 0 0 0 0 0 0 IR FC FS
*gfifostf	Gyroscope "Stream-to-FIFO" enable	st 0 0 0 0 0 0 IR FC FS
*gfifobtf	Gyroscope "Bypass-to-FIFO" enable	st 0 0 0 0 0 0 IR FC FS
*gfifobts	Gyroscope "Bypass-to-Stream" enable	st 0 0 0 0 0 0 IR FC FS
*gfifodstr	Gyroscope "Dynamic Stream" enable	st 0 0 0 0 0 0 IR FC FS
*mfiforst	Magnetometer "Reset mode" enable	st 0 0 0 0 0 0 IR FC FS
*mfifomde	Magnetometer "FIFO mode" enable	st 0 0 0 0 0 0 IR FC FS
*mfifostr	Magnetometer "FIFO Stream" enable	st 0 0 0 0 0 0 IR FC FS
*mfifostf	Magnetometer "Stream-to-FIFO" enable	st 0 0 0 0 0 0 IR FC FS
*mfifobtf	Magnetometer "Bypass-to-FIFO" enable	st 0 0 0 0 0 0 IR FC FS
*mfifobts	Magnetometer "Bypass-to-Stream" enable	st 0 0 0 0 0 0 IR FC FS
*mfifodstr	Magnetometer "Dynamic Stream" enable	st 0 0 0 0 0 0 IR FC FS
*pfiforst	Pressure sensor "Reset mode" enable	st 0 0 0 0 0 0 IR FC FS
*pfifomde	Pressure sensor "FIFO mode" enable	st 0 0 0 0 0 0 IR FC FS
*pfifostr	Pressure sensor "FIFO Stream" enable	st 0 0 0 0 0 0 IR FC FS
*pfifostf	Pressure sensor "Stream-to-FIFO" enable	st 0 0 0 0 0 0 IR FC FS
*pfifobtf	Pressure sensor "Bypass-to-FIFO" enable	st 0 0 0 0 0 0 IR FC FS
*pfifobts	Pressure sensor "Bypass-to-Stream" enable	st 0 0 0 0 0 0 IR FC FS
*pfifodstr	Pressure sensor "Dynamic Stream" enable	st 0 0 0 0 0 0 IR FC FS
*PDON	Sets power-down pin	
*PDOFF	Clears power-down pin	
*STON	Sets self-test pin	
*STOFF	Clears self-test pin	
*HPON	Sets high-pass filter pin	
*HPOFF	Clears high-pass filter pin	
*FSON	Sets full-scale pin	
*FSOFF	Clears full-scale pin	

Note: IR: interrupt byte; FC: FIFO control register; FS: FIFO source register.

Set demonstration board

The command *setdbxxxvy selects the part of the firmware able to handle the adapter board sensor connected to the board. e.g., in order to select the firmware for the LIS3DH the command must be: *setdb105V1. The D6 LED (green) is automatically switched on.

Start command

The *start command initiates the continuous data acquisition. When this command is sent to the device, it returns a string of bytes (plus carriage return and line feed) similar to "st OUT1 OUT2 OUT3 IR BT".

The first two bytes are always the ASCII char "s" and "t" which correspond to the hexadecimal values {73h 74h}. OUT1, OUT2, and OUT3 are the bytes that contain the values measured at device outputs; if the output data is represented on more than 8 bits, OUT1, OUT2, and OUT3 are split into two bytes: high byte (e.g.: "XH") and low byte (e.g.: "XL").

IR contains the interrupt bytes and BT contains the bytes that describe the state of the buttons integrated on the board.

Specifically, bit#0 of the “BT” data corresponds to the status of the SW1 button on the demonstration kit board: it is set to 1 when the SW1 is pressed (otherwise 0). Bit#1 has the same behavior but is dedicated to the SW2.

Before sending the *start command, the device must be out from 3-state and some registers must be configured according to user needs, therefore, *start must be preceded by a *zoff and some “Register Write” commands.

Table 4. Returned values for *start command shows the format of the string returned for each device when a *start command is sent.

Table 4. Returned values for *start command

STEVAL # (Device)	Returned value
STEVAL-MKI009V1 (LIS3LV02DL) STEVAL-MKI089V1 (LIS331DLH) STEVAL-MKI092V1 (LIS331HH) STEVAL-MKI105V1 (LIS3DH) STEVAL-MKI107V2 (L3GD20) STEVAL-MKI110V1 (AIS328DQ) STEVAL-MKI125V1 (A3G4250D) STEVAL-MKI134V1 (LIS3DSH) STEVAL-MKI135V1 (LIS2DH) STEVAL-MKI136V1 (L3GD20H) STEVAL-MKI151V1 (LIS2DH12) STEVAL-MKI153V1 (H3LIS331DL) STEVAL-MKI158V1 (AIS3624DQ) STEVAL-MKI164V1 (LIS2HH12) STEVAL-MKI166V1 (H3LIS100DL) STEVAL-MKI167V1 (H3LIS200DL) STEVAL-MKI168V1 (IIS2DH) STEVAL-MKI169V1 (I3G4250D) STEVAL-MKI170V1 (IIS328DQ) STEVAL-MKI179V1 (LIS2DW12) STEVAL-MKI180V1 (LIS3DHH) STEVAL-MKI186V1 (IIS3DHHC)	s t XH XL YH YL ZH ZL int1 int2 sw1 sw2 \lr \ln
STEVAL-MKI013V1 (LIS302DL) STEVAL-MKI087V1 (LIS331DL) STEVAL-MKI152V1 (LIS2DM) STEVAL-MKI175V1 (LIS2DE12)	s t X Y Z int1 int2 sw1 sw2 \lr \ln
STEVAL-MKI176V1 (LSM6DS3H) STEVAL-MKI178V1 (LSM6DSL) STEVAL-MKI182V1 (ISM330DLC)	s t A_XH A_XL A_YH A_YL A_ZH A_ZL G_XH G_XL G_YH G_YL G_ZH G_ZL STEP_L STEP_H int1_int2 sw1 sw2 \lr \ln
STEVAL-MKI015V1 (LIS344ALH) STEVAL-MKI114V1 (MAG PROBE)	s t XH XL YH YL ZH ZL sw1 sw2 \lr \ln
STEVAL-MKI137V1 (LIS3MDL) STEVAL-MKI181V1 (LIS2MDL) STEVAL-MKI185V1 (IIS2MDC)	s t XH XL YH YL ZH ZL int1 sw1 sw2 \lr \ln

STEVAL # (Device)	Returned value
STEVAL-MKI075V1 (LY3100ALH) STEVAL-MKI084V1 (LPY430AL) STEVAL-MKI097V1 (LPR430AL) STEVAL-MKI098V1 (LPR410AL)	s t vrefH vrefL o1H o1L out1H out1L out4H out4L o2H o2L out2H out2L out5H out5L o3H o3L out3H out3L out6H out6L sw1 sw2 \r \n
STEVAL-MKI106V1 (LSM303DLHC) STEVAL-MKI113V1 (LSM303DLM) STEVAL-MKI133V1 (LMS303D)	s t A_XH A_XL A_YH A_YL A_ZH A_ZL M_XH M_XL M_YH M_YL M_ZH M_ZL A_int1 A_int2 sw1 sw2 \r \n
STEVAL-MKI108V2 (9AXISMODULEv2) STEVAL-MKI154V1 (LSM9DS0)	s t A_XH A_XL A_YH A_YL A_ZH A_ZL G_XH G_XL G_YH G_YL G_ZH G_ZL M_XH M_XL M_YH M_YL M_ZH M_ZL A_int1 A_int2 sw1 sw2 \r \n
STEVAL-MKI159V1 (LSM9DS1)	s t A_XH A_XL A_YH A_YL A_ZH A_ZL G_XH G_XL G_YH G_YL G_ZH G_ZL M_XH M_XL M_YH M_YL M_ZH M_ZL A_int1 A_int2 M_int3 sw1 sw2 \r \n
STEVAL-MKI120V1 (LPS331AP)	s t PXL PL PH TL TH REF_PXL REF_PL REF_PH REF_TL REF_TH int1 int 2 sw1 sw2 \r \n
STEVAL-MKI122V1 (LSM330DLC) STEVAL-MKI123V1 (LSM330D)	s t A_XH A_XL A_YH A_YL A_ZH A_ZL G_XH G_XL G_YH G_YL G_ZH G_ZL A_int1 A_int2 G_int1 G_int2 sw1 sw2 \r \n
STEVAL-MKI124V1 (10AXISMODULE)	s t A_XH A_XL A_YH A_YL A_ZH A_ZL G_XH G_XL G_YH G_YL G_ZH G_ZL M_XH M_XL M_YH M_YL M_ZH M_ZL PXL PL PH TL TH REF_PXL REF_PL REF_PH REF_TL REF_TH A_int1 A_int2 sw1 sw2 \r \n
STEVAL-MKI141V2 (HTS221)	s t HL HH TL TH int1 sw1 sw2 \r \n
STEVAL-MKI142V1 (LPS25H) STEVAL-MKI165V1 (LPS25HB) STEVAL-MKI177V1 (LPS35HW) STEVAL-MKI183V1 (LPS33HW) STEVAL-MET001V1 (LPS22HB)	s t PXL PL PH TL TH REF_PXL REF_PL REF_PH int1 sw1 sw2 \r \n
STEVAL-MKI160V1 (LSM6DS3)	s t A_XH A_XL A_YH A_YL A_ZH A_ZL G_XH G_XL G_YH G_YL G_ZH G_ZL STEP_L STEP_H TEMP_L TEMP_H int1_int2_sw1 sw2 \r \n
STEVAL-MKI161V1 (LSM6DS0)	s t A_XH A_XL A_YH A_YL A_ZH A_ZL G_XH G_XL G_YH G_YL G_ZH G_ZL int1_int2_sw1 sw2 \r \n
STEVAL-MKI172V1 (LSM303AGR)	s t A_XH A_XL A_YH A_YL A_ZH A_ZL M_XH M_XL M_YH M_YL M_ZH M_ZL A_int1 A_int2 M_int3 sw1 sw2 \r \n

Note: XH: X-axis output high byte (same for Y-axis, Z-axis, P pressure, H humidity, and TEMP temperature)

XL: X-axis output low byte (same for Y-axis, Z-axis, P pressure, H humidity, and TEMP temperature)

Debug command

The *debug command starts the continuous data acquisition in debug mode. When this command is sent to the board, it returns the output values measured by the device formatted in a readable text format. The values shown on the screen correspond to the LSB data shown as a decimal number.

Table 5. Returned values for *debug command shows the format of the string returned for each device when a *debug command is sent.

Table 5. Returned values for *debug command

STEVAL # (Device)	Returned value
STEVAL-MKI009V1 (LIS3LV02DL) STEVAL-MKI013V1 (LIS302DL) STEVAL-MKI015V1 (LIS344ALH) STEVAL-MKI087V1 (LIS331DL) STEVAL-MKI089V1 (LIS331DLH) STEVAL-MKI092V1 (LIS331HH) STEVAL-MKI105V1 (LIS3DH) STEVAL-MKI110V1 (AIS328DQ) STEVAL-MKI134V1 (LIS3DSH) STEVAL-MKI135V1 (LIS2DH) STEVAL-MKI151V1 (LIS2DH12) STEVAL-MKI152V1 (LIS2DM) STEVAL-MKI153V1 (H3LIS331DL) STEVAL-MKI158V1 (AIS3624DQ) STEVAL-MKI164V1 (LIS2HH12) STEVAL-MKI166V1 (H3LIS100DL) STEVAL-MKI167V1 (H3LIS200DL) STEVAL-MKI168V1 (IIS2DH) STEVAL-MKI170V1 (IIS328DQ) STEVAL-MKI175V1 (LIS2DE12)	X=XXXXX Y=YYYYY Z=ZZZZZ
STEVAL-MKI084V1 (LPY430AL) STEVAL-MKI097V1 (LPR430AL) STEVAL-MKI098V1 (LPR410AL)	VREF=VVVVV OUT1=XXXXX 4OUT1=XXXXX OUT3=YYYYY OUT6=YYYYY
STEVAL-MKI075V1 (LY3100ALH)	VREF=VVVVV OUT1=XXXXX 4OUT1=XXXXX
STEVAL-MKI106V1 (LSM303DLHC) STEVAL-MKI113V1 (LSM303DLM) STEVAL-MKI133V1 (LSM303D) STEVAL-MKI163V1 (LSM303C) STEVAL-MKI172V1 (LSM303AGR)	AX=XXXXX AY=YYYYY AZ=ZZZZZ MX=XXXXX MY=YYYYY MZ=ZZZZZ
STEVAL-MKI114V1 (MAG PROBE) STEVAL-MKI137V1 (LIS3MDL)	MX=XXXXX MY=YYYYY MZ=ZZZZZ
STEVAL-MKI107V2 (L3GD20) STEVAL-MKI125V1 (A3G4250D) STEVAL-MKI136V1 (L3GD20H) STEVAL-MKI169V1 (I3G4250D)	P=PPPPP R=RRRRR Y=YYYYY
STEVAL-MKI108V2 (9AXISMODULEV2) STEVAL-MKI154V1 (LSM9DS0) STEVAL-MKI159V1 (LSM9DS1)	AX=XXXXX AY=YYYYY AZ=ZZZZZ MX=XXXXX MY=YYYYY MZ=ZZZZZ GX=XXXXX GY=YYYYY GZ=ZZZZZ

STEVAL # (Device)	Returned value
STEVAL-MKI120V1 (LPS331AP) STEVAL-MKI142V1 (LPS25H) STEVAL-MKI165V1 (LPS25HB) STEVAL-MKI177V1 (LPS35HW) STEVAL-MET001V1 (LPS22HB)	P=PPPPP T=TTTTT
STEVAL-MKI122V1 (LSM330DLC) STEVAL-MKI123V1 (LSM330D) STEVAL-MKI160V1 (LSM6DS3) STEVAL-MKI161V1 (LSM6DS0) STEVAL-MKI176V1 (LSM6DS3H) STEVAL-MKI178V1 (LSM6DSL)	AX=XXXXX AY=YYYYY AZ=ZZZZZ GX=XXXXX GY=YYYYY GZ=ZZZZZ
STEVAL-MKI124V1 (10AXISMODULE)	AX=XXXXX AY=YYYYY AZ=ZZZZZ MX=XXXXX MY=YYYYY MZ=ZZZZZ GX=XXXXX GY=YYYYY GZ=ZZZZZ P=PPPPP T=TTTTT
STEVAL-MKI141V2 (HTS221)	H=HHHHH T=TTTTT

Stop command

The *stop command interrupts any acquisition session that has been started with either the *start or *debug commands.

Zon and Zoff

The *Zon and *Zoff commands are employed, respectively, to put into 3-state the STM32F103RET6 microcontroller mounted on the demonstration kit. These commands allow the isolation of the sensor from the microprocessor and let the user interact with the sensor in a pure analog way.

By default, when the kit is first turned on, the lines are in 3-state mode and the user is required to send the *Zoff command to allow communication between the sensor and the microcontroller. If Zoff has not been launched, the firmware ignores any other command.

Device name

The *dev command retrieves the name of the adapter connected to the demonstration kit. The returned value is, for example, "LIS3DH".

Firmware version

The *ver command queries the demonstration kit and returns the version of the firmware loaded in the microprocessor, for example, "V1.0".

Accelerometer register read

The *rAA command allows the contents of the accelerometer registers in the demonstration kit board to be read. AA, expressed as a hexadecimal value and written in upper case, represents the address of the register to be read.

Once the read command is issued, the board returns RAAhDDh, where AA is the address sent by the user and DD is the data present in the register.

For example, to read the register at address 0x20, the user issues the command *r20, which returns, e.g., R20hC7h.

Accelerometer register write

The *wAADD command allows writing to the contents of the accelerometer registers in the demonstration kit board. AA and DD, expressed as hexadecimal values and written in upper case, represent, respectively, the

address of the register and the data to be written. For example, to write 0xC7 to the register at address 0x20, the user issues the command *w20C7.

Gyroscope register read

The *grAA command allows the contents of the gyroscope registers in the demonstration kit board to be read. AA, expressed as hexadecimal value and written in upper case, represents the address of the register to be read.

Once the read command is issued, the board returns GRAAhDDh, where AA is the address sent by the user and DD is the data present in the register.

For example, to read the register at address 0x20, the user issues the command *gr20, which returns, e.g., GR20hC7h.

Gyroscope register write

The *gwAADD command allows writing to the contents of the gyroscope registers in the demonstration kit board. AA and DD, expressed as hexadecimal values and written in upper case, represent, respectively, the address of the register and the data to be written. To write 0xC7 to the register at address 0x20, for example, the user issues the command *gw20C7.

Magnetometer register read

The *mrAA command allows the contents of the magnetometer registers in the demonstration kit board to be read. AA, expressed as a hexadecimal value and written in upper case, represents the address of the register to be read.

Once the read command is issued, the board returns MRAAhDDh, where AA is the address sent by the user and DD is the data present in the register.

For example, to read the register at address 0x00, the user issues the command *mr00, which returns, e.g., MR00h10h.

Magnetometer register write

The *mwAADD command allows writing to the contents of the magnetometer registers in the demonstration kit board. AA and DD, expressed as hexadecimal values and written in upper case, represent, respectively, the address of the register and the data to be written. To write 0x20 to the register at address 0x01, for example, the user issues the command *mw0120.

Pressure sensor register read

The *prAA command allows the contents of the pressure sensor registers in the demonstration kit board to be read. AA, expressed as a hexadecimal value and written in upper case, represents the address of the register to be read.

Once the read command is issued, the board returns PRAAhDDh, where AA is the address sent by the user and DD is the data present in the register.

For example, to read the register at address 0x20, the user issues the command *pr20, which returns, e.g., PR20h10h.

Pressure sensor register write

The *pwAADD command allows writing to the contents of the pressure sensor registers in the demonstration kit board. AA and DD, expressed as hexadecimal values and written in upper case, represent, respectively, the address of the register and the data to be written. To write 0xC7 to the register at address 0x20, for example, the user issues the command *pw20C7.

Humidity sensor register read

The *hrAA command allows the contents of the humidity sensor registers in the demonstration kit board to be read. AA, expressed as a hexadecimal value and written in upper case, represents the address of the register to be read.

Once the read command is issued, the board returns HRAAhDDh, where AA is the address sent by the user and DD is the data present in the register.

For example, to read the register at address 0x20, the user issues the command `*hr20`, which returns, e.g., `HR20h10h`.

Humidity sensor register write

The `*hwAADD` command allows writing to the contents of the humidity sensor registers in the demonstration kit board. AA and DD, expressed as hexadecimal values and written in upper case, represent, respectively, the address of the register and the data to be written. To write 0xC7 to the register at address 0x20, for example, the user issues the command `*hw20C7`.

Single acquisition

The `*single` command may be used to read just one set of data. It requires the sensor to be well configured and once invoked, returns the read values of one data sample.

The format of the returned value is exactly the same as the `*debug` command ([Table 5. Returned values for *debug command](#)), in fact, the `*debug` command is used for continuous data acquisition purposes whereas a `*single` command returns just one set of data.

List

The `*list` command returns the list of MKI adapters supported by the firmware, printed in ASCII format.

Listdev

The `*listdev` command returns the list of devices supported by the firmware, printed in ASCII format.

Echo on

The `*echoon` command is used to activate the write command verbose mode. Once this command is launched, after every write command the firmware automatically performs also a read of the register just written. This function is useful to check if the write has succeeded. For instance, if the `*echoon` command is launched, after a `*w2027` it results `R2027`.

Echo off

The `*echooff` command stops the write command verbose mode.

Accelerometer FIFO reset enable

The `*fiforst` command enables the accelerometer FIFO reset mode. For more details see the AN3308 application note.

Accelerometer FIFO mode enable

The `*fifomde` command is used to enable the accelerometer FIFO mode. For more details see the AN3308 application note.

Accelerometer FIFO Stream mode enable

The `*fifostr` command is used to enable the accelerometer FIFO stream mode. For more details see the AN3308 application note.

Accelerometer Stream-to-FIFO mode enable

The `*fifostf` command enables the accelerometer Stream-to-FIFO mode. For more details see the AN3308 application note.

Accelerometer Bypass-to-FIFO mode enable

The `*fifobtf` command is used to enable the accelerometer Bypass-to-FIFO mode.

Accelerometer Bypass-to-Stream mode enable

The `*fifobts` command is used to enable the accelerometer Bypass-to-Stream mode.

Accelerometer Dynamic Stream mode enable

The *fifodstr command enables the accelerometer Dynamic Stream mode.

Gyroscope FIFO reset enable

The *gfiforst command enables the gyroscope FIFO reset mode.

Gyroscope FIFO mode enable

The *gfifomde command is used to enable the gyroscope FIFO mode.

Gyroscope FIFO Stream mode enable

The *gfifostr command is used to enable the gyroscope FIFO stream mode.

Gyroscope Stream-to-FIFO mode enable

The *gfifostf command enables the gyroscope Stream-to-FIFO mode.

Gyroscope Bypass-to-FIFO mode enable

The *gfifobtf command is used to enable the gyroscope Bypass-to-FIFO mode.

Gyroscope Bypass-to-Stream mode enable

The *gfifobts command is used to enable the gyroscope Bypass-to-Stream mode.

Gyroscope Dynamic Stream mode enable

The *gfifodstr command enables the gyroscope Dynamic Stream mode.

Magnetometer FIFO reset enable

The *mfiforst command enables the magnetometer FIFO reset mode.

Magnetometer FIFO mode enable

The *mfifomde command is used to enable the magnetometer FIFO mode.

Magnetometer FIFO Stream mode enable

The *mfifostr command is used to enable the magnetometer FIFO stream mode.

Magnetometer Stream-to-FIFO mode enable

The *mfifostf command enables the magnetometer Stream-to-FIFO mode.

Magnetometer Bypass-to-FIFO mode enable

The *mfifobtf command is used to enable the magnetometer Bypass-to-FIFO mode.

Magnetometer Bypass-to-Stream mode enable

The *mfifobts command is used to enable the magnetometer Bypass-to-Stream mode.

Magnetometer Dynamic Stream mode enable

The *mfifodstr command enables the magnetometer Dynamic Stream mode.

Pressure sensor FIFO reset enable

The *pfiforst command enables the pressure sensor FIFO reset mode.

Pressure sensor FIFO mode enable

The *pfifomde command is used to enable the pressure sensor FIFO mode.

Pressure sensor FIFO Stream mode enable

The *pfifostr command is used to enable the pressure sensor FIFO stream mode.

Pressure sensor Stream-to-FIFO mode enable

The *pfifostf command enables the pressure sensor Stream-to-FIFO mode.

Pressure sensor Bypass-to-FIFO mode enable

The *pfifobtf command is used to enable the pressure sensor Bypass-to-FIFO mode.

Pressure sensor Bypass-to-Stream mode enable

The *pfifobts command is used to enable the pressure sensor Bypass-to-Stream mode.

Pressure sensor Dynamic Stream mode enable

The *pfifodstr command enables the pressure sensor Dynamic Stream mode.

PDON and PDOFF

The *PDON and *PDOFF commands are employed respectively to set to 1, and to clear to 0, the “power-down” pin in analog devices.

STON and STOFF

The *STON and *STOFF commands are employed respectively to set to 1, and to clear to 0, the “self test” pin in analog devices.

HPON and HPOFF

The *HPON and *HPOFF commands are employed respectively to set to 1, and to clear to 0, the “high-pass filter” pin in analog devices.

FSON and FSOFF

The *FSON and *FSOFF commands are employed respectively to set to 1 and to clear to 0 the “full scale” pin in analog devices.

4.2.2 Digital output accelerometers: supported commands

Table 6. Digital output accelerometers: supported commands list below lists the commands supported by the devices/demonstration boards including a digital output accelerometer.

Table 6. Digital output accelerometers: supported commands list

Command	Description	Returned value
*setdbXXXVY	Selects firmware according to the adapter connected	
*start	Starts continuous data acquisition	(see Table 4. Returned values for *start command)
*debug	Returns the output data in readable text format	(see Table 5. Returned values for *debug command)
*stop	Stops data acquisition	
*Zon	Forces 3-state	
*Zoff	Exits from 3-state	
*dev	Device name	e.g.: LIS3DH
*ver	Firmware version	e.g.: V1.0
*rAA	Accelerometer register read	e.g.: RAAhDDh
*wAADD	Accelerometer register write	
*single	It gets a single X, Y, and Z data acquisition	(see Table 5. Returned values for *debug command)
*list	Prints the list of MKIs supported	e.g.: MKI105V1
*listdev	Prints the list of devices supported	e.g.: LIS3DH
*echoon	Activates the write verbose mode	e.g.: RAAhDDh
*echooff	Deactivates the write verbose mode	
*fiforst ⁽¹⁾	Accelerometer "Reset mode" enable	st 0 0 0 0 0 0 IR FC FS
*fifomde ⁽¹⁾	Accelerometer "FIFO mode" enable	st 0 0 0 0 0 0 IR FC FS
*fifostr ⁽¹⁾	Accelerometer "FIFO Stream" enable	st 0 0 0 0 0 0 IR FC FS
*fifostf ⁽¹⁾	Accelerometer "Stream-to-FIFO" enable	st 0 0 0 0 0 0 IR FC FS
*fifobtf ⁽¹⁾	Accelerometer "Bypass-to-FIFO" enable	st 0 0 0 0 0 0 IR FC FS
*fifobts ⁽¹⁾	Accelerometer "Bypass-to-Stream" enable	st 0 0 0 0 0 0 IR FC FS
*fifodstr ⁽¹⁾	Accelerometer "Dynamic Stream" enable	st 0 0 0 0 0 0 IR FC FS

1. Available only for devices with embedded FIFO.

Note: IR: interrupt byte; FC: FIFO control register; FS: FIFO source register.

4.2.3 Analog output accelerometers: supported commands

Table 7. Analog output accelerometers: supported commands list below lists the commands supported by the devices/demonstration boards including an analog output accelerometer.

Table 7. Analog output accelerometers: supported commands list

Command	Description	Returned value
*setdbXXXVY	Selects firmware according to the adapter connected	
*start	Starts continuous data acquisition	(see Table 4. Returned values for *start command)
*debug	Returns the output data in readable text format	(see Table 5. Returned values for *debug command)
*stop	Stops data acquisition	
*Zon	Forces 3-state	
*Zoff	Exits from 3-state	
*dev	Device name	e.g.: LIS3DH
*ver	Firmware version	e.g.: V1.0
*single	It gets a single X, Y, and Z data acquisition	(see Table 5. Returned values for *debug command)
*list	Prints the list of MKIs supported	e.g.: MKI105V1
*listdev	Prints the list of devices supported	e.g.: LIS3DH
*echoon	Activates the write verbose mode	e.g.: RAAhDDh
*echooff	Deactivates the write verbose mode	
*PDON	Sets power-down pin	
*PDOFF	Clears power-down pin	
*STON	Sets self-test pin	
*STOFF	Clears self-test pin	
*FSON	Sets full-scale pin	
*FSOFF	Clears full-scale pin	

4.2.4 Digital output gyroscopes: supported commands

Table 8. Digital output gyroscopes: supported commands list below lists the commands supported by the devices/ demonstration boards including a digital output gyroscope.

Table 8. Digital output gyroscopes: supported commands list

Command	Description	Returned value
*setdbXXXVY	Selects firmware according to the adapter connected	
*start	Starts continuous data acquisition	(see Table 4. Returned values for *start command)
*debug	Returns the output data in readable text format	(see Table 5. Returned values for *debug command)
*stop	Stops data acquisition	
*Zon	Forces 3-state	
*Zoff	Exits from 3-state	
*dev	Device name	e.g.: LIS3DH
*ver	Firmware version	e.g.: V1.0
*grAA	Gyroscope register read	e.g.: GRAAhDDh
*gWAADD	Gyroscope register write	
*single	It gets a single X, Y, and Z data acquisition	(see Table 5. Returned values for *debug command)
*list	Prints the list of MKIs supported	e.g.: MKI105V1
*listdev	Prints the list of devices supported	e.g.: LIS3DH
*echoon	Activates the write verbose mode	e.g.: RAAhDDh
*echooff	Deactivates the write verbose mode	
*gfiforst ⁽¹⁾	Gyroscope "Reset mode" enable	st 0 0 0 0 0 0 IR FC FS
*gfifomde ⁽¹⁾	Gyroscope "FIFO mode" enable	st 0 0 0 0 0 0 IR FC FS
*gfifostr ⁽¹⁾	Gyroscope "FIFO Stream" enable	st 0 0 0 0 0 0 IR FC FS
*gfifostf ⁽¹⁾	Gyroscope "Stream-to-FIFO" enable	st 0 0 0 0 0 0 IR FC FS
*gfifobtf ⁽¹⁾	Gyroscope "Bypass-to-FIFO" enable	st 0 0 0 0 0 0 IR FC FS
*gfifobts ⁽¹⁾	Gyroscope "Bypass-to-Stream" enable	st 0 0 0 0 0 0 IR FC FS
*gfifodstr ⁽¹⁾	Gyroscope "Dynamic Stream" enable	st 0 0 0 0 0 0 IR FC FS

1. Available only for devices with embedded FIFO.

Note: IR: interrupt byte; FC: FIFO control register; FS: FIFO source register.

4.2.5 Analog output gyroscopes: supported commands

Table 9. Analog output gyroscopes: supported commands list below lists the commands supported by the devices/demonstration boards including an analog output gyroscope.

Table 9. Analog output gyroscopes: supported commands list

Command	Description	Returned value
*setdbXXXVY	Selects firmware according to the adapter connected	
*start	Starts continuous data acquisition	(see Table 4. Returned values for *start command)
*debug	Returns the output data in readable text format	(see Table 5. Returned values for *debug command)
*stop	Stops data acquisition	
*Zon	Forces 3-state	
*Zoff	Exits from 3-state	
*dev	Device name	e.g.: LIS3DH
*ver	Firmware version	e.g.: V1.0
*single	It gets a single X, Y, and Z data acquisition	(see Table 5. Returned values for *debug command)
*list	Prints the list of MKIs supported	e.g.: MKI105V1
*listdev	Prints the list of devices supported	e.g.: LIS3DH
*echoon	Activates the write verbose mode	e.g.: RAAhDDh
*echooff	Deactivates the write verbose mode	
*PDON	Sets power-down pin	
*PDOFF	Clears power-down pin	
*STON	Sets self-test pin	
*STOFF	Clears self-test pin	
*HPON	Sets high-pass filter pin	
*HPOFF	Clears high-pass filter pin	

4.2.6 Digital output magnetometers: supported commands

Table 10. Digital output magnetometers: supported commands list below lists the commands supported by the devices/demonstration boards including a digital output magnetometer.

Table 10. Digital output magnetometers: supported commands list

Command	Description	Returned value
*setdbXXXVY	Selects firmware according to the adapter connected	
*start	Starts continuous data acquisition	(see Table 4. Returned values for *start command)
*debug	Returns the output data in readable text format	(see Table 5. Returned values for *debug command)
*stop	Stops data acquisition	
*Zon	Forces 3-state	
*Zoff	Exits from 3-state	
*dev	Device name	e.g.: LIS3DH
*ver	Firmware version	e.g.: V1.0
*mrAA	Magnetometer register read	e.g.: MRAAhDDh
*mwAADD	Magnetometer register write	
*single	It gets a single X, Y, and Z data acquisition	(see Table 5. Returned values for *debug command)
*list	Prints the list of MKIs supported	e.g.: MKI105V1
*listdev	Prints the list of devices supported	e.g.: LIS3DH
*echoon	Activates the write verbose mode	e.g.: MRAAhDDh
*echooff	Deactivates the write verbose mode	
*mfiforst ⁽¹⁾	Magnetometer "Reset mode" enable	st 0 0 0 0 0 0 IR FC FS
*mfifomde ⁽¹⁾	Magnetometer "FIFO mode" enable	st 0 0 0 0 0 0 IR FC FS
*mfifostr ⁽¹⁾	Magnetometer "FIFO Stream" enable	st 0 0 0 0 0 0 IR FC FS
*mfifostf ⁽¹⁾	Magnetometer "Stream-to-FIFO" enable	st 0 0 0 0 0 0 IR FC FS
*mfifobtf ⁽¹⁾	Magnetometer "Bypass-to-FIFO" enable	st 0 0 0 0 0 0 IR FC FS
*mfifobts ⁽¹⁾	Magnetometer "Bypass-to-Stream" enable	st 0 0 0 0 0 0 IR FC FS
*mfifodstr ⁽¹⁾	Magnetometer "Dynamic Stream" enable	st 0 0 0 0 0 0 IR FC FS

1. Available only for devices with embedded FIFO.

4.2.7 Digital output pressure sensors: supported commands

Table 11. Digital output pressure sensors: supported commands list below lists the commands supported by the devices/demonstration boards including a digital output pressure sensor.

Table 11. Digital output pressure sensors: supported commands list

Command	Description	Returned value
*setdbXXXVY	Selects firmware according to the adapter connected	
*start	Starts continuous data acquisition	(see Table 4. Returned values for *start command)
*debug	Returns the output data in readable text format	(see Table 5. Returned values for *debug command)
*stop	Stops data acquisition	
*Zon	Forces 3-state	
*Zoff	Exits from 3-state	
*dev	Device name	e.g.: LIS3DH
*ver	Firmware version	e.g.: V1.0
*prAA	Pressure sensor register read	e.g.: PRAAhDDh
*pwAADD	Pressure sensor register write	
*single	It gets a single X, Y, and Z data acquisition	(see Table 5. Returned values for *debug command)
*list	Prints the list of MKIs supported	e.g.: MKI105V1
*listdev	Prints the list of devices supported	e.g.: LIS3DH
*echoon	Activates the write verbose mode	e.g.: PRAAhDDh
*echooff	Deactivates the write verbose mode	
*pfiforst ⁽¹⁾	Pressure sensor "Reset mode" enable	st 0 0 0 0 0 0 IR FC FS
*pfifomde ⁽¹⁾	Pressure sensor "FIFO mode" enable	st 0 0 0 0 0 0 IR FC FS
*pfifostr ⁽¹⁾	Pressure sensor "FIFO Stream" enable	st 0 0 0 0 0 0 IR FC FS
*pfifostf ⁽¹⁾	Pressure sensor "Stream-to-FIFO" enable	st 0 0 0 0 0 0 IR FC FS
*pfifobtf ⁽¹⁾	Pressure sensor "Bypass-to-FIFO" enable	st 0 0 0 0 0 0 IR FC FS
*pfifobts ⁽¹⁾	Pressure sensor "Bypass-to -Stream" enable	st 0 0 0 0 0 0 IR FC FS
*pfifodstr ⁽¹⁾	Pressure sensor "Dynamic Stream" enable	st 0 0 0 0 0 0 IR FC FS

1. Available only for devices with embedded FIFO.

4.2.8 Digital output humidity sensors: supported commands

Table 11. Digital output pressure sensors: supported commands list below lists the commands supported by the devices/demonstration boards including a digital output humidity sensor.

Table 12. Digital output humidity sensors: supported commands list

Command	Description	Returned value
*setdbXXXVY	Selects firmware according to the adapter connected	
*start	Starts continuous data acquisition	(see Table 4. Returned values for *start command)
*debug	Returns the output data in readable text format	(see Table 5. Returned values for *debug command)
*stop	Stops data acquisition	
*Zon	Forces 3-state	
*Zoff	Exits from 3-state	
*dev	Device name	e.g.: LIS3DH
*ver	Firmware version	e.g.: V1.0
*hrAA	Humidity sensor register read	e.g.: HRAAhDDh
*hWAADD	Humidity sensor register write	
*single	It gets a single X, Y, and Z data acquisition	(see Table 5. Returned values for *debug command)
*list	Prints the list of MKIs supported	e.g.: MKI105V1
*listdev	Prints the list of devices supported	e.g.: LIS3DH
*echoon	Activates the write verbose mode	e.g.: PRAAhDDh
*echooff	Deactivates the write verbose mode	

4.3 Quick start

This section shows the basic sequence of commands, based on the LIS3DH accelerometer, to start a data communication session and to retrieve the X, Y, and Z acceleration data from the demonstration kit:

1. Connect the eMotion to the USB port
2. Start "Microsoft® HyperTerminal" and configure it as described in [Section 4.1 Getting started](#)
3. Inside the "HyperTerminal" window, enter the command *setdb105v1 (supposing the LIS3DH adapter board is used, for other adapters see the relevant datasheets to check the register configuration), enter the command *Zoff to enable the control of the device by the STM32F103RET6 microcontroller, and *w2047 to switch on the LIS3DH and to set the data rate to 50 Hz
4. Send the *debug command to get the X, Y, and Z data measured by the sensor
5. Send *stop to end the continuous acquisition and visualization.

5 Schematic diagrams

The schematic diagrams of the eMotion demonstration kit are shown in Figure 7. eMotion board (power supply and USB) and Figure 8. STEVAL-MK1109V2 eMotion board (STM32F103RET6 and connectors).

Figure 7. eMotion board (power supply and USB)

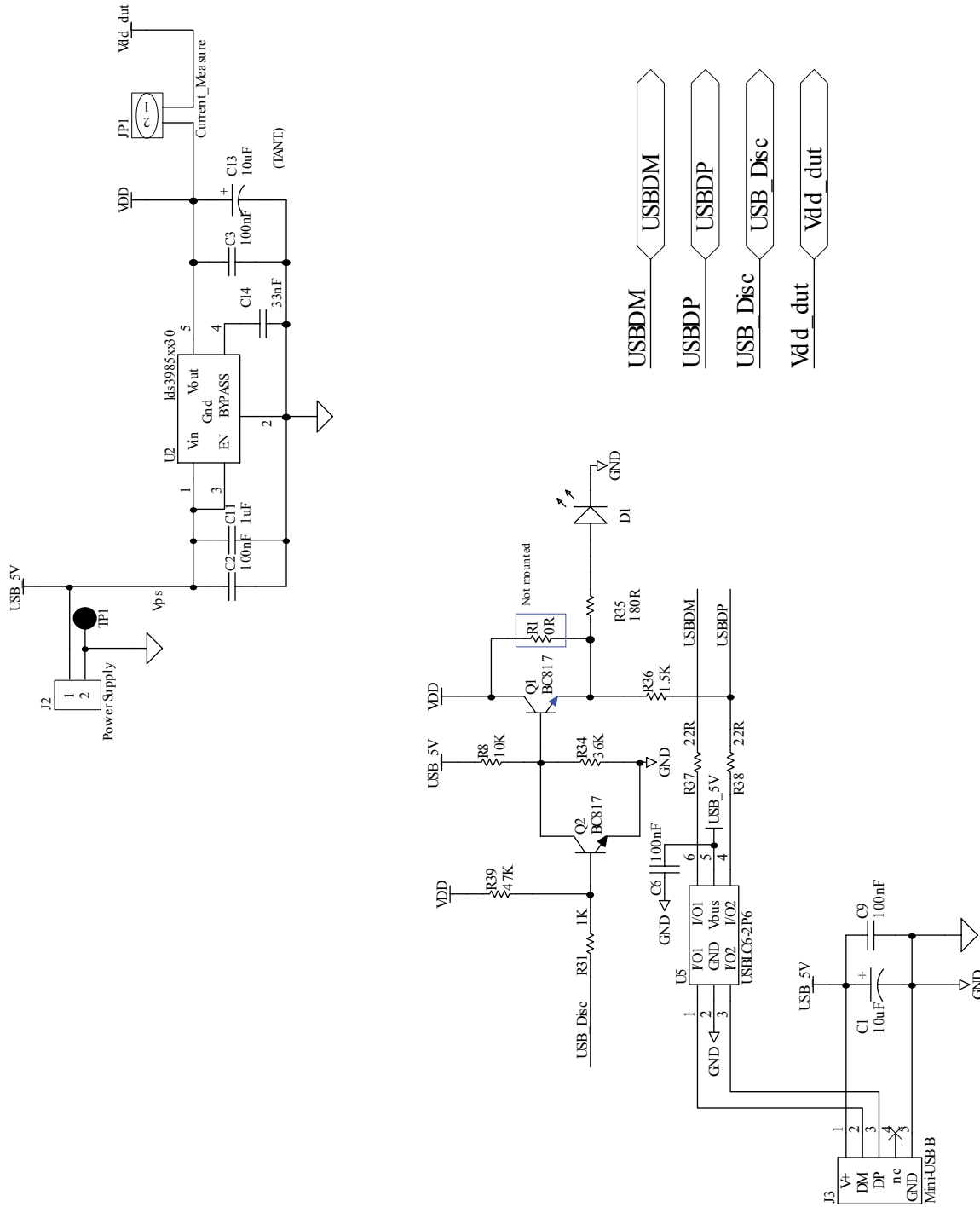
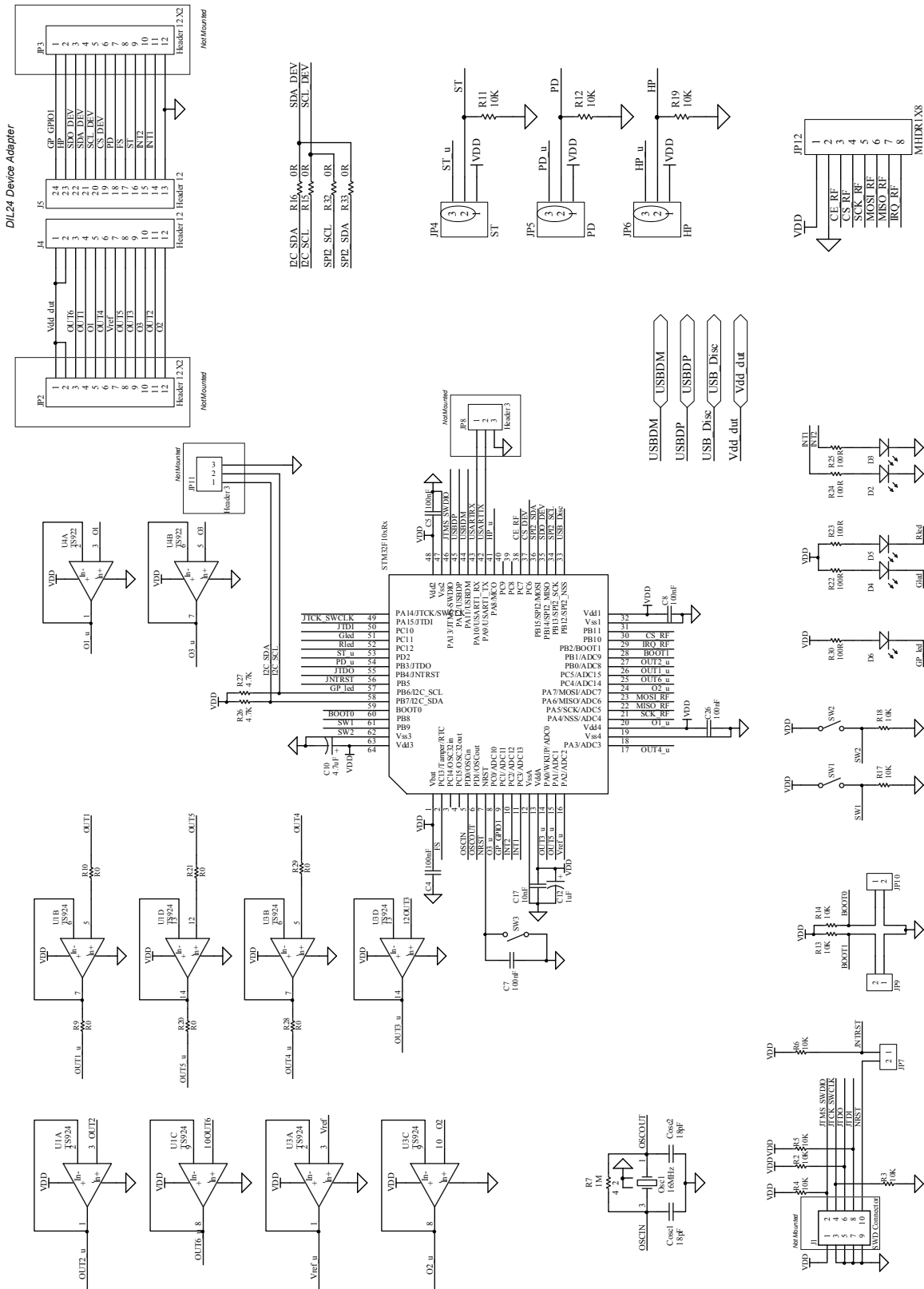

Figure 8. STEVAL-MK1109V2 eMotion board (STM32F103RET6 and connectors)

6 Bill of materials

The bill of materials for the eMotion demonstration kit is provided in [Table 13. Bill of materials for STEVAL-MKI109V2](#) below.

Table 13. Bill of materials for STEVAL-MKI109V2

Designator	Description	Comment	Footprint
C1	Capacitor	10 μ F	C1206_POL
C2	Capacitor	100 nF	0805
C3	Capacitor	100 nF	0805
C4	Capacitor	100 nF	0805
C5	Capacitor	100 nF	0805
C6	Capacitor	100 nF	0805
C7	Capacitor	100 nF	0805
C8	Capacitor	100 nF	0805
C9	Capacitor	100 nF	0805
C10	Capacitor	4.7 μ F	C0805_POL
C11	Capacitor	1 μ F	0805
C12	Capacitor	1 μ F	C0805_POL
C13	Capacitor	10 μ F	C0805_POL
C14	Capacitor	33 nF	0805
C17	Capacitor	10 nF	0805
C26	Capacitor	100 nF	0805
Cosc1	Capacitor	18 pF	0805
Cosc2	Capacitor	18 pF	0805
D1	SMD LED	Blue LED	0805
D2	SMD LED	Green LED	0805
D3	SMD LED	Orange LED	0805
D4	SMD LED	Green LED	0805
D5	SMD LED	Red LED	0805
D6	SMD LED	Orange LED	0805
J1	Header_HE10_5X2	JTAG/SWD connector	HDR5X2 1.27 mm
J2	CON2	Power supply	Header 1x2 2 mm
J3	USB_mini_B	Mini-USB B	USB_mini_B
J4	Header 12	Header 12	HDR1X12
J5	Header 12	Header 12	JP 1X12
JP1	CON2	Current_Measure	Header 1x2 2 mm
JP2	Header 12	Header 12X2	HDR1X12
JP3	Header 12	Header 12X2	HDR1X12
JP4	Header 3	STMicroelectronics	Header 1x3 2 mm
JP5	Header 3	PD	Header 1x3 2 mm
JP6	Header 3	HP	Header 1x3 2 mm

Designator	Description	Comment	Footprint
JP7	CON2		Header 1x2 2 mm
JP9	CON2		Header 1x2 2 mm
JP10	CON2		Header 1x2 2 mm
Osc1	Ceramic SMD crystal 3.2X2.5 mm	16 MHz	Ceramic SMD Crystal 3.2x2.5 mm
Q1	BC817-25	BC817	SOT-23
Q2	BC817-25	BC817	SOT-23
R2	Resistor	10 kΩ	0805
R3	Resistor	10 kΩ	0805
R4	Resistor	10 kΩ	0805
R5	Resistor	10 kΩ	0805
R6	Resistor	10 kΩ	0805
R7	Resistor	1 MΩ	0805
R8	Resistor	10 kΩ	0805
R9	Resistor	0 Ω	0805
R10	Resistor	0 Ω	0805
R11	Resistor	10 kΩ	0805
R12	Resistor	10 kΩ	0805
R13	Resistor	10 kΩ	0805
R14	Resistor	10 kΩ	0805
R15	Resistor	0 Ω	0805
R16	Resistor	0 Ω	0805
R17	Resistor	10 kΩ	0805
R18	Resistor	10 kΩ	0805
R19	Resistor	10 kΩ	0805
R20	Resistor	0 Ω	0805
R21	Resistor	0 Ω	0805
R22	Resistor	100 Ω	0805
R23	Resistor	100 Ω	0805
R24	Resistor	100 Ω	0805
R25	Resistor	100 Ω	0805
R26	Resistor	4.7 kΩ	0805
R27	Resistor	4.7 kΩ	0805
R28	Resistor	0 Ω	0805
R29	Resistor	0 Ω	0805
R30	Resistor	100 Ω	0805
R31	Resistor	1 kΩ	0805
R32	Resistor	0 Ω	0805
R33	Resistor	0 Ω	0805
R34	Resistor	36 kΩ	0805
R35	Resistor	180 Ω	0805

Designator	Description	Comment	Footprint
R36	Resistor	1.5 kΩ	0805
R37	Resistor	22 Ω	0805
R38	Resistor	22 Ω	0805
R39	Resistor	47 kΩ	0805
SW1	SMT SWITCH		
SW2	SMT SWITCH		
SW3	SMT SWITCH		
U1	TS924	TS924	TS924
U2	Component_1	lds3985xx30	SOT23-5
U3	TS924	TS924	TS924
U4	TS922	TS922	SO8_2
U5	USBLC6-2P6	USBLC6-2P6	SOT-666
U6	STM32F103RET6		LQF64

Revision history

Table 14. Document revision history

Date	Revision	Changes
02-Mar-2011	1	Initial release
18-Apr-2012	2	<ul style="list-style-type: none"> Added: STEVAL-MKI109V2 Modified: Bill of materials for STEVAL-MKI109V2 Added new supported demo kits. Updated Table 2: List of supported MEMS adapter boards, Table 4: Returned values for *start command and Table 5: Returned values for *debug command.
09-Sep-2013	3	Updated: Section 2.2: DFU, Table 2: List of supported MEMS adapter boards, Table 4: Returned values for *start command and Table 5: Returned values for *debug command.
03-Nov-2014	4	<p>Updated: Section 2.1: Hardware installation (Windows platforms), Table 2: List of supported MEMS adapter boards, Table 4: Returned values for *start command, and Table 5: Returned values for *debug command</p> <p>Added: Section 2.2.2: DFU on Linux, Section 2.2.3: DFU on Mac OS, and Section 4.2.8: Digital output humidity sensor: supported commands</p> <p>Removed: STEVAL-MKI109V1</p>
20-Oct-2016	5	<p>Added Figure 4: How to connect the DIL24 adapter board to the STEVAL-MKI109V2</p> <p>Updated version of VCP Driver to V.1.4.0 in Section 2.1: Hardware installation (Windows platforms)</p> <p>Updated reference to version of firmware in use to lower than V3.0.0 in Section 2.2: DFU</p> <p>Updated version of DFU software to V3.0.5 in Section 2.2.1: DFU on Windows</p> <p>Updated Table 2: List of supported MEMS adapter boards</p> <p>Updated Table 4: Returned values for *start command</p> <p>Updated Table 5: Returned values for *debug command</p>
05-Feb-2018	6	<p>Updated Table 2. List of supported MEMS adapter boards</p> <p>Updated Table 4. Returned values for *start command</p>

Contents

1	Demonstration kit description	2
2	eMotion board installation	7
2.1	Hardware installation (Windows platforms).....	7
2.2	DFU	8
2.2.1	DFU on Windows	8
2.2.2	DFU on Linux	9
2.2.3	DFU on Mac OS	9
3	Supported MEMS adapter boards	10
4	Supported commands	12
4.1	Getting started	12
4.2	Supported commands	13
4.2.1	Commands list and description	13
4.2.2	Digital output accelerometers: supported commands.....	23
4.2.3	Analog output accelerometers: supported commands	24
4.2.4	Digital output gyroscopes: supported commands	25
4.2.5	Analog output gyroscopes: supported commands	26
4.2.6	Digital output magnetometers: supported commands.....	27
4.2.7	Digital output pressure sensors: supported commands	28
4.2.8	Digital output humidity sensors: supported commands.....	29
4.3	Quick start.....	29
5	Schematic diagrams	30
6	Bill of materials	32
	Revision history	35

List of tables

Table 1.	Jumper configuration for power-down (PD), self test (ST), and high-pass filter reset (HP)	5
Table 2.	List of supported MEMS adapter boards	10
Table 3.	Supported commands list	13
Table 4.	Returned values for *start command.	15
Table 5.	Returned values for *debug command	17
Table 6.	Digital output accelerometers: supported commands list	23
Table 7.	Analog output accelerometers: supported commands list	24
Table 8.	Digital output gyroscopes: supported commands list.	25
Table 9.	Analog output gyroscopes: supported commands list	26
Table 10.	Digital output magnetometers: supported commands list	27
Table 11.	Digital output pressure sensors: supported commands list	28
Table 12.	Digital output humidity sensors: supported commands list	29
Table 13.	Bill of materials for STEVAL-MKI109V2.	32
Table 14.	Document revision history	35

List of figures

Figure 1.	Demonstration board block diagram	2
Figure 2.	Top silkscreen of the eMotion kit	3
Figure 3.	Board top view	4
Figure 4.	How to connect the DIL24 adapter board to the STEVAL-MKI109V2	6
Figure 5.	Notification message	7
Figure 6.	Virtual COM port assignment	8
Figure 7.	eMotion board (power supply and USB)	30
Figure 8.	STEVAL-MKI109V2 eMotion board (STM32F103RET6 and connectors)	31

IMPORTANT NOTICE – PLEASE READ CAREFULLY

STMicroelectronics NV and its subsidiaries (“ST”) reserve the right to make changes, corrections, enhancements, modifications, and improvements to ST products and/or to this document at any time without notice. Purchasers should obtain the latest relevant information on ST products before placing orders. ST products are sold pursuant to ST’s terms and conditions of sale in place at the time of order acknowledgement.

Purchasers are solely responsible for the choice, selection, and use of ST products and ST assumes no liability for application assistance or the design of Purchasers’ products.

No license, express or implied, to any intellectual property right is granted by ST herein.

Resale of ST products with provisions different from the information set forth herein shall void any warranty granted by ST for such product.

ST and the ST logo are trademarks of ST. All other product or service names are the property of their respective owners.

Information in this document supersedes and replaces information previously supplied in any prior versions of this document.

© 2018 STMicroelectronics – All rights reserved