

# SMT Power Inductors

Power Beads - PA051XNL, PA121XNL, PA151XNL Series



- ⚙️ **Current Rating:** Over 70A<sub>pk</sub>
- ⚙️ **Inductance Range:** 72nH to 470nH
- ⚙️ **Four Package Sizes:**

PA0512/PA1212: 7.0 x 7.0 x 4.96mm Max  
 PA0511/PA1211: 10.2 x 7.0 x 4.96mm Max  
 PA0515: 11.2 x 11.2 x 9.0mm Max  
 PA0513/PA1513: 13.5 x 13.0 x 8.0mm Max

Electrical Specifications @ 25°C - Operating Temperature -40°C to +130°C <sup>7,8</sup>

Part Number	Inductance @ 0A <sub>DC</sub> (nH ±20%)	Inductance @ I <sub>rated</sub> (nH TYP)	I <sub>rated</sub> <sup>1</sup> (A <sub>DC</sub> )	DCR <sup>2</sup> (mΩ)	Saturation Current <sup>3</sup> (TYP)		Heating <sup>4</sup> Current (A TYP)
					25°C	100°C	
<b>PA0512NL and PA1212NL - 7.0mm x 7.0mm x 4.96mm Max</b>							
PA0512.700NLT	72	72	31	0.32 ±9.4%	58	45	31
PA0512.101NLT	105	102	31		46	38	
PA0512.151NLT	150	134	24		30	24	
PA1212.700NLT	72	72	31	0.46 ±6.5%	58	45	31
PA1212.101NLT	105	102	31		46	38	
PA1212.151NLT	150	134	24		30	24	
<b>PA0511NL and PA1211NL - 10.2mm x 7.0mm x 4.96mm Max</b>							
PA0511.850NLT	85	85	31	0.39 ±7.7%	70+	70	31
PA0511.900NLT	100	100	31		70	65	
PA0511.101NLT	120	120	31		52	42	
PA0511.151NLT	155	150	31		40	36	
PA0511.221NLT	220	176	25		33	25	
PA1211.850NLT *	85	85	31	0.55 ±7.3%	70+	70	31
PA1211.900NLT *	100	100	31		70	65	
PA1211.101NLT	120	120	31		52	42	
PA1211.151NLT	155	150	31		40	36	
PA1211.221NLT	220	176	25		33	25	
<b>PA0515NL - 11.2mm x 11.2mm x 9.0mm Max</b>							
PA0515.221NLT	225	225	35	0.63 ±9.5%	68	59	35
PA0515.271NLT	270	280	35		50	44	
PA0515.321NLT	325	325	35		43	36	
PA0515.471NLT	470	380	23		30	23	

# SMT Power Inductors

Power Beads - PA051XNL, PA121XNL, PA151XNL Series



Electrical Specifications @ 25°C - Operating Temperature -40°C to +130°C <sup>7,8</sup>

Part Number	Inductance @ $I_{A_{DC}}$ (nH $\pm 20\%$ )	Inductance @ $I_{rated}$ (nH TYP)	$I_{rated}^1$ (A <sub>DC</sub> )	DCR <sup>2</sup> (m $\Omega$ )	Saturation Current <sup>3</sup> (TYP)		Heating <sup>4</sup> Current (A TYP)
					25°C	100°C	
PA0513NL and PA1513NL - 13.5mm x 13.0mm x 8.0mm Max							
PA0513.211NLT	210	210	45	0.32 $\pm 9.4\%$	71	64	45
PA0513.261NLT	260	260	45		60	55	
PA0513.321NLT	320	285	41		50	45	
PA0513.441NLT	440	363	30		35	30	
PA1513.211NLT	210	210	45	0.53 $\pm 11.3\%$	71	64	45
PA1513.261NLT	260	260	45		60	55	
PA1513.321NLT	320	285	41		50	45	
PA1513.441NLT	440	363	30		35	30	

- Notes:**
- The rated current as listed is either the saturation current or the heating current depending on which value is lower.
  - The nominal DCR tolerance is by design. The nominal DCR is measured from point (a) to point (b), as shown below on the mechanical drawing.
  - The saturation current is the typical current which causes the inductance to drop by 20% at the stated ambient temperatures (25°C and 100°C). This current is determined by placing the component in the specified ambient environment and applying a short duration pulse current (to eliminate self-heating effects) to the component.
  - The heating current is the DC current which causes the part temperature to increase by approximately 40°C. This current is determined by soldering the component on a typical application PCB, and then applying the current to the device for 30 minutes without any forced air cooling.
  - In high volt\*time applications, additional heating in the component can occur due to core losses in the inductor which may necessitate derating the current in order to limit the temperature rise of the component. To determine the approximate total losses (or temperature rise) for a given application, the coreloss and temperature rise curves can be used.
  - Pulse complies to industry standard tape and reel specification EIA481.
  - The temperature of the component (ambient plus temperature rise) must be within the stated operating temperature range.
  - For part marking only the PA0513 series has the name 'Pulse' marked on the part. Due to component size, the remaining series' of parts are marked only with the Pulse PN, Date Code and Country of Origin.
- \* Contact Pulse for availability

## Mechanical

## Schematic

PAXXXX.XXXNLT

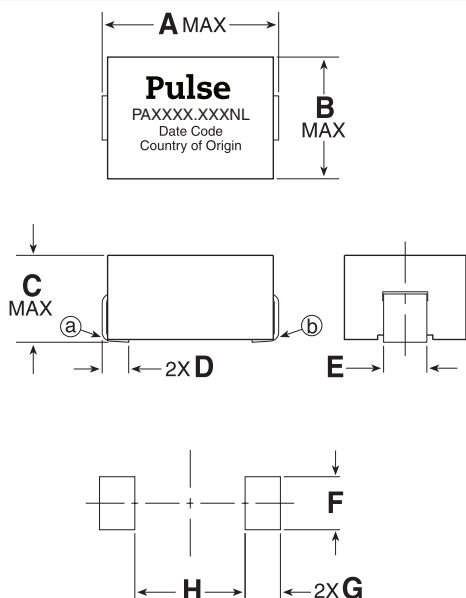

Dimensions: Inches  
mm  
Unless otherwise specified,  
all tolerances are:  $\pm \begin{matrix} .010 \\ 0.25 \end{matrix}$

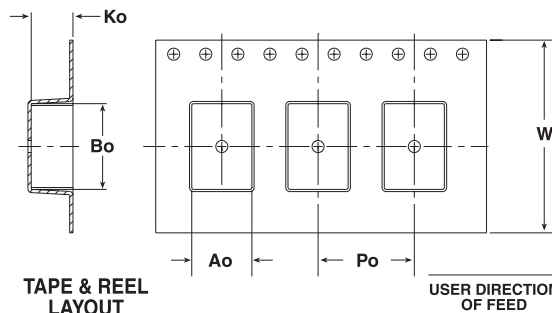
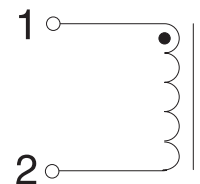

### SUGGESTED PAD LAYOUT

# SMT Power Inductors

Power Beads - PA051XNL, PA121XNL, PA151XNL Series



## Dimensions (inches/mm)

Part Number	A (MAX)	B (MAX)	C (MAX)	D (NOM)	E (NOM)	F (NOM)	G (NOM)	H (NOM)	Ao	Bo	Ko	Po	W	Parts/Reel	Weight (grams)
PA0512/PA1212	.276 7,00	.276 7,00	.195 4,96	.060 1,52	.098 2,49	.120 3,05	.080 2,03	.130 3,30	.295 7,49	.300 7,62	.205 5,21	.472 12,00	.630 16,00	1000	0.94
PA0511/PA1211	.400 10,20	.276 7,00	.195 4,96	.060 1,52	.098 2,49	.120 3,05	.080 2,03	.250 6,35	.295 7,49	.420 10,67	.205 5,21	.472 12,00	.945 24,00	1000	1.35
PA0515	.440 11,18	.440 11,18	.354 9,00	.100 2,54	.080 2,03	.100 2,54	.120 3,05	.210 5,33	.453 11,50	.453 11,50	.378 9,60	.945 24,00	.945 24,00	250	4.5
PA0513/PA1513	.530 13,46	.510 12,95	.315 8,00	.100 2,54	.200 5,08	.300 7,62	.125 3,18	.280 7,11	.525 13,34	.525 13,34	.320 8,13	.630 16,00	.945 24,00	400	5.7

### PA0512NL & PA1212NL

Inductance vs Current

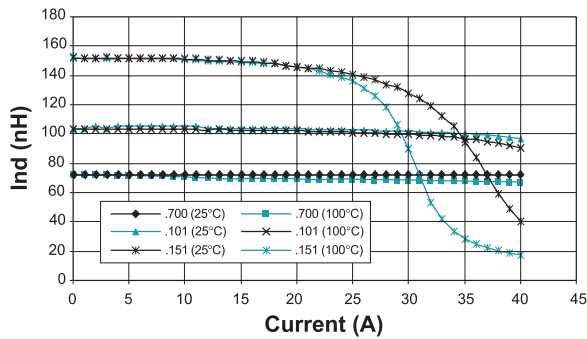

### PA0511NL & PA1211NL

Inductance vs Current

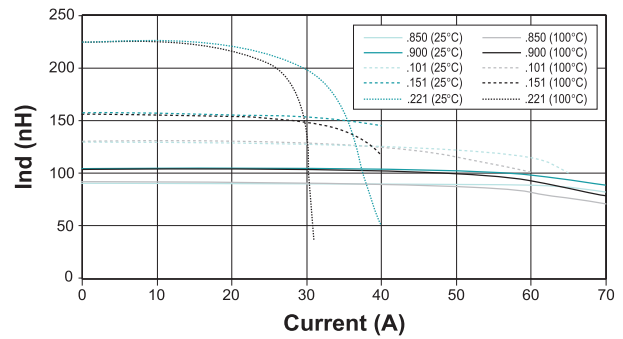

CoreLoss vs Flux Density

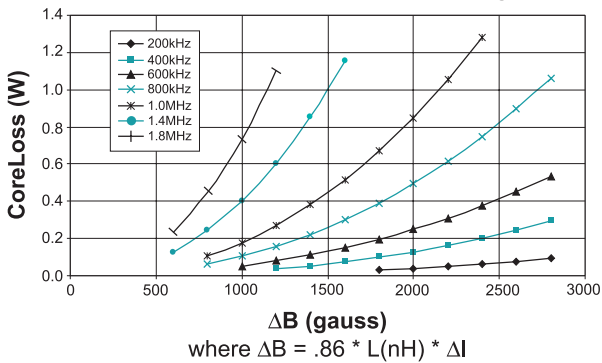

CoreLoss vs Flux Density

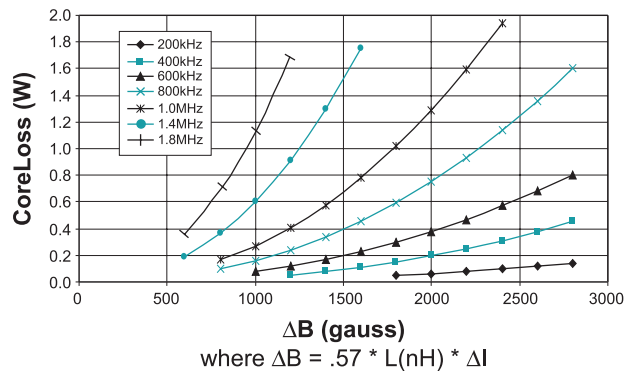

### Temp Rise vs Power Dissipation

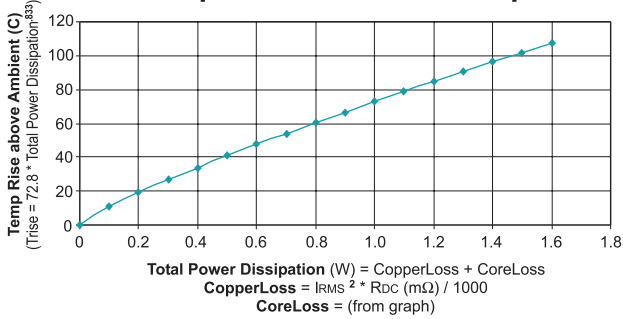

### Temp Rise vs Power Dissipation

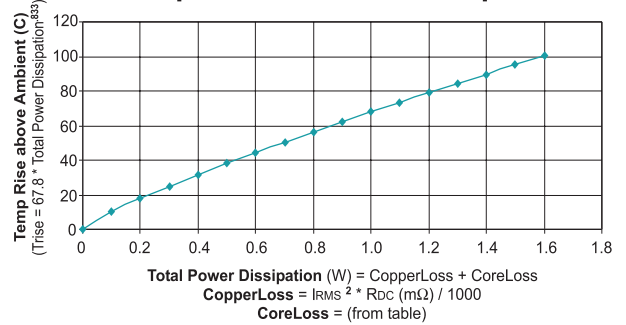

## Typical Inductance vs Current

### PA0513NL / PA1513NL

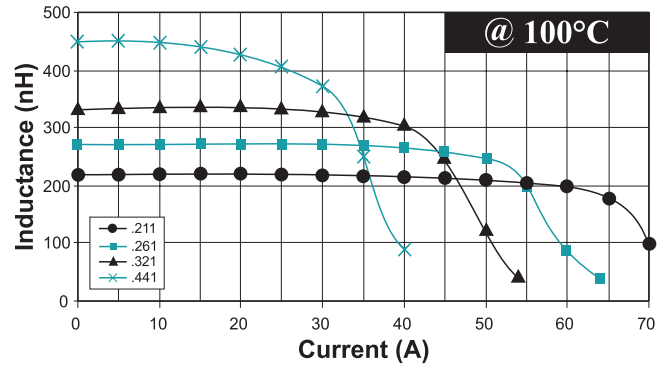
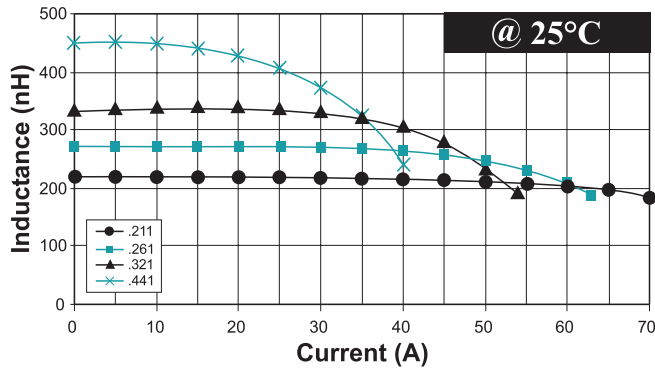

### CoreLoss vs Flux Density

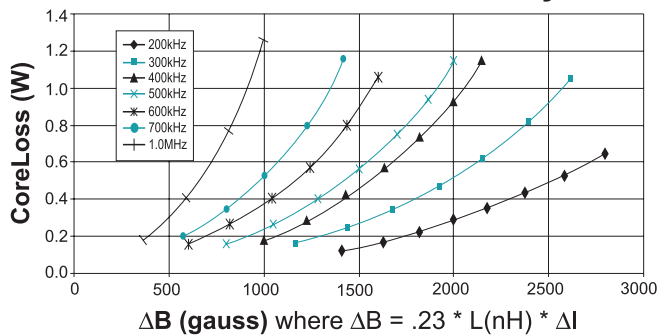

### Temp Rise vs Power Dissipation

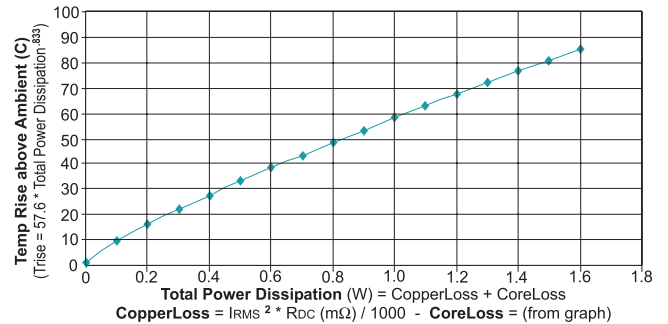

## Typical Inductance vs Current

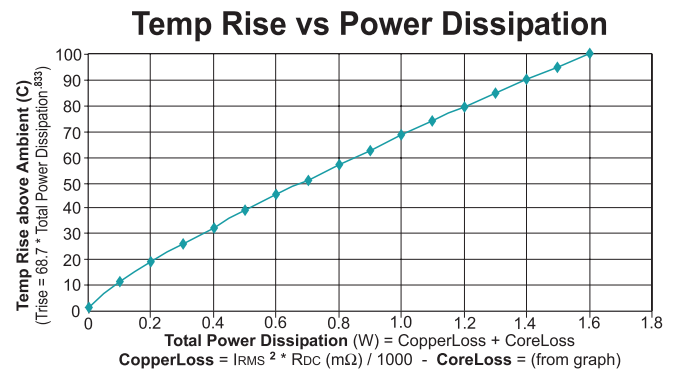
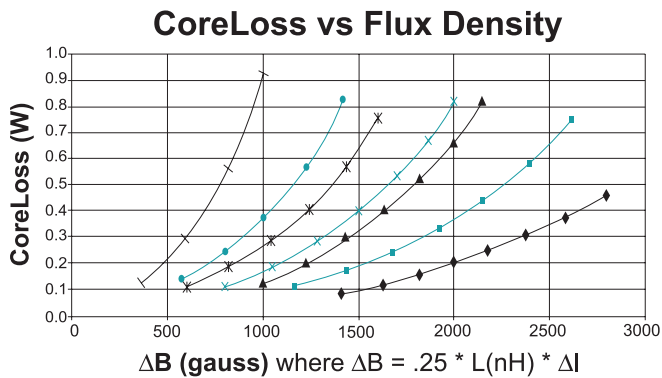
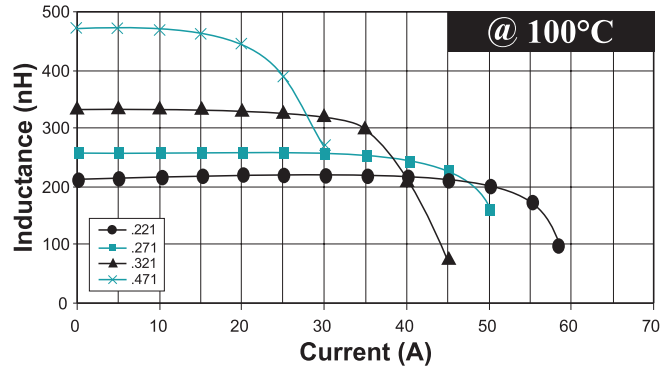
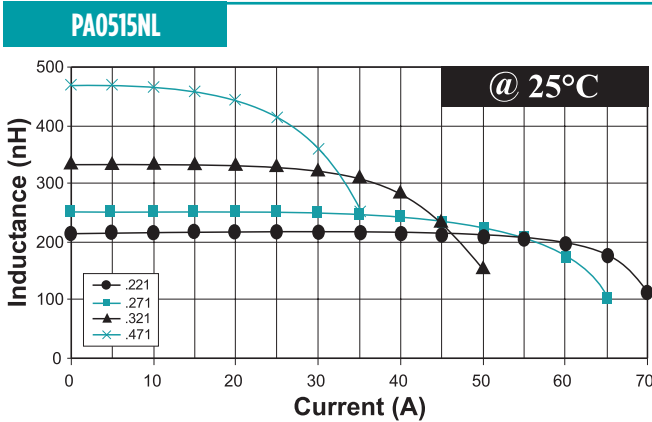

### For More Information

#### Pulse Worldwide Headquarters

15255 Innovation Drive Ste 100  
San Diego, CA 92128  
U.S.A.

#### Pulse Europe

Pulse Electronics GmbH  
Am Rottland 12  
58540 Meinerzhagen  
Germany

#### Pulse China Headquarters

Pulse Electronics (ShenZhen) CO., LTD  
D708, Shenzhen Academy of  
Aerospace Technology,  
The 10th Keji South Road,  
Nanshan District, Shenzhen,  
P.R. China 518057

#### Pulse North China

Room 2704/2705  
Super Ocean Finance Ctr.  
2067 Yan An Road West  
Shanghai 200336  
China

#### Pulse South Asia

3 Fraser Street 0428  
DUO Tower  
Singapore 189352

#### Pulse North Asia

1F., No.111 Xiyuan Road  
Zhongli District  
Taoyuan City 32057  
Taiwan (R.O.C)

Tel: 858 674 8100  
Fax: 858 674 8262

Tel: 49 2354 777 100  
Fax: 49 2354 777 168

Tel: 86 755 33966678  
Fax: 86 755 33966700

Tel: 86 21 62787060  
Fax: 86 2162786973

Tel: 65 6287 8998  
Fax: 65 6280 0080

Tel: 886 3 4356768  
Fax: 886 3 4356820

Performance warranty of products offered on this data sheet is limited to the parameters specified. Data is subject to change without notice. Other brand and product names mentioned herein may be trademarks or registered trademarks of their respective owners. © Copyright, 2019. Pulse Electronics, Inc. All rights reserved.