

PLEASE CHECK WWW.MOLEX.COM FOR LATEST PART INFORMATION

Part Number: [0351550600](#)
Status: **Active**
Description: 2.50mm Pitch Wire-to-Board Housing, Positive Lock, Natural, 6 Circuits

Documents:

3D Model	Product Specification PS-35184-001-001 (PDF)
3D Model (PDF)	Product Specification PS-68143-001-001 (PDF)
Drawing (PDF)	Packaging Specification 351550200-100 (PDF)
Product Specification PS-35155-001-001 (PDF)	Packaging Specification PK-35155-001-001 (PDF)
Product Specification PS-35155-002-001 (PDF)	RoHS Certificate of Compliance (PDF)

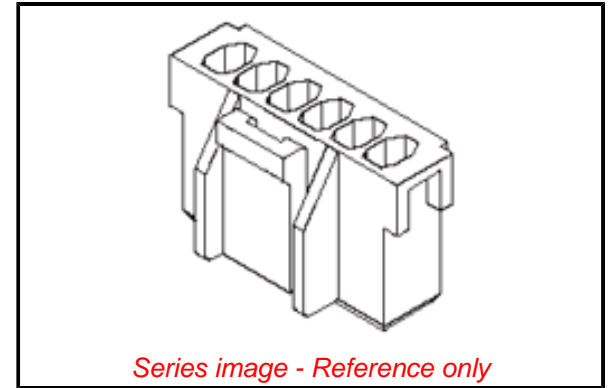

Agency Certification

CSA	LR19980
UL	E29179

General

Product Family	Crimp Housings
Series	35155
Application	Signal, Wire-to-Wire
Product Name	N/A
UPC	800754835336

Physical

Breakaway	No
Circuits (maximum)	6
Color - Resin	Natural
Flammability	94V-0
Gender	Receptacle
Glow-Wire Capable	No
Keying to Mating Part	None
Lock to Mating Part	Yes
Material - Resin	Polyester
Net Weight	0.666/g
Number of Rows	1
Packaging Type	Bag
Panel Mount	No
Pitch - Mating Interface	2.50mm
Pitch - Termination Interface	2.50mm
Temperature Range - Operating	-40° to +105°C

Material Info

Reference - Drawing Numbers

Packaging Specification	351550200-100, PK-35155-001-001
Product Specification	PS-35155-001-001, PS-35155-002-001, PS-35184-001-001, PS-68143-001-001
Sales Drawing	SD-35155-XX0X-001

EU ELV

Not Relevant

EU RoHS

Compliant

REACH SVHC

Not Contained Per -
D(2021)4569-DC (8
July 2021)

Halogen-Free

Status

Not Low-Halogen

For more information, please visit [Contact US](#)

China ROHS

ELV

RoHS Phthalates

China RoHS

Green Image

Not Relevant

Not Contained

Search Parts in this Series

[35155](#) Series

Mates With

[35312](#) Vertical Shrouded Header, [35184](#)
Wire-to-Wire Plug Housing

Use With

[5103](#) SPOX Crimp Terminal

Mouser Electronics

Authorized Distributor

Click to View Pricing, Inventory, Delivery & Lifecycle Information:

[Molex:](#)

[35155-0600](#)