

ARL2-1307URC

PACKAGE DIMENSIONS (mm):

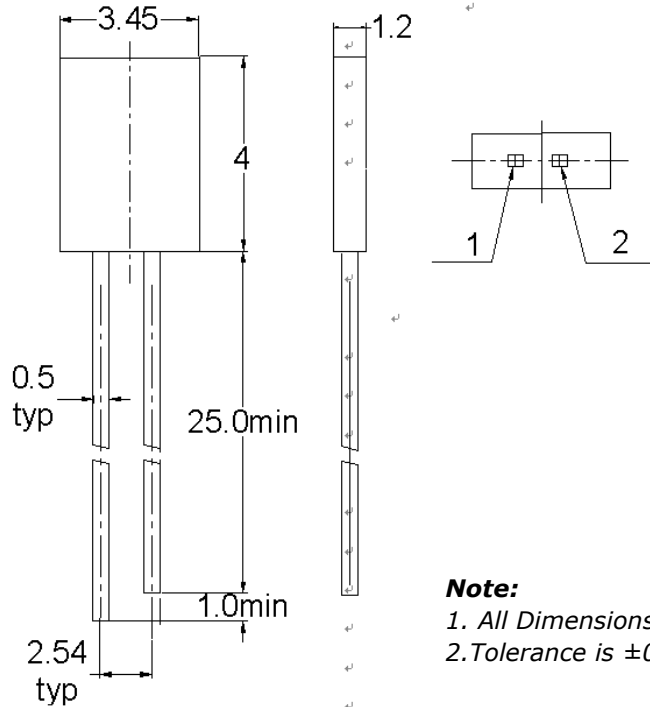

ABSOLUTE MAXIMUM RATINGS (Ta=25°C):

Items	Symbol	Absolute Maximum Rating	Unit
Power Dissipation	P_D	80	mW
Peak Forward Current 1/10 Duty Cycle, 0.1ms Pulse	I_{FP}	60	mA
Continuous Forward Current	I_F	30	mA
Reverse Voltage	V_R	5	V
Operation Temperature Range	T_{opr}	-40~+80	°C
Storage Temperature Range	T_{stg}	-25~+100	°C
Lead Soldering Temperature (4mm from Body)	T_{sol}	260°C for 5 Secods	

ELECTRICAL OPTICAL CHARACTERISTICS (Ta=25°C)

Items	Symbol	Condition	Min.	Typ.	Max.	Unit
Forward Voltage	V_F	$I_F=20\text{mA}$	1.9	--	2.4	V
Luminous Intensity	I_V	$I_F=20\text{mA}$	--	80	--	mcd
Dominant Wavelength	λ_d	$I_F=20\text{mA}$	620	625	630	nm
Spectral width at half height	$\Delta\lambda$	$I_F=20\text{mA}$	--	30	--	nm
Reverse Current	I_R	$V_R=5\text{V}$	--	--	10	μA
Viewing Angle	$2\theta_{1/2}$	$I_F=20\text{mA}$	--	120	--	deg

ELECTRONIC/OPTICAL CHARACTERISTICS CURVE:

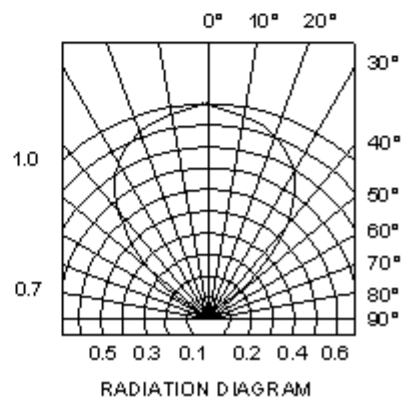
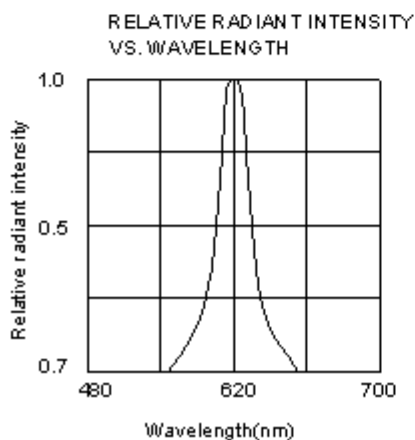
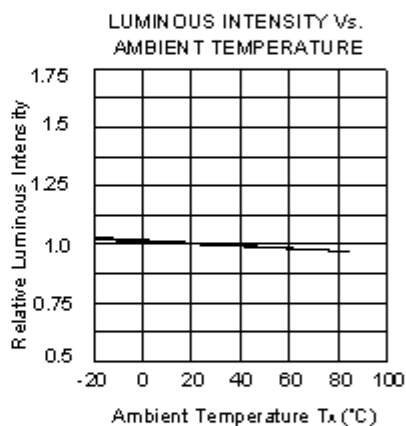
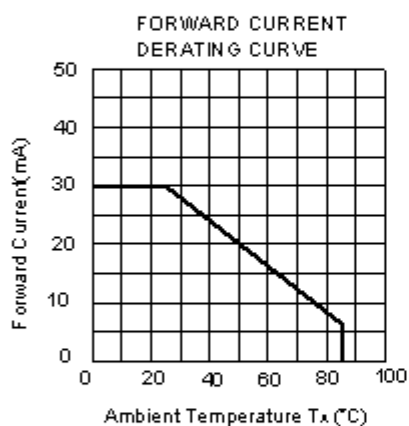
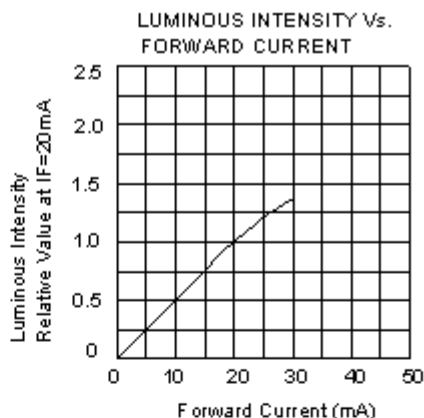
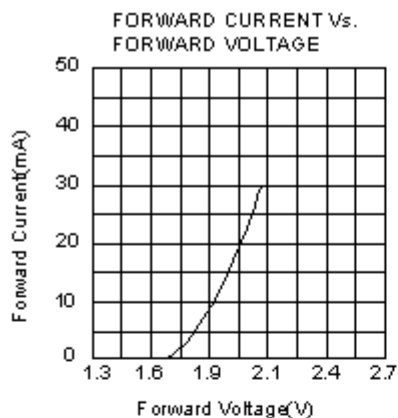

RELIABILITY TEST ITEMS AND CONDITIONS :

NO	Item	Test Conditions	Test Hours/Cycle	Sample Size	Judgment
1	Solder Heat	TEMP: 260±5°C	5 sec	76 pcs	ok
2	Temperature Cycle	H: +85°C 30 min ∫ 5 min L: -55°C 30 min	50 cycles	76 pcs	ok
3	Thermal shock	H: +100°C 30 min ∫ 5 min L: -10°C 30 min	50 cycles	76 pcs	ok
4	High Temperature Storage	TEMP: 100°C	1000 hrs	76 pcs	ok
5	Low Temperature Storage	TEMP: -55°C	1000 hrs	76 pcs	ok
6	DC Operating Life	TEMP: 25°C	1000 hrs	76 pcs	ok
7	High Temperature / High Humidity	85°C / 85%RH	1000 hrs	76 pcs	ok

Criteria for Judging the Damage:

Measuring Item	Symbol	Measuring	Judgement criteria for
Forward Voltage	VF	IF=20mA	OVER V* 120% OR 80%
Reverse Current	IR	VR=5V	OVER H*2
Luminous	IV	IF=20mA	L*0.5
Dominant	λ D	nm	OVER \pm 1.5nm (W)

Note:

1. V and H means the upper limit of specified characteristics. L and W means initial value.
2. Measurement shall be taken between 2 hours and after the test pieces have been returned to normal Ambient conditions after completion of each test.