

Printed-circuit board connector - MC 1,5/ 3-G-3,81 - 1803280

Please be informed that the data shown in this PDF Document is generated from our Online Catalog. Please find the complete data in the user's documentation. Our General Terms of Use for Downloads are valid (<http://phoenixcontact.com/download>)

PCB headers, nominal current: 8 A, number of positions: 3, pitch: 3.81 mm, color: green, contact surface: Tin, mounting: Wave soldering



The figure shows a 10-position version of the product

Your advantages

- Well-known mounting principle allows worldwide use
- Maximum flexibility when it comes to device design – one header for connectors with different connection technologies

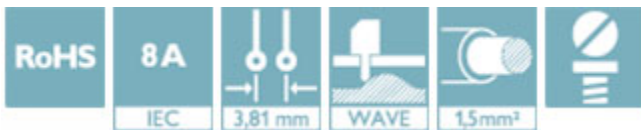

Key Commercial Data

Packing unit	1 pc
Minimum order quantity	250 pc
GTIN	
GTIN	4017918045593
Weight per Piece (excluding packing)	0.880 g
Custom tariff number	85366930
Country of origin	Germany

Technical data

Dimensions

Length [l]	9.2 mm
Width	12.82 mm
Pitch	3.81 mm
Dimension a	7.62 mm
Width [w]	12.82 mm

Printed-circuit board connector - MC 1,5/ 3-G-3,81 - 1803280

Technical data

Dimensions

Height [h]	10.65 mm
Height	7.25 mm
Length of the solder pin	3.4 mm
Pin dimensions	0.8 x 0.8 mm
Length	9.2 mm

General

Range of articles	MC 1,5/...-G
Insulating material group	IIIa
Rated surge voltage (III/3)	2.5 kV
Rated surge voltage (III/2)	2.5 kV
Rated surge voltage (II/2)	2.5 kV
Rated voltage (III/3)	160 V
Rated voltage (III/2)	160 V
Rated voltage (II/2)	250 V
Connection in acc. with standard	EN-VDE
Nominal current I _N	8 A
Maximum load current	8 A
Insulating material	PBT
Flammability rating according to UL 94	V0
Color	green
Number of positions	3

Standards and Regulations

Connection in acc. with standard	EN-VDE
	CSA
Flammability rating according to UL 94	V0

Environmental Product Compliance

China RoHS	Environmentally friendly use period: unlimited = EFUP-e
	No hazardous substances above threshold values

Drawings

Printed-circuit board connector - MC 1,5/ 3-G-3,81 - 1803280

Drilling diagram

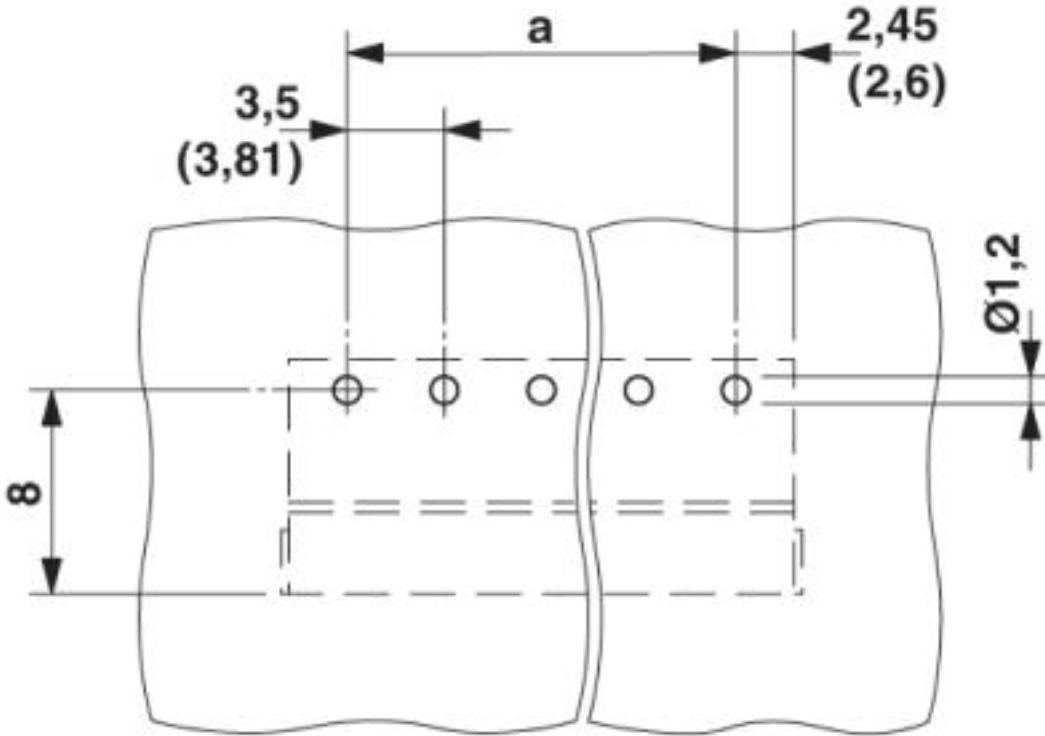

Printed-circuit board connector - MC 1,5/ 3-G-3,81 - 1803280

Diagram

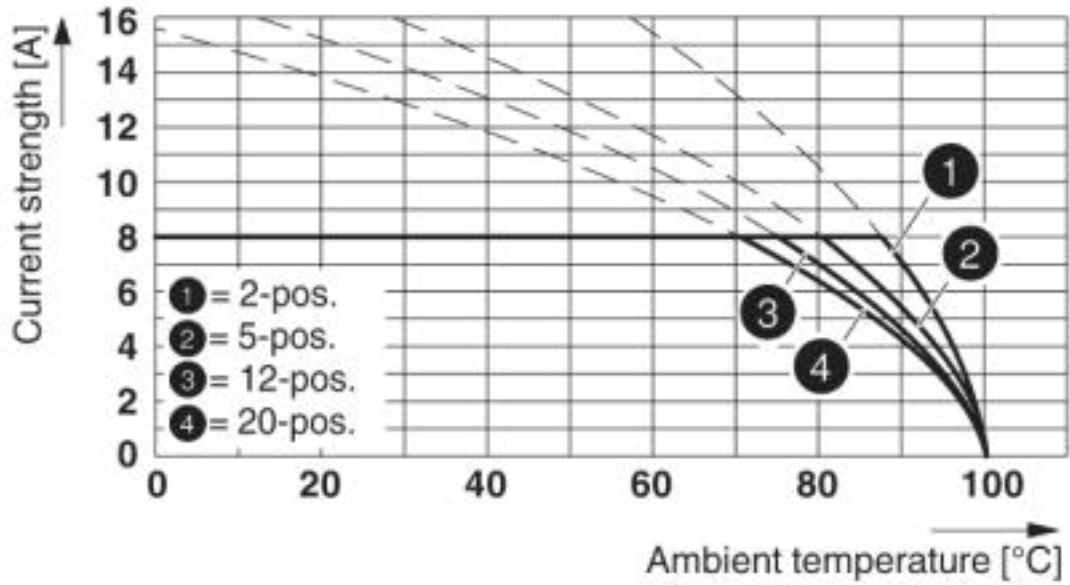

Type: MC 1,5/...-ST-3,81 with MC 1,5/...-G-3,81

Diagram

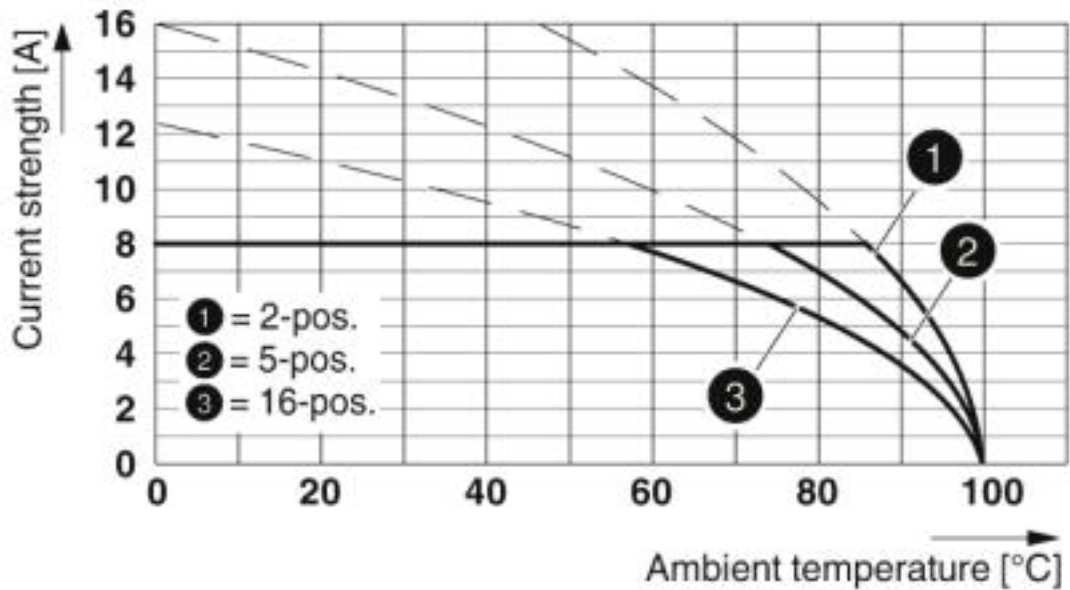

Type: IMC 1,5/...-G-3,81 with MC 1,5/...-G-3,81

Printed-circuit board connector - MC 1,5/ 3-G-3,81 - 1803280

Dimensional drawing

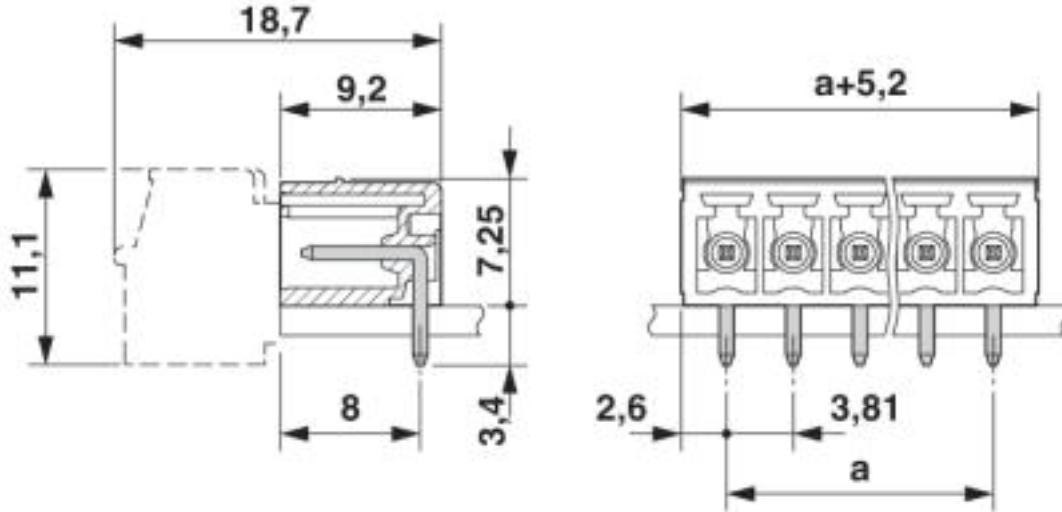

Classifications

eCl@ss

eCl@ss 4.0	27260700
eCl@ss 4.1	27260700
eCl@ss 5.0	27260700
eCl@ss 5.1	27260700
eCl@ss 6.0	27260700
eCl@ss 7.0	27440402
eCl@ss 8.0	27440402
eCl@ss 9.0	27440402

ETIM

ETIM 3.0	EC001121
ETIM 4.0	EC002637
ETIM 5.0	EC002637
ETIM 6.0	EC002637
ETIM 7.0	EC002637

UNSPSC

UNSPSC 6.01	30211810
UNSPSC 7.0901	39121409
UNSPSC 11	39121409
UNSPSC 12.01	39121409
UNSPSC 13.2	39121409

Printed-circuit board connector - MC 1,5/ 3-G-3,81 - 1803280

Approvals

Approvals

Approvals

CSA / IECCE CB Scheme / VDE Gutachten mit Fertigungsüberwachung / EAC / cULus Recognized

Ex Approvals

Approval details

CSA		http://www.csagroup.org/services-industries/product-listing/	13631
		B	D
Nominal voltage UN		300 V	300 V
Nominal current IN		8 A	8 A

IECEE CB Scheme		http://www.iecee.org/	DE1-60987-B1B2
Nominal voltage UN		160 V	
Nominal current IN		8 A	

VDE Gutachten mit Fertigungsüberwachung		http://www2.vde.com/de/Institut/Online-Service/VDE-gepruefteProdukte/Seiten/Online-Suche.aspx	40011723
Nominal voltage UN		160 V	
Nominal current IN		8 A	

EAC			B.01742
-----	---	--	---------

Printed-circuit board connector - MC 1,5/ 3-G-3,81 - 1803280

Approvals

cULus Recognized		http://database.ul.com/cgi-bin/XYV/template/LISEXT/1FRAME/index.htm	E60425-20110128
	B	D	
Nominal voltage UN	300 V	300 V	
Nominal current IN	8 A	8 A	

Accessories

Accessories

Coding element

Coding profile - CP-MSTB - 1734634

Coding profile, is inserted into the slot on the plug or inverted header, red insulating material



Fiber optic

Fiber optic - MC 1,5/10-LWL 1,5-3,81 - 1841174

MINI COMBICON fiber optics, 3.81 mm pitch, 10-pos., separable for other numbers of positions (minimum: 2-pos.), inserts into the back of the MC header, color: transparent, dimension a: 1.5 mm



Fiber optic - MC 1,5/10-LWL 2,3-3,81 - 1841190

MINI COMBICON fiber optics, 3.81 mm pitch, 10-pos., separable for other numbers of positions (minimum: 2-pos.), inserts into the back of the MC header, color: transparent, dimension a: 2.3 mm



Printed-circuit board connector - MC 1,5/ 3-G-3,81 - 1803280

Accessories

Fiber optic - MC 1,5/10-LWL 4-3,81 - 1841213

MINI COMBICON fiber optics, 3.81 mm pitch, 10-pos., separable for other numbers of positions (minimum: 2-pos.), inserts into the back of the MC header, color: transparent, dimension a: 4 mm



Labeled terminal marker

Marker card - SK 3,81/2,8:FORTL.ZAHLEN - 0804109



Marker card, Card, white, labeled, Horizontal: consecutive numbers 1 ... 10, 11 ... 20, etc. up to 91 ... (99)100, mounting type: adhesive, for terminal block width: 3.81 mm, lettering field size: 3.81 x 2.8 mm

Marker pen

Marker pen - B-STIFT - 1051993



Marker pen, for manual labeling of unprinted Zack strips, smear-proof and waterproof, line thickness 0.5 mm

Additional products

Printed-circuit board connector - FMC 1,5/ 3-ST-3,81 - 1745904



PCB connector, nominal current: 8 A, number of positions: 3, pitch: 3.81 mm, connection method: Push-in spring connection, color: green, contact surface: Tin

Printed-circuit board connector - MC 1,5/ 3-G-3,81 - 1803280

Accessories

Printed-circuit board connector - MC 1,5/ 3-ST-3,81 - 1803581



PCB connector, nominal current: 8 A, number of positions: 3, pitch: 3.81 mm, connection method: Screw connection with tension sleeve, color: green, contact surface: Tin

Printed-circuit board connector - MCVW 1,5/ 3-ST-3,81 - 1826982



PCB connector, nominal current: 8 A, number of positions: 3, pitch: 3.81 mm, connection method: Screw connection with tension sleeve, color: green, contact surface: Tin

Printed-circuit board connector - MCVR 1,5/ 3-ST-3,81 - 1827130



PCB connector, nominal current: 8 A, number of positions: 3, pitch: 3.81 mm, connection method: Screw connection with tension sleeve, color: green, contact surface: Tin

Printed-circuit board connector - FRONT-MC 1,5/ 3-ST-3,81 - 1850673



PCB connector, nominal current: 8 A, number of positions: 3, pitch: 3.81 mm, connection method: Front screw connection, color: green, contact surface: Tin

Printed-circuit board connector - FK-MCP 1,5/ 3-ST-3,81 - 1851054



PCB connector, nominal current: 8 A, number of positions: 3, pitch: 3.81 mm, connection method: Push-in spring connection, color: green, contact surface: Tin

Printed-circuit board connector - MC 1,5/ 3-G-3,81 - 1803280

Accessories

Printed-circuit board connector - MCC 1/ 3-STZ-3,81 - 1852189



PCB connector, nominal current: 8 A, number of positions: 3, pitch: 3.81 mm, connection method: Crimp connection, color: green, Corresponding female crimp contacts with current [A] and conductor cross section range [mm²] data: 5A/MCC-MT 0,2-0,35 (1859988); 8A/MCC-MT 0,5-1,0 (1859991)

Printed-circuit board connector - QC 0,5/ 3-ST-3,81 - 1897403

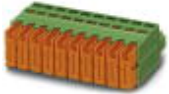

PCB connector, nominal current: 6 A, number of positions: 3, pitch: 3.81 mm, connection method: Displacement connection, color: green, contact surface: Tin