

# Surface Mount Aluminum Electrolytic Capacitors NACZ Series

## FEATURES

- CYLINDRICAL V-CHIP CONSTRUCTION FOR SURFACE MOUNTING
- VERY LOW IMPEDANCE & HIGH RIPPLE CURRENT AT 100KHz
- SUITABLE FOR DC-DC CONVERTER, DC-AC INVERTER, ETC.
- NEW EXPANDED CV RANGE, UP TO 6800 $\mu$ F
- NEW HIGH TEMPERATURE REFLOW "M1" VERSION
- DESIGNED FOR AUTOMATIC MOUNTING AND REFLOW SOLDERING
- **MEETS THE REQUIREMENTS OF AEC-Q200\***

\*Contact NIC for supporting test data

See **NAZT** for  
New Designs

**RoHS  
Compliant**

includes all homogeneous materials



\*See Part Number System for Details

## CHARACTERISTICS

Rated Voltage Rating	6.3 ~ 50Vdc
Rated Capacitance Range	4.7 ~ 6800 $\mu$ F
Operating Temp. Range	-55 ~ +105°C
Capacitance Tolerance	$\pm$ 20% (M)
Max. Leakage Current After 2 Minutes @ 20°C	0.01CV Or 3 $\mu$ A, whichever is greater

**LOW IMPEDANCE  
AT HIGH FREQUENCY**  
INDUSTRY STANDARD  
STYLE FOR SWITCHERS  
AND CONVERTERS

**LOW ESR COMPONENT  
LIQUID ELECTROLYTE**  
For Performance Data  
see [www.LowESR.com](http://www.LowESR.com)

Tan $\delta$ @ 120Hz/20°C	W.V. (Vdc)	6.3	10	16	25	35	50	
	S.V. (Vdc)	8.0	13	20	32	44	63	
	$\phi$ 4 ~ $\phi$ 6.3mm Dia.	0.24	0.20	0.16	0.14	0.12	0.10	
	$\phi$ 8 ~ $\phi$ 16mm Dia.	C $\leq$ 1000 $\mu$ F	0.28	0.24	0.20	0.16	0.14	0.14
		C = 1500 $\mu$ F	0.29	0.25	0.21	-	0.14	-
		C = 2200 $\mu$ F	0.30	0.26	-	0.18	-	-
C = 3300 $\mu$ F		0.32	-	0.24	-	-	-	
C = 4700 $\mu$ F		0.34	0.30	-	-	-	-	
Low Temperature Stability Impedance Ratio @ 120Hz	W.V. (Vdc)	6.3	10	16	25	35	50	
	Z-40°C/Z+20°C	3	2	2	2	2	2	
	Z-55°C/Z+20°C	5	4	4	3	3	3	
Load Life Test @ 105°C 4 ~ 6mm Dia., 10x8mm 1,000 hours 8 ~ 12.5mm Dia. 2,000 hours	Capacitance Change	Within $\pm$ 25% of initial measured value						
	Tan $\delta$	Less than $\pm$ 200% of the specified maximum value						
	Leakage Current	Less than the specified maximum value						

## STANDARD PRODUCT AND CASE SIZE TABLE D $\phi$ x L (mm)

Cap ( $\mu$ F)	Code	Working Voltage (Vdc)					
		6.3	10	16	25	35	50
4.7	4R7	-	-	-	-	4x6.3	4x6.3
10	100	-	-	-	4x6.3*	5x6.3*	6.3x6.3*
15	150	-	-	4x6.3	5x6.3	5x6.3*	-
22	220	-	4x6.3	5x6.3*	5x6.3	5x6.3*	6.3x6.3*
27	270	4x6.3*	-	-	-	-	-
33	330	-	5x6.3	-	6.3x6.3	6.3x6.3*	6.3x8*
47	470	5x6.3	-	6.3x6.3	6.3x6.3	6.3x6.3*	6.3x8*
56	560	5x6.3*	-	-	6.3x6.3	-	-
68	680	-	6.3x6.3	6.3x6.3*	6.3x6.3	6.3x8*	8x10.5*
100	101	6.3x6.3*	-	6.3x6.3*	6.3x8*	8x10.5	8x10.5*
120	121	-	6.3x6.3	-	-	-	-
150	151	6.3x6.3	6.3x6.3	6.3x8*	8x10.5*	8x10.5*	10x10.5*
						10x8	
220	221	6.3x6.3	6.3x8	6.3x8*	8x10.5*	8x10.5	10x10.5
					10x8		
330	331	6.3x8*	8x10.5	8x10.5*	8x10.5	10x10.5	12.5x14
				10x8			
390	391	-	-	-	-	-	12.5x14
470	471	8x10.5	8x10.5	8x10.5	10x10.5*	12.5x14	16x17
			10x8				
680	681	8x10.5	-	10x10.5	-	12.5x14	-
		10x8*					
820	821	-	10x10.5	-	-	-	-
1000	102	8x10.5*	10x10.5	-	12.5x14	-	16x17
1500	152	10x10.5*	-	12.5x14	-	16x17	-
2200	222	-	12.5x14	-	16x17	-	-
3300	332	12.5x14	-	16x17	-	-	-
4700	472	-	16x17	-	-	-	-
6800	682	16x17	-	-	-	-	-



# Surface Mount Aluminum Electrolytic Capacitors NACZ Series

## STANDARD VALUES, CASE SIZES AND SPECIFICATIONS

NIC Part Number*	Cap. (µF)	W.V. (Vdc)	Dissipation Factor (Tan δ)	Max. Ripple Current (mA) +105°C, 100KHz	Max. Impedance (Ω) +20°C, 100KHz	Load Life Hours @ +105°C
NACZ270M6.3V4X6.3TR_F	27	6.3	0.24	80	1.80	1,000
NACZ470M6.3V5X6.3TR_F	47		0.24	150	0.76	1,000
NACZ560M6.3V5X6.3TR_F	56		0.24	150	0.76	1,000
NACZ101M6.3V6.3X6.3TR_F	100		0.24	230	0.44	1,000
NACZ151M6.3V6.3X6.3TR_F	150		0.24	230	0.44	1,000
NACZ221M6.3V6.3X6.3TR_F	220		0.24	230	0.44	1,000
NACZ331M6.3V6.3X8TR_F	330		0.24	280	0.34	1,000
NACZ471M6.3V8X10.5TR_F	470		0.28	450	0.17	2,000
NACZ681M6.3V8X10.5TR_F	680		0.28	450	0.17	2,000
NACZ681M6.3V10X8TR_F						1,000
NACZ102M6.3V8X10.5TR_F	1000		0.28	450	0.17	2,000
NACZ152M6.3V10X10.5TR_F	1500		0.29	670	0.09	2,000
NACZ332M6.3V12.5X14TR_F	3300		0.32	900	0.066	2,000
NACZ682M6.3V16X17TR_F	6800		0.38	1250	0.052	2,000
NACZ220M10V4X6.3TR_F	22	10	0.20	80	1.80	1,000
NACZ330M10V5X6.3TR_F	33		0.20	150	0.76	1,000
NACZ680M10V6.3X6.3TR_F	68		0.20	230	0.44	1,000
NACZ121M10V6.3X6.3TR_F	120		0.20	230	0.44	1,000
NACZ151M10V6.3X6.3TR_F	150		0.20	230	0.44	1,000
NACZ221M10V6.3X8TR_F	220		0.20	280	0.34	1,000
NACZ331M10V8X10.5TR_F	330		0.24	450	0.17	2,000
NACZ471M10V8X10.5TR_F	470		0.24	450	0.17	2,000
NACZ471M10V10X8TR_F						1,000
NACZ821M10V10X10.5TR_F	820		0.24	670	0.09	2,000
NACZ102M10V10X10.5TR_F	1000		0.24	670	0.09	2,000
NACZ222M10V12.5X14TR_F	2200		0.26	900	0.066	2,000
NACZ472M10V16X17TR_F	4700		0.30	1250	0.052	2,000
NACZ150M16V4X6.3TR_F	15		16	0.16	80	1.80
NACZ220M16V5X6.3TR_F	22	0.16		150	0.76	1,000
NACZ470M16V6.3X6.3TR_F	47	0.16		230	0.44	1,000
NACZ680M16V6.3X6.3TR_F	68	0.16		230	0.44	1,000
NACZ101M16V6.3X6.3TR_F	100	0.16		230	0.44	1,000
NACZ151M16V6.3X8TR_F	150	0.16		280	0.34	1,000
NACZ221M16V6.3X8TR_F	220	0.16		280	0.34	1,000
NACZ331M16V8X10.5TR_F	330	0.20		450	0.17	2,000
NACZ331M16V10X8TR_F						1,000
NACZ471M16V8X10.5TR_F	470	0.20		450	0.17	2,000
NACZ681M16V10X10.5TR_F	680	0.20		670	0.09	2,000
NACZ152M16V12.5X14TR_F	1500	0.21		900	0.066	2,000
NACZ332M16V16X17TR_F	3300	0.24		1250	0.052	2,000
NACZ100M25V4X6.3TR_F	10	25		0.14	80	1.80
NACZ150M25V5X6.3TR_F	15		0.14	150	0.76	1,000
NACZ220M25V5X6.3TR_F	22		0.14	150	0.76	1,000
NACZ330M25V6.3X6.3TR_F	33		0.14	230	0.44	1,000
NACZ470M25V6.3X6.3TR_F	47		0.14	230	0.44	1,000
NACZ560M25V6.3X6.3TR_F	56		0.14	230	0.44	1,000
NACZ680M25V6.3X6.3TR_F	68		0.14	230	0.44	1,000
NACZ101M25V6.3X8TR_F	100		0.14	280	0.34	1,000
NACZ151M25V8X10.5TR_F	150		0.16	450	0.17	2,000
NACZ221M25V8X10.5TR_F	220		0.16	450	0.17	2,000
NACZ221M25V10X8TR_F						1,000
NACZ331M25V8X10.5TR_F	330		0.16	450	0.17	2,000
NACZ471M25V10X10.5TR_F	470		0.16	670	0.09	2,000
NACZ102M25V12.5X14TR_F	1000		0.16	900	0.066	2,000
NACZ222M25V16X17TR_F	2200	0.18	1250	0.052	2,000	
NACZ4R7M35V4X6.3TR_F	4.7	35	0.12	80	1.80	1,000
NACZ100M35V5X6.3TR_F	10		0.12	150	0.76	1,000
NACZ150M35V5X6.3TR_F	15		0.12	150	0.76	1,000
NACZ220M35V5X6.3TR_F	22		0.12	150	0.76	1,000
NACZ330M35V6.3X6.3TR_F	33		0.12	230	0.44	1,000
NACZ470M35V6.3X6.3TR_F	47		0.12	230	0.44	1,000

Part Number Suffix Where \_ : Preferred (15" reel) = 15, Legacy (13" reel) = 13 (check with NIC for availability)

\*For Automotive Equipment and high temperature reflow version see part number system



NIC COMPONENTS CORP.

www.niccomp.com

SPECIFICATIONS ARE SUBJECT TO CHANGE

# Surface Mount Aluminum Electrolytic Capacitors NACZ Series

## STANDARD VALUES, CASE SIZES AND SPECIFICATIONS

NIC Part Number*	Cap. (μF)	W.V. (Vdc)	Dissipation Factor (Tan δ)	Max. Ripple Current (mA) +105°C, 100KHz	Max. Impedance (Ω) +20°C, 100KHz	Load Life Hours @ +105°C
NACZ680M35V6.3X8TR_F	68	35	0.12	280	0.34	1,000
NACZ101M35V8X10.5TR_F	100		0.14	450	0.17	2,000
NACZ151M35V8X10.5TR_F	150		0.14	450	0.17	2,000
NACZ151M35V10X8TR_F						1,000
NACZ221M35V8X10.5TR_F	220		0.14	450	0.17	2,000
NACZ331M35V10X10.5TR_F	330		0.14	670	0.09	2,000
NACZ471M35V12.5X14TR_F	470		0.14	900	0.066	2,000
NACZ681M35V12.5X14TR_F	680		0.14	900	0.066	2,000
NACZ152M35V16X17TR_F	1500		0.14	1250	0.052	2,000
NACZ4R7M50V4X6.3TR_F	4.7	50	0.10	60	2.90	1,000
NACZ100M50V6.3X6.3TR_F	10		0.10	165	0.88	1,000
NACZ220M50V6.3X6.3TR_F	22		0.10	165	0.88	1,000
NACZ330M50V6.3X8TR_F	33		0.10	195	0.75	1,000
NACZ470M50V6.3X8TR_F	47		0.10	195	0.75	1,000
NACZ680M50V8X10.5TR_F	68		0.14	300	0.40	2,000
NACZ101M50V8X10.5TR_F	100		0.14	300	0.40	2,000
NACZ151M50V10X10.5TR_F	150		0.14	450	0.22	2,000
NACZ221M50V10X10.5TR_F	220		0.14	450	0.22	2,000
NACZ331M50V12.5X14TR_F	330		0.14	620	0.14	2,000
NACZ391M50V12.5X14TR_F	390		0.14	620	0.14	2,000
NACZ471M50V16X17TR_F	470		0.14	790	0.078	2,000
NACZ102M50V16X17TR_F	1000		0.14	790	0.078	2,000

Part Number Suffix Where \_\_: Preferred (15" reel) = 15, Legacy (13" reel) = 13 (check with NIC for availability)

\*For Automotive Equipment and high temperature reflow version see part number system

## RIPPLE CURRENT FREQUENCY CORRECTION FACTORS

Capacitance (μF)	Frequency			
	100Hz ≤ F < 1KHz	1KHz ≤ F < 10KHz	10KHz ≤ F < 100KHz	100KHz ≤ F
C ≤ 33	0.35	0.70	0.90	1.00
33 < C ≤ 150	0.40	0.85	0.92	1.00
150 < C	0.60	0.85	0.95	1.00

## DIMENSIONS (mm)

Case Size	φD±0.5	L max.	A±0.2	B±0.2	I±0.3	W	P±0.3
4x6.3	4.0	6.3	4.3	4.3	1.8	0.5~0.8	1.0
5x6.3	5.0	6.3	5.3	5.3	2.2	0.5~0.8	1.4
6.3x6.3	6.3	6.3	6.6	6.6	2.5	0.5~0.8	2.2
6.3X8	6.3	8.0	6.6	6.6	2.5	0.5~0.8	2.2
8X10.5	8.0	10.5	8.3	8.3	2.9	0.7~1.1	3.2
10X8	10.0	8.0	10.3	10.3	3.2	0.7~1.4	4.6
10X10.5	10.0	10.5	10.3	10.3	3.2	0.7~1.4	4.6
12.5x14	12.5	14.0	12.8	12.8	4.5	1.0~1.4	4.6
16x17	16.0	17.0	16.3	16.3	5.0	1.7~2.1	7.0

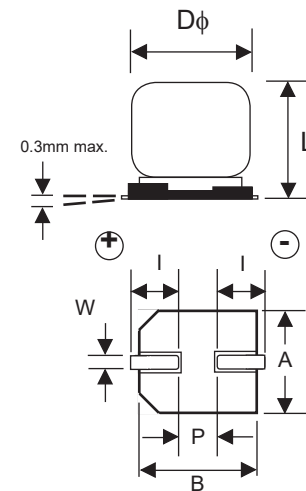

## PART NUMBER SYSTEM

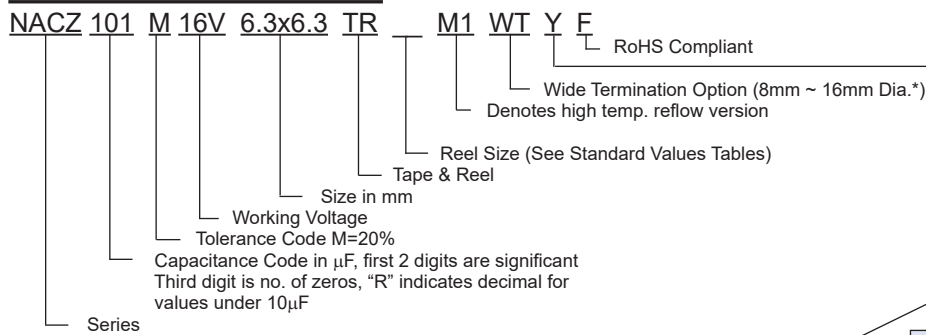

Optional: Suitable for automotive equipment, sourced to special production and inspection at IATF-16949 certified production site.

Case Diameter	Termination Material
4 ~ 12.5mm φ	97% Sn, 3% Bi
16mm	100% Sn

# Surface Mount Aluminum Electrolytic Capacitors NACZ Series

## PEAK REFLOW SOLDERING TEMPERATURES AND DURATIONS (STANDARD VERSION)

Case Size	Preheat: 150°C ~ 180°C	Max. Soldering Temperature	Max. Exposure Time at Max. Soldering Temperature	Max. Exposure Time Above +217°C	Max. Exposure Time Above +200°C	Multiple Reflow Exposure
4x6.3	120 seconds max.	+250°C	5 seconds	60 seconds	70 seconds	2 times max.
5x6.3	120 seconds max.	+250°C	5 seconds	60 seconds	70 seconds	2 times max.
6.3x6.3	120 seconds max.	+250°C	5 seconds	60 seconds	70 seconds	2 times max.
6.3x8	120 seconds max.	+250°C	5 seconds	60 seconds	70 seconds	2 times max.
8x10.5	120 seconds max.	+245°C	5 seconds	50 seconds	60 seconds	2 times max.
10x8	120 seconds max.	+240°C	5 seconds	40 seconds	50 seconds	2 times max.
10x10.5	120 seconds max.	+240°C	5 seconds	40 seconds	50 seconds	2 times max.
12.5x14	120 seconds max.	+240°C	5 seconds	40 seconds	50 seconds	2 times max.
16x17	120 seconds max.	+230°C	5 seconds	30 seconds	50 seconds	2 times max.

## PEAK REFLOW SOLDERING TEMPERATURES AND DURATIONS (M1 VERSION)

Case Size	Preheat: 150°C ~ 180°C	Max. Soldering Temperature	Max. Exposure Time at Max. Soldering Temperature	Max. Exposure Time Above +200°C	Max. Exposure Time Above +230°C	Multiple Reflow Exposure
4x6.3	120 seconds max.	+255°C	5 seconds	60 seconds	30 seconds	2 times max.
5x6.3	120 seconds max.	+255°C	5 seconds	60 seconds	30 seconds	2 times max.
6.3x6.3	120 seconds max.	+255°C	5 seconds	60 seconds	30 seconds	2 times max.
6.3x8	120 seconds max.	+255°C	5 seconds	60 seconds	30 seconds	2 times max.
8x10.5	120 seconds max.	+250°C	5 seconds	60 seconds	30 seconds	2 times max.
10x8	120 seconds max.	+250°C	5 seconds	60 seconds	30 seconds	2 times max.
10x10.5	120 seconds max.	+250°C	5 seconds	60 seconds	20 seconds	2 times max.

### RECOMMENDED REFLOW SOLDERING PROFILE

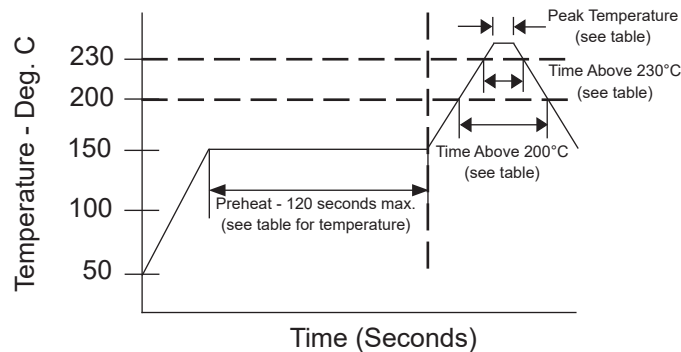

### RECOMMENDED LAND PATTERN DIMENSIONS (mm)

Case Size	a	b	c
4 φ	1.0	2.6	1.8
5 φ	1.4	3.0	1.8
6.3 φ	1.8	3.6	1.8
8 φ	2.8	4.1	2.1
10 φ	4.3	4.4	2.5
12.5 φ	4.3	5.8	2.5
16 φ	6.6	6.5	5.0

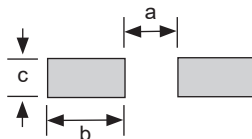

Review & Compare Reflow Soldering Heat Limits  
V-chip SMT Aluminum Electrolytic Capacitors  
[www.niccomp.com/RSL](http://www.niccomp.com/RSL)

# Surface Mount Aluminum Electrolytic Capacitors NACZ Series

## WT (WIDE TERMINATIONS) COMPONENT DIM. (mm)

Case Size	D $\phi$ $\pm$ 0.5	L max.	A, B $\pm$ 0.2	C max.	P	W	R	T
8x10.5	8.0	11.0	8.3	10.0	(3.2)	0.7 ~ 1.1	(0.7)	(1.3)
10x10.5	10.0	11.0	10.3	12.0	(4.6)	0.7 ~ 1.4	(0.7)	(1.3)
12.5x14	12.5	14.5	13.5	15.0	(4.6)	1.0 ~ 1.4	(2.2)	(2.4)
16x17	16.0	17.5	17.0	19.0	(7.0)	1.7 ~ 2.1	(3.0)	(2.0)

(Reference Dimension)

## WT (WIDE TERMINATIONS) LAND PATTERN DIM. (mm)

Case Size	a	b	c
8x10.5	2.5	4.5	4.7
10x10.5	3.8	4.8	4.7
12.5x14	3.8	6.1	6.9
16x17	5.0	8.0	9.5

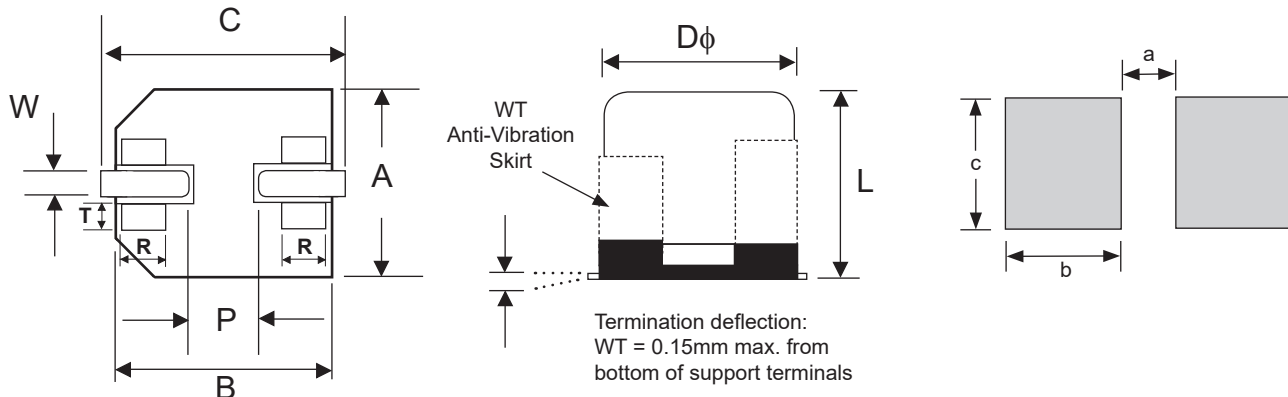

WT (Wide Terminations) Anti-Vibration Test	
Test Method	Direction: X, Y, Z axis Frequency & Duration: 5 to 2000Hz reciprocation for 20 minutes, 2 hours each direction Peak to Peak Amplitude: 5mm Peak Acceleration: 30G Sweep Type: Log
$\Delta$ Capacitance	Within $\pm$ 10% of initial value
Tangent of Loss	$\leq$ Specified value
Leakage Current	$\leq$ Specified value

### PRECAUTIONS

Please review the notes on correct use, safety and precautions found at <https://www.niccomp.com/resource/files/aluminum/AlumApplInfoCautions.pdf>  
If in doubt or uncertainty, please review your specific application - process details with NIC's technical support personnel: [tpmg@niccomp.com](mailto:tpmg@niccomp.com)

## CARRIER TAPE

Case Size	A ±0.5	B ±0.2	C ±0.3	D ±0.1	P ±0.1	T ±0.2
4 x 6.3	4.7	4.7	12.0	5.5	8.0	6.4
5 x 6.3	5.7	5.7	12.0	5.5	12.0	6.4
6.3 x 6.3	7.0	7.0	16.0	7.5	12.0	6.5
6.3 x 8	7.0	7.0	16.0	7.5	12.0	8.2
8 X 10.5	8.7	8.7	24.0	11.5	16.0	11.1
10 x 8	10.7	10.7	24.0	11.5	16.0	8.3
10 x 10.5	10.7	10.7	24.0	11.5	16.0	11.2
12.5 x 14	13.2	13.2	32.0	14.2	24.0	14.3
16 x 17	17.5	17.5	44.0	20.2	28.0	17.3

## TAPING SPECIFICATIONS (mm)

1. Both Leader and Trailer tape: Minimum 40mm (1.57") empty carrier tape pockets.
2. Leader tape: Approximately 20cm of cover tape at leader.
3. Connection: Maximum 3 connections (slices) per reel.

## CARRIER

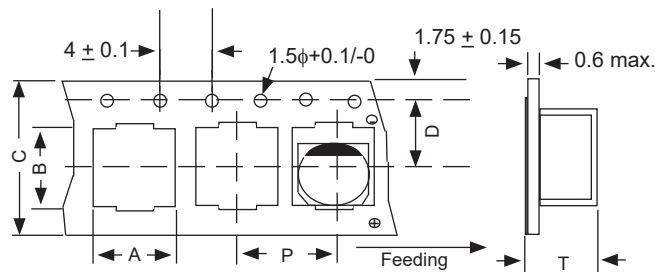

# Surface Mount Aluminum Electrolytic Capacitors NACZ Series

## Preferred V-Chip 380mm Reels (TR15 suffix)

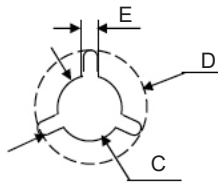
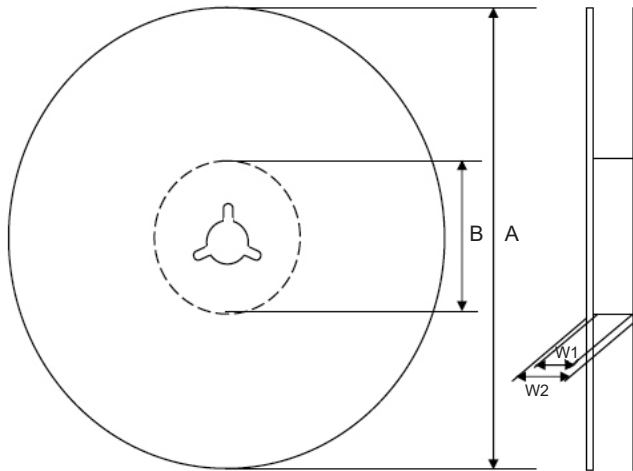

### Dimensions (mm)

Case Diameter	Tape Width	W1	W2
4x6.3, 5x6.3	12.0	12.4 ~ 14.4	15.5 ~ 20.0
6.3x6.3, 6.3x8	16.0	16.4 ~ 18.4	19.5 ~ 24.0
8x10.5, 10x8, 10x10.5	24.0	24.4 ~ 26.4	27.5 ~ 32.0
12.5x14	32.0	32.4 ~ 35.0	36.2 ~ 38.4
16x17	44.0	44.4 ~ 47.0	48.2 ~ 50.4

Case Size	Tape Width	A	B	C	D	E
4x6.3, 5x6.3	12.0	$\phi 330$ $\pm 2.0$	$\phi 50 \sim 105$	$\phi 13$ $\pm 0.5$	$\phi 21$ $\pm 1.0$	2.0 $\pm 0.5$
6.3x6.3, 6.3x8	16.0					
8x10.5, 10x8, 10x10.5	24.0					
12.5x14	32.0					
16x17	44.0					

Color
Black or Blue

## Optional V-Chip 330mm Reels (TR13 suffix)

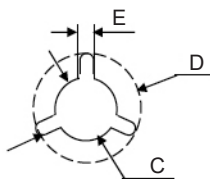
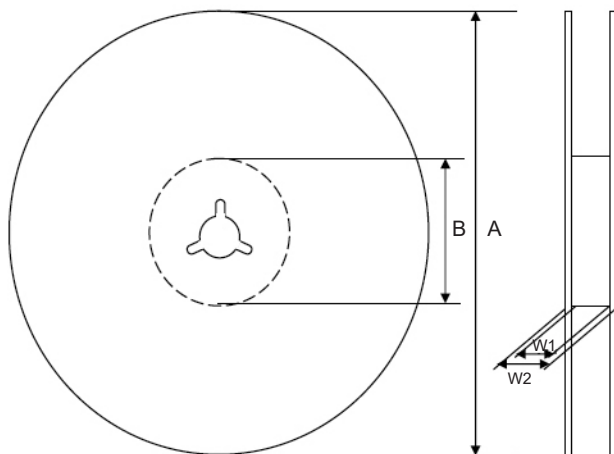

### Dimensions (mm)

Case Diameter	Tape Width	W1	W2
4x6.3, 5x6.3	12.0	12.4 ~ 14.4	15.5 ~ 20.0
6.3x6.3, 6.3x8	16.0	16.4 ~ 18.4	19.5 ~ 24.0
8x10.5, 10x8, 10x10.5	24.0	24.4 ~ 26.4	27.5 ~ 32.0

Case Size	Tape Width	A	B	C	D	E
4x6.3, 5x6.3	12.0	$\phi 330$ $\pm 2.0$	$\phi 50 \sim 105$	$\phi 13$ $\pm 0.5$	$\phi 21$ $\pm 1.0$	2.0 $\pm 0.5$
6.3x6.3, 6.3x8	16.0					
8x10.5, 10x8, 10x10.5	24.0					

Color
Black or Blue

Case Size	Quantity Per Reel	
	13" Reel	15" Reel
4 x 6.3	1,200 pcs	2,000 pcs
5 x 6.3	800 pcs	1,000 pcs
6.3 x 6.3	800 pcs	1,000 pcs
6.3 x 8	500 pcs	900 pcs
8 X 10.5	300 pcs	500 pcs
10 x 8	400 pcs	500 pcs
10 x 10.5	300 pcs	500 pcs
12.5 x 14	-	250 pcs
16 x 17	-	200 pcs

