

# Supplementary Circuit Protectors Type GSB63

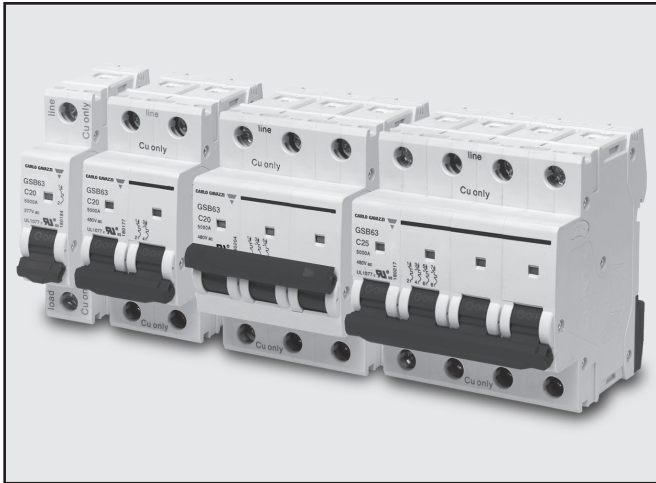

- Protection of circuits against short circuit and overload currents
- UL1077 supplementary protection
- 1, 2, 3 and 4 pole arrangements
- 13 amperage sizes up to 63Amps
- Icn of 5kA
- Bimetallic element for small overloads
- Magnetic element for short circuit protection
- B, C, D trip characteristics
- Full line of bus bars and connectors
- Auxiliary contact, alarm switch and shunt release accessories

## Product Description

Competitive line of supplementary circuit protectors are available in 1, 2, 3 and 4 pole configurations, with amperage rating up to 63A and voltage up to 480Y/277VAC. Protection is already provided

## Ordering Key

**GSB63 1P C 20**

Supplementary Protector \_\_\_\_\_  
 Number of poles \_\_\_\_\_  
 Tripping Characteristics \_\_\_\_\_  
 Overload range \_\_\_\_\_

## Selection Guide *(Refer to page 2 for list of valid part numbers)*

SCP	Numbers of poles	Tripping Characteristics	Overload Range (amps)
GSB63 Family	1P	C – C curve	1, 2, 3, 4, 6, 10,
	2P	(standard)	16, 20, 25, 32, 40,
	3P	B – B curve	50, 63
	4P	D – D curve	

## Selection Guide

### C Curve

In	1-pole	2-pole	3-pole	4-pole
1	<b>GSB63 1P C1</b>	<b>GSB63 2P C1</b>	<b>GSB63 3P C1</b>	<b>GSB63 4P C1</b>
2	<b>GSB63 1P C2</b>	<b>GSB63 2P C2</b>	<b>GSB63 3P C2</b>	<b>GSB63 4P C2</b>
3	<b>GSB63 1P C3</b>	<b>GSB63 2P C3</b>	<b>GSB63 3P C3</b>	<b>GSB63 4P C3</b>
4	<b>GSB63 1P C4</b>	<b>GSB63 2P C4</b>	<b>GSB63 3P C4</b>	<b>GSB63 4P C4</b>
6	<b>GSB63 1P C6</b>	<b>GSB63 2P C6</b>	<b>GSB63 3P C6</b>	<b>GSB63 4P C6</b>
10	<b>GSB63 1P C10</b>	<b>GSB63 2P C10</b>	<b>GSB63 3P C10</b>	<b>GSB63 4P C10</b>
16	<b>GSB63 1P C16</b>	<b>GSB63 2P C16</b>	<b>GSB63 3P C16</b>	<b>GSB63 4P C16</b>
20	<b>GSB63 1P C20</b>	<b>GSB63 2P C20</b>	<b>GSB63 3P C20</b>	<b>GSB63 4P C20</b>
25	<b>GSB63 1P C25</b>	<b>GSB63 2P C25</b>	<b>GSB63 3P C25</b>	<b>GSB63 4P C25</b>
32	<b>GSB63 1P C32</b>	<b>GSB63 2P C32</b>	<b>GSB63 3P C32</b>	<b>GSB63 4P C32</b>
40	<b>GSB63 1P C40</b>	<b>GSB63 2P C40</b>	<b>GSB63 3P C40</b>	<b>GSB63 4P C40</b>
50	<b>GSB63 1P C50</b>	<b>GSB63 2P C50</b>	<b>GSB63 3P C50</b>	<b>GSB63 4P C50</b>
63	<b>GSB63 1P C63</b>	<b>GSB63 2P C63</b>	<b>GSB63 3P C63</b>	<b>GSB63 4P C63</b>

### B Curve

In	1-pole	2-pole	3-pole	4-pole
1	<b>GSB631PB1</b>	<b>GSB632PB1</b>	<b>GSB633PB1</b>	<b>GSB634PB1</b>
2	<b>GSB631PB2</b>	<b>GSB632PB2</b>	<b>GSB633PB2</b>	<b>GSB634PB2</b>
3	<b>GSB631PB3</b>	<b>GSB632PB3</b>	<b>GSB633PB3</b>	<b>GSB634PB3</b>
4	<b>GSB631PB4</b>	<b>GSB632PB4</b>	<b>GSB633PB4</b>	<b>GSB634PB4</b>
6	<b>GSB631PB6</b>	<b>GSB632PB6</b>	<b>GSB633PB6</b>	<b>GSB634PB6</b>
10	<b>GSB631PB10</b>	<b>GSB632PB10</b>	<b>GSB633PB10</b>	<b>GSB634PB10</b>
16	<b>GSB631PB16</b>	<b>GSB632PB16</b>	<b>GSB633PB16</b>	<b>GSB634PB16</b>
20	<b>GSB631PB20</b>	<b>GSB632PB20</b>	<b>GSB633PB20</b>	<b>GSB634PB20</b>
25	<b>GSB631PB25</b>	<b>GSB632PB25</b>	<b>GSB633PB25</b>	<b>GSB634PB25</b>
32	<b>GSB631PB32</b>	<b>GSB632PB32</b>	<b>GSB633PB32</b>	<b>GSB634PB32</b>
40	<b>GSB631PB40</b>	<b>GSB632PB40</b>	<b>GSB633PB40</b>	<b>GSB634PB40</b>
50	<b>GSB631PB50</b>	<b>GSB632PB50</b>	<b>GSB633PB50</b>	<b>GSB634PB50</b>
63	<b>GSB631PB63</b>	<b>GSB632PB63</b>	<b>GSB633PB63</b>	<b>GSB634PB63</b>

### D Curve

In	1-pole	2-pole	3-pole	4-pole
1	<b>GSB631PD1</b>	<b>GSB632PD1</b>	<b>GSB633PD1</b>	<b>GSB634PD1</b>
2	<b>GSB631PD2</b>	<b>GSB632PD2</b>	<b>GSB633PD2</b>	<b>GSB634PD2</b>
3	<b>GSB631PD3</b>	<b>GSB632PD3</b>	<b>GSB633PD3</b>	<b>GSB634PD3</b>
4	<b>GSB631PD4</b>	<b>GSB632PD4</b>	<b>GSB633PD4</b>	<b>GSB634PD4</b>
6	<b>GSB631PD6</b>	<b>GSB632PD6</b>	<b>GSB633PD6</b>	<b>GSB634PD6</b>
10	<b>GSB631PD10</b>	<b>GSB632PD10</b>	<b>GSB633PD10</b>	<b>GSB634PD10</b>
16	<b>GSB631PD16</b>	<b>GSB632PD16</b>	<b>GSB633PD16</b>	<b>GSB634PD16</b>
20	<b>GSB631PD20</b>	<b>GSB632PD20</b>	<b>GSB633PD20</b>	<b>GSB634PD20</b>
25	<b>GSB631PD25</b>	<b>GSB632PD25</b>	<b>GSB633PD25</b>	<b>GSB634PD25</b>
32	<b>GSB631PD32</b>	<b>GSB632PD32</b>	<b>GSB633PD32</b>	<b>GSB634PD32</b>
40	<b>GSB631PD40</b>	<b>GSB632PD40</b>	<b>GSB633PD40</b>	<b>GSB634PD40</b>
50	<b>GSB631PD50</b>	<b>GSB632PD50</b>	<b>GSB633PD50</b>	<b>GSB634PD50</b>
63	<b>GSB631PD63</b>	<b>GSB632PD63</b>	<b>GSB633PD63</b>	<b>GSB634PD63</b>

Part numbers in bold font indicate stock item

Specifications are subject to change without notice — September-2020

## Electrical Specifications

Rated Current	1, 2, 3, 4, 6, 10, 16, 20, 25, 32, 40, 50, 63 A	
Poles	1, 2, 3 or 4 pole	
Rated Voltage	single phase 277 VAC	
	three phase 480Y/277VAC	
Insulation Voltage	500 VAC	
Rated Frequency	50/60 Hz	
Rated Breaking capacity	5,000 A	
Rated Impulse Withstand Voltage (1.2/50)	4,000 V	
Dielectric Test Voltage for 1 minute	2,000 V	
Pollution Degree	2	
Power loss per pole	1, 2, 3, 4, 5, 6, 10 A	2 W
	13, 16, 20, 25, 32 A	3.5 W
	40, 50, 63 A	5 W
Thermo—magnetic release characteristics	B, C (standard), D	
Electrical life	4,000 cycles	

## Mechanical Specifications

Mechanical life	20,000 cycles
Contact Position Indicator	Yes
Protection Degree	IP20
Reference Temperature	30°C
Operation Temperature Range	-35°C ~ +70°C (see table on page 3 for derating)
Terminal Connection Type	Copper/U-type busbar/Pin-type busbar
Wire Size Range	18-4 AWG
Busbar size range	18-8 AWG
Maximum tightening torque	22 In-lbs. (N*m 2)
Mounting	Vertical on DIN rail EN 60715 (35mm)
Connection	Line-in on top, line-out on bottom

## Temperature Derating

The maximum permissible current in a supplementary protector depends on the ambient temperature and spacing between devices (see next paragraph). Ambient temperature is the temperature inside the enclosure or switch-board in which circuit breaker is installed. The reference temperature for nominal current rating is 30°C.

Ambient Temp >	-35°C	-30°C	-20°C	-10°C	0°C	10°C	20°C	30°C	40°C	50°C	60°C	70°C
<b>Rated Current</b>												
1A	1.30	1.26	1.23	1.19	1.15	1.11	1.05	1.00	0.96	0.93	0.88	0.83
2A	2.60	2.52	2.46	2.38	2.28	2.20	2.08	2.00	1.92	1.86	1.76	1.66
3A	3.90	3.78	3.69	3.57	3.42	3.30	3.12	3.00	2.88	2.79	2.64	2.49
4A	5.20	5.04	4.92	4.76	4.56	4.40	4.16	4.00	3.84	3.76	3.52	3.32
6A	7.80	7.56	7.38	7.14	6.84	6.60	6.24	6.00	5.76	5.64	5.28	4.98
10A	13.20	12.76	12.50	12.00	11.50	11.10	10.60	10.00	9.60	9.30	8.90	8.40
16A	21.12	20.48	20.00	19.20	18.40	17.76	16.96	16.00	15.36	14.88	14.24	13.44
20A	26.40	25.60	25.00	24.00	23.00	22.20	21.20	20.00	19.20	18.60	17.80	16.80
25A	33.00	32.00	31.25	30.00	28.75	27.75	26.50	25.00	24.00	23.25	22.25	21.00
32A	42.56	41.28	40.00	38.72	37.12	35.52	33.92	32.00	30.72	29.76	28.16	26.88
40A	53.20	51.20	50.00	48.00	46.40	44.80	42.40	40.00	38.40	37.20	35.60	33.60
50A	67.00	65.50	63.00	60.50	58.00	56.00	53.00	50.00	48.00	46.50	44.00	41.50
63A	83.79	81.90	80.01	76.86	73.71	70.56	66.78	63.00	60.48	58.90	55.44	52.29

## Curve Profiles

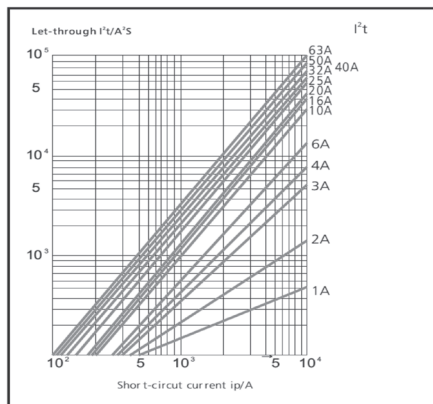
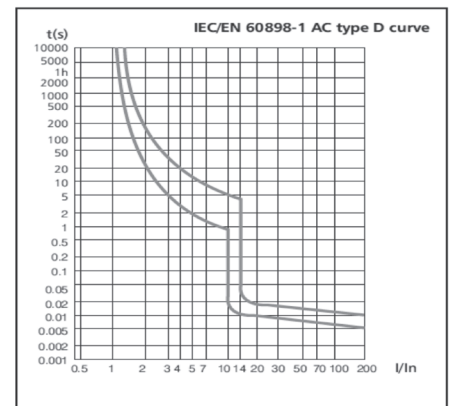
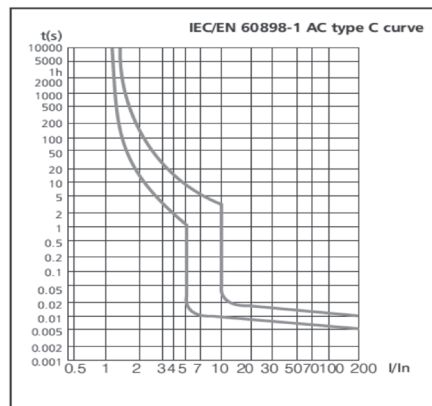
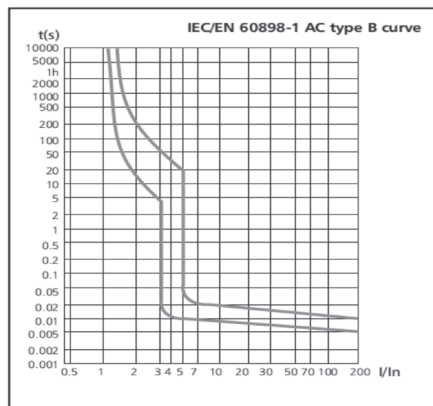

## Accessories

### Auxiliary Contact

#### General

#### Ordering key:

**GSBXF9**

Indication of the position of the device's contacts. To be mounted on the left side of the UL1077 supplementary protector, thanks to the special pin.

### Technical data

Standard	IEC/EN 60947-5-1		
Rated values	Voltage		Current
	AC415 50/60HZ		3A
	AC240 50/60HZ		6A
	DC130		1A
	DC48		2A
	DC24		6A
Electrical features	Configurations		1 N/O + 1 N/C
	Rated impulse withstand voltage (1.2/50)Uimp	V	4000
	Dielectric Test voltage at ind. Freq. for 1min	kV	2
	Insulation voltage Ui	V	500
	Pollution degree		2
Mechanical features	Electrical life		6,050
	Mechanical life		10,000
	Protection degree		IP20
	Ambient temperature (with daily average ≤35°C)	°C	-5...+40
	Storage temperature	°C	-25...+70
Installation	Terminal connection type T		Cable
	Terminal size top/bottom for cable	mm <sup>2</sup>	2.5
		AWG	18 ~ 14
	Tightening torque	N·m	0.8
ln-lbs.		7	
Approvals	CE only		

## Alarm Switch

### General

### Ordering key:

**GSBXF9J**

Indication of the position of the device's contacts only after the automatic release of the UL1077 supplementary protector, due to an overload or a short-circuit. To be mounted on the left side of the UL1077 device thanks to the special pin.

### Technical data

Standard	IEC/EN 60947-5-1		
Rated value	Voltage		Current
	AC415 50/60HZ		3A
	AC240 50/60HZ		6A
	DC130		1A
	DC48		2A
	DC24		6A
Electrical features	Configurations		1 N/O + 1 N/C
	Rated impulse withstand voltage (1.2/50)Uimp	V	4000
	Dielectric test voltage at ind. Freq. for 1min	kV	2
	Insulation voltage Ui	V	500
	Pollution degree		2
Mechanical features	Electrical life		6,050
	Mechanical life		10,000
	Protection degree		IP20
	Ambient temperature (with daily average ≤ 35°C)	°C	-5...+40
	Storage temperature	°C	-25...+70
Installation	Terminal connection type		Cable
	Terminal size top/bottom for cable	mm <sup>2</sup>	2.5
		AWG	18 ~ 14
	Tightening torque	N·m	0.8
ln-lbs.		7	
Approvals	CE only		

## Shunt release

### General

### Ordering key:

**GSBS9**

Remote opening of the device when a voltage is applied.

To be mounted on the left side of the UL1077 supplementary protector, thanks to the special pin.

### Technical data

Standard	IEC/EN 60947-5-1		
Rated value	Voltage		24VDC
	Configurations		1 N/O + 1 N/C
Electrical features	Rated impulse withstand voltage (1.2/50)Uimp	V	4000
	Dielectric TEST voltage at ind. Freq. for 1min	kV	2
	Insulation voltage Ui	V	500
	Pollution degree		2
Mechanical features	Electrical life		4,000
	Mechanical life		4,000
	Protection degree		IP20
	Ambient temperature (with daily average $\leq 35^{\circ}\text{C}$ )	$^{\circ}\text{C}$	-5...+70
	Storage temperature	$^{\circ}\text{C}$	-25...+70
Installation	Terminal connection type		Cable
	Terminal size top/bottom for cable	mm <sup>2</sup>	2.5
		AWG	18 ~ 14
	Tightening torque	N·m	0.8
In-lbs.		7	
Approvals	CE only		

# GSB63 — Busbars and Connectors

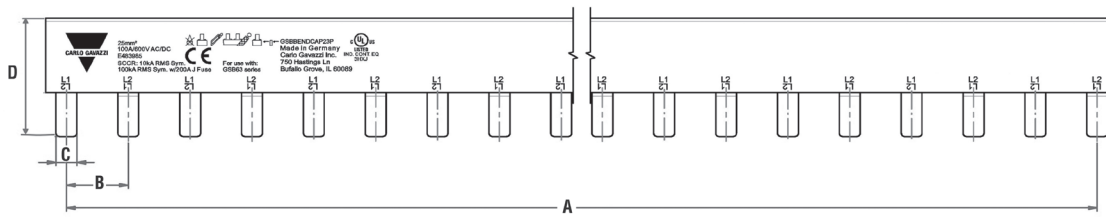

Accessory	Poles	Pins	Part Number	Description	Combined Amperage Rating	Rated voltage	Dimensions [mm / in]							
							A	B	C	D				
Busbar	1	6	GSBB1P06H	6 pins busbar 1 pole GSB	100A	600 VAC / 1000 VDC	89 / 3.5	17.8 / 0.70	5.5 / 0.22	16.7 / 0.66				
		12	GSBB1P12H	12 pins busbar 1 pole GSB	100A		196 / 7.72	17.8 / 0.70	5.5 / 0.22	16.7 / 0.66				
		18	GSBB1P18H	18 pins busbar 1 pole GSB	100A		303 / 11.92	17.8 / 0.70	5.5 / 0.22	16.7 / 0.66				
		57	<b>GSBB1P57H</b>	cuttable 57 pins busbar 1 pole GSB	100A		997 / 39.25	17.8 / 0.70	5.5 / 0.22	15.6 / 0.61				
		37	GSBB1P37HS	cuttable 37 pins busbar 1 pole GSB+AUX	100A		972 / 38.27	17.8 / 0.70	5.5 / 0.22	15.6 / 0.61				
	2	6	GSBB2P06H	6 pins busbar 2 pole GSB	100A	600 VAC / 600 VDC	89 / 3.5	17.8 / 0.70	5.5 / 0.22	36.5 / 1.44				
		12	GSBB2P12H	12 pins busbar 2 pole GSB	100A		196 / 7.72	17.8 / 0.70	5.5 / 0.22	36.5 / 1.44				
		18	GSBB2P18H	18 pins busbar 2 pole GSB	100A		303 / 11.93	17.8 / 0.70	5.5 / 0.22	36.5 / 1.44				
		56	<b>GSBB2P56H</b>	cuttable 57 pins busbar 2 pole GSB	100A		979 / 38.54	17.8 / 0.70	5.5 / 0.22	36.5 / 1.44				
		46	GSBB2P46HS	cuttable 37 pins busbar 2 pole GSB+AUX	100A		968 / 38.11	17.8 / 0.70	5.5 / 0.22	36.5 / 1.44				
	3	6	GSBB3P06H	6 pins busbar 3 pole GSB	100A	600 VAC / 600 VDC	89 / 3.5	17.8 / 0.70	5.5 / 0.22	36.5 / 1.44				
		12	GSBB3P12H	12 pins busbar 3 pole GSB	100A		196 / 7.72	17.8 / 0.70	5.5 / 0.22	36.5 / 1.44				
		18	GSBB3P18H	18 pins busbar 3 pole GSB	100A		303 / 11.93	17.8 / 0.70	5.5 / 0.22	36.5 / 1.44				
		57	<b>GSBB3P57H</b>	cuttable 57 pins busbar 3 pole GSB	100A		997 / 39.25	17.8 / 0.70	5.5 / 0.22	36.5 / 1.44				
		48	GSBB3P48HS	cuttable 37 pins busbar 3 pole GSB+AUX	100A		935 / 36.81	17.8 / 0.70	5.5 / 0.22	36.5 / 1.44				
Feeder	1		<b>GSBBFEED1P</b>	Feeder terminal 1 pole GSB	115A	600 VAC / 600 VDC	Part number in <b>bold font</b> indicate stock items							
	2, 3		<b>GSBBFEED23P</b>	Feeder terminal 2 & 3 pole GSB	115A									
Center feeder	all		<b>GSBBCENFEED</b>	Center feeder terminal	115A									
End cap	1		<b>GSBBENDCAP1P</b>	End cover 1 pole GSB	n / a	n / a					Approvals - CE, cULus (UL508)			
	2, 3		<b>GSBBENDCAP23P</b>	End cover 2 & 3 pole GSB										
Pin cap	all		<b>GSBBPINCAP</b>	Protective pin cap										



**Dimensions**

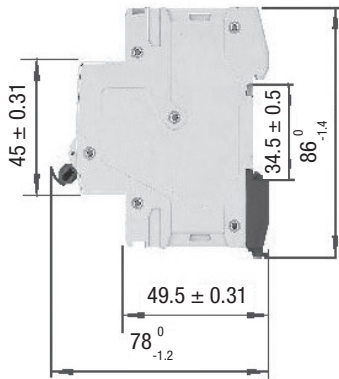

1P



1P+N, 2P

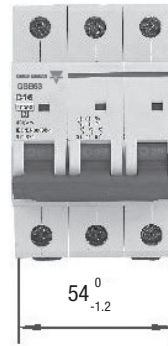

3P

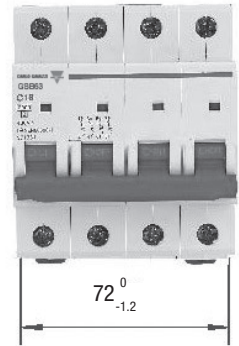

3P+N, 4P

**Agency Approvals**

GSB Supplementary Protectors



GSB Supplementary Protectors



GSBB Busbars and Busbar Accessories



# Mouser Electronics

Authorized Distributor

Click to View Pricing, Inventory, Delivery & Lifecycle Information:

## Carlo Gavazzi:

[GSB631PB10](#) [GSB631PC3](#) [GSB634PC2](#) [GSB633PB2](#) [GSB633PB50](#) [GSB633PB63](#) [GSB633PD40](#) [GSB633PD6](#)  
[GSB634PC10](#) [GSB631PD25](#) [GSB632PB10](#) [GSB632PB50](#) [GSB632PC16](#) [GSB632PD32](#) [GSB633PB10](#)  
[GSBBFEED23P](#) [GSBXF9](#) [GSBXF9J](#) [GSB631PC40](#) [GSB633PD4](#) [GSB634PB4](#) [GSB634PB50](#) [GSB634PB6](#)  
[GSB634PD10](#) [GSBB2P06H](#) [GSB631PD1](#) [GSB632PB2](#) [GSB632PB20](#) [GSB632PC40](#) [GSB633PB1](#) [GSB633PD32](#)  
[GSB634PD40](#) [GSBB3P12H](#) [GSBB3P57H](#) [GSB631PB4](#) [GSB631PB50](#) [GSB631PB6](#) [GSB633PC40](#) [GSB634PB1](#)  
[GSB634PB10](#) [GSB634PB2](#) [GSB634PD4](#) [GSB633PC6](#) [GSB633PC63](#) [GSB634PC3](#) [GSB634PD32](#) [GSB634PD50](#)  
[GSBB3P48HS](#) [GSB633PD50](#) [GSB634PC16](#) [GSB634PC6](#) [GSBB1P12H](#) [GSBB2P46HS](#) [GSBB3P06H](#) [GSB631PC50](#)  
[GSB632PB16](#) [GSB632PC2](#) [GSB632PC63](#) [GSB632PD4](#) [GSB633PC25](#) [GSB634PD16](#) [GSBB1P37HS](#)  
[GSBB1P57H](#) [GSBS9](#) [GSB631PC2](#) [GSB631PC4](#) [GSB633PB4](#) [GSB633PC2](#) [GSB633PC20](#) [GSB634PB40](#)  
[GSB634PC63](#) [GSB634PD1](#) [GSBB2P56H](#) [GSBBFEED1P](#) [GSB632PD2](#) [GSB633PB25](#) [GSB633PB3](#) [GSB634PC50](#)  
[GSB634PD20](#) [GSB634PD3](#) [GSB634PD6](#) [GSBB1P06H](#) [GSBB1P18H](#) [GSB631PC16](#) [GSB633PC3](#) [GSB634PB25](#)  
[GSB634PB32](#) [GSB634PB63](#) [GSB634PC4](#) [GSB634PD25](#) [GSBBCENFEED](#) [GSBBENDCAP23P](#) [GSB631PB3](#)  
[GSB633PD2](#) [GSB633PD63](#) [GSB634PB20](#) [GSB634PC1](#) [GSB634PD2](#) [GSB632PC25](#) [GSB632PD10](#)