

Maxi and Mini DC-DC Converter Evaluation Board

Features	1
Introduction	2
Set Up	
+ OUT, -OUT	3
+ S, -S	3
Secondary Control (SC)	3
Primary Control (PC)	4
Parallel (PR)	4
Input Fusing	4
Recommended Hardware	4
Thermals	5
Basic Evaluation	5
Output Voltage Measurement Jack (J1)	5
Input Current Measurement	6
Efficiency Measurement	6
Paralleling	6
Caution	9

Features

- Oscilloscope probe jack for output voltage and ripple measurements
- Provisions for fusing
- Bypass capacitors
- Kelvin voltage sense points
- Easy to parallel for higher power

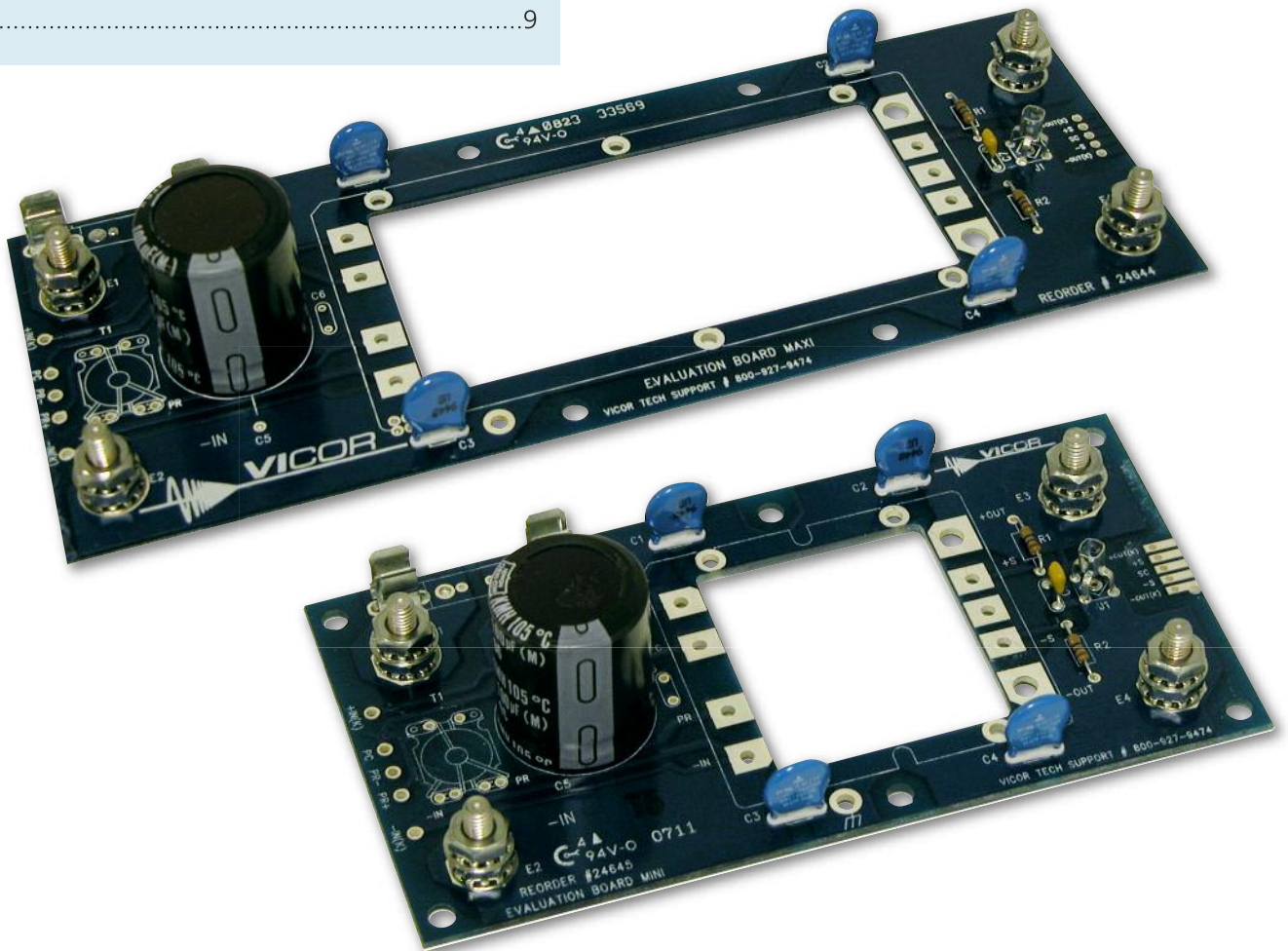

Introduction

The Maxi and Mini Evaluation Boards offer a convenient means to evaluate the performance of Vicor's DC-DC converters and have been optimized for user convenience. Refer to the appropriate DC-DC converter data sheet for performance and operating limits. The data sheets are available for downloading at www.vicorpower.com/dc-dc-converters-board-mount/maxi-mini-micro-dc-dc-converters.

It is important to remember the fast response of most DC-DC converters can readily show the limitations of the source, load, and associated wiring connected to the evaluation board. Care should be exercised to minimize stray source and load impedances in order to fully exercise the converter. Please refer to Figure 1 for locations of the input and output connections as viewed from the component side.

Set Up

The Customer Evaluation Board should be set up as follows:

Note: Care should be taken to avoid reversing polarities if connecting to the opposite (solder) side of the board.

+ IN, - IN

Connect a high-quality, low-noise power supply to the +IN and -IN terminals of the Evaluation Board. The interconnect leads should be heavy gauge and as short as possible. Additional capacitance may have to be added on the evaluation board to make up for impedances in the interconnect leads as well as deficiencies in the source. Kelvin connections -IN(K) and +IN(K) can be used to monitor the input and are located on the PCB adjacent to the input terminals.

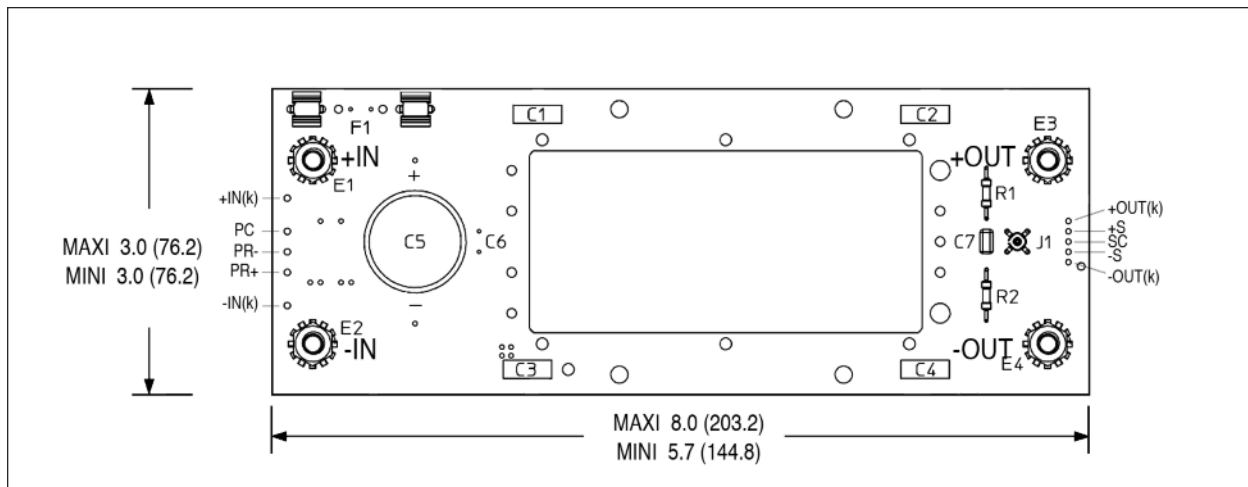

Figure 1: Maxi Evaluation Board layout and dimensional drawing, component side.



Figure 2: Basic Evaluation Board Connections, high voltage input and output

+ OUT, –OUT

An electronic or passive load should be connected to +OUT and –OUT terminals of the Evaluation Board with short heavy-gauge leads. Most commercially available electronic loads do not have current slew rates capable of fully exercising the converter. The Evaluation Board can be connected directly to the application for which the DC-DC converter is intended. However, the interconnect impedances between the Evaluation Board and the application can greatly affect the transient response. For applications where transient response is critical, the user should consider mounting the DC-DC converter directly to the target application PCB. Kelvin connections –OUT(K) and +OUT(K) can be used only to monitor the output and are located on the PCB adjacent to the output terminals. The output can also be monitored by using the scope jack J1.

+ S, –S

The sense leads should be connected to the point where the output voltage needs to be held constant. If the output leads are low impedance the sense leads may be directly connected to the output terminals of the evaluation board. Resistors R1 and R2 are included to terminate the sense lines should they be inadvertently left open.

Secondary Control (SC)

The SC pin can be used to modify the output voltage set point. This pin can be left open if the nominal output voltage is desired. Attaching an appropriate value resistor between the SC pin and the –S pin of the converter will trim the output down. A resistor from +Out will trim the output voltage up. See the Maxi, Mini, Micro Design Guide and Applications Manual or use the online calculator for trim resistor values at www.vicorpower.com/powerbench/product-calculators.

Primary Control (PC)

PC can be used to disable the DC-DC converter or can function as a 6 V auxiliary supply. Common connections are as follows:

- Connecting PC to the –IN will disable the DC-DC Converter.
- Connecting a DVM or oscilloscope between PC (positive) and –IN (negative) will indicate the status of the converter. This requires that a 10 k Ω pull down resistor be added from PC to –IN as the PC pin does not have active pulldown.

Parallel (PR)

The PR pin is used to control load sharing in parallel arrays. The voltage at this pin pulses at the switching frequency of the DC-DC converter. It should be left open when evaluating a single module. The Evaluation Board has a footprint for the addition of a PR coupling transformer to create parallel arrays with fully isolated inputs.

For further information on the function and proper use of module control pins refer to the Maxi, Mini, Micro, Design Guide and Applications Manual. This is available for downloading at www.vicorpower.com/dc-dc-converters-board-mount/maxi-mini-micro-dc-dc-converters.

Input Fusing

Warning: A fuse is required to provide protection in the event of a module failure. Safety agency conditions of acceptability require that the module positive input terminal be fused.

For acceptable input fuses see the Design Requirements sections of the Maxi, Mini, Micro Design Guide and Applications Manual. If a 3AG fuse is required use the fuse holder located on the corner of the Evaluation Board as shown in Figure 3. A location is also provided for soldering a PC-Tron fuse in place, see Figure 4.

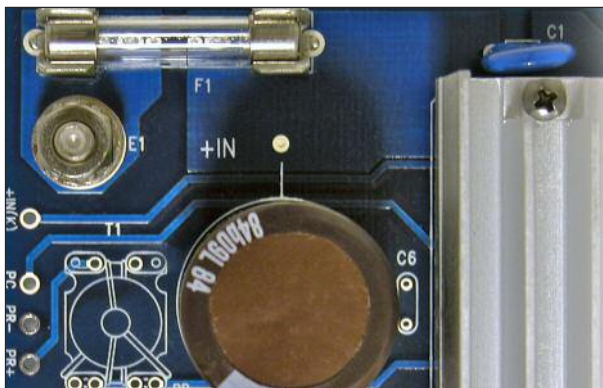

Figure 3: Fuse installation for 3AG

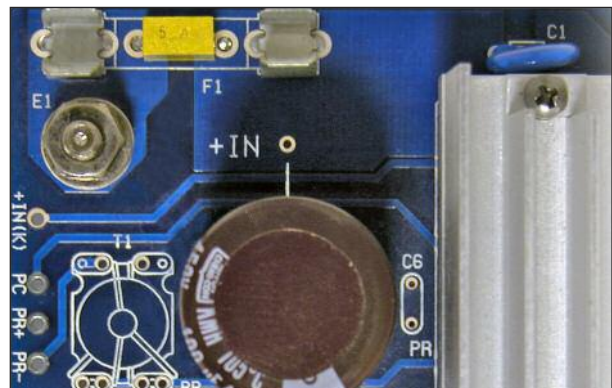

Figure 4: Fuse installation for PC-Tron

Thermals

For most lab environments a fan blowing across the evaluation board and appropriate heat sinking is recommended. A variety of heat sinks are available from Vicor. See Figure 4 for the proper installation of the converter and heat sink.

For additional information on thermal management refer to the application note "Thermal Considerations: Assuring Performance of Maxi, Mini and Micro High-Density DC-DC Converter Modules" and the Maxi, Mini, Micro Design Guide and Applications Manual.

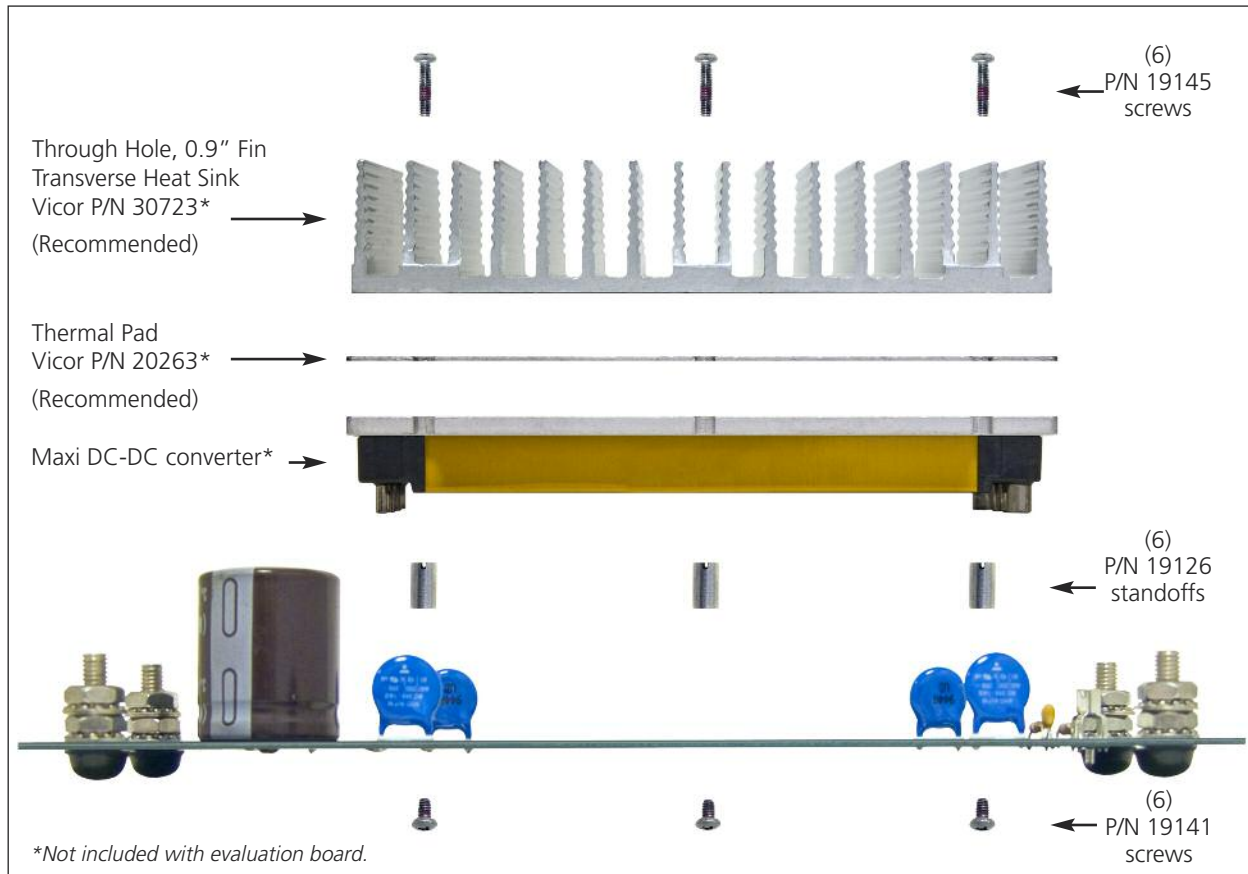

Figure 4: Heat sink installation stackup

Recommended Hardware

Mounting hardware included with the Evaluation Board is compatible with slotted baseplate converters only. The provided hardware includes:

Quantity	Description	
6	0.325" F-F standoff	} Vicor P/N 18150
6	4-40, 3/16" screw	
6	4-40, 1/2" screw	
6	Self adhesive rubber foot	
12	0.44 OD 0.203 ID brass washer	
8	10-32 hex nut with star lock washer	
4	4-40, 5/16" screw	

Ring lugs are also recommended.

Basic Evaluation

Output Voltage Measurement Jack (J1)

This connector is provided to make accurate measurements of the output voltage of the DC-DC converter. Many types of scope probes may be directly connected to this point if the probe is equipped with a removable plastic sheath. To avoid creating ground loops when making measurements of the output or input voltage, these measurements should be made separately.

Input Current Measurement

A current probe can be passed around the +IN lead connected to the converter. Input capacitors on the Evaluation Board are downstream of this measurement point.

Efficiency Measurement

As the Maxi and Mini DC-DC converter can deliver and consume large currents, the effect of the PCB must be considered when making an efficiency measurement. Be certain to accurately measure the voltage directly at the DC-DC converter using the provided Kelvin input and output connections.

Paralleling

There are several suggested configurations for paralleling Vicor converters. The most appropriate will depend on the application. To parallel two converters in a democratic array with isolated PR bus use the following procedure. Paralleling more than two evaluation boards is not recommended.

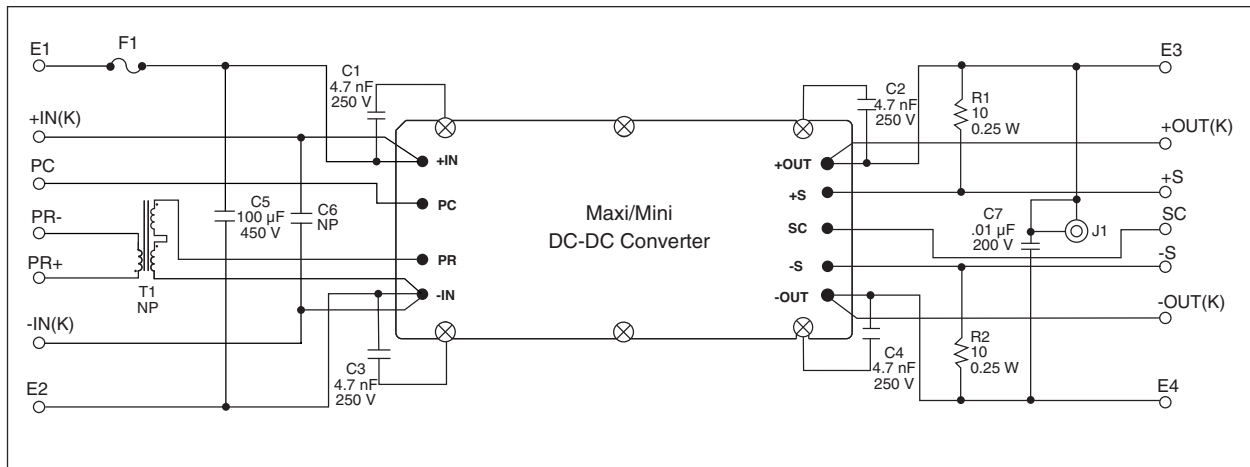

Figure 5: Maxi and Mini DC-DC converter Evaluation Board schematic



Figure 6: Paralleled Evaluation Board, wire gage is suitable for high input and output voltage converters

1. Add PR coupling transformers (Vicor P/N 29768) in the space provided on the input side of two Evaluation Boards. The same model of converter must be installed in each board along with an appropriate input fuse.

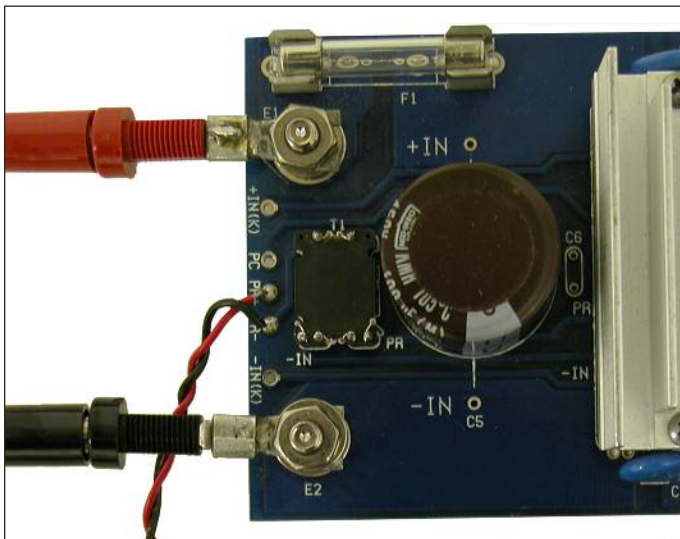

Figure 7: PR transformer and isolated PR bus

2. Connect the PR+ of the first board to the PR+ of the second board with one half of a short section of twisted pair. With the other half do the same for the PR- of the Evaluating Boards, Figure 7. The PR signal is a very fast pulse and requires a interconnect with good signal integrity. Do not use coaxial cable for the interconnect.
3. Connect the inputs and outputs of the evaluation boards in parallel with appropriately sized leads.
4. Remove the 10 Ω protection resistors (R1 and R2) from each evaluation boards. This enables full remote sensing, which is required for proper converter arbitration.
5. Connect a twisted pair to the +S and –S connections on the output side of each evaluation board. It is critical that these two wire pairs are both terminated at the same point for proper load sharing, Figure 8.

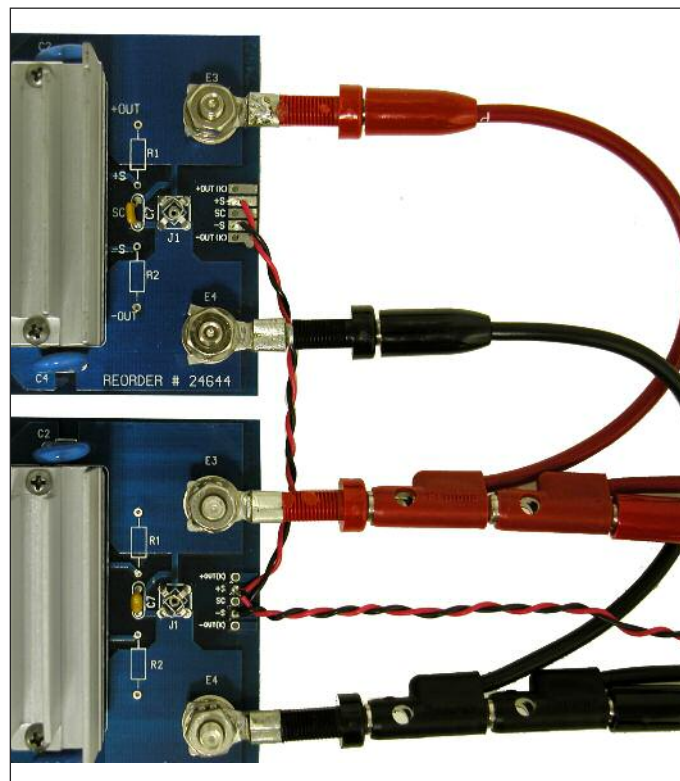

Figure 8: Sense line termination, sense lines end at a common point

To test the array, verify that both converters provide roughly half the load current. The array will be capable of producing twice the power of an individual converter.

For other paralleling configurations and procedures see the Maxi, Mini, Micro, Design Guide and Applications Manual.

Caution

The Maxi/Mini DC-DC converter and Evaluation Board can comfortably operate at surface temperatures which may pose a thermal hazard to the operator. Be careful not to touch any exposed surface. The Evaluation Board is not intended for use in end item equipment.

Maxi and Mini DC-DC converters operate at hazardous voltages that will be present at the surface of the Evaluation Board. Proper safety steps should be taken when using the Evaluation Board.

For further information on evaluation boards contact Vicor Applications Engineers at 1-800-927-9474 or vicorpower.com/support/ for worldwide assistance.

Mouser Electronics

Authorized Distributor

Click to View Pricing, Inventory, Delivery & Lifecycle Information:

[Vicor:](#)

[24644R](#)