

**Features**

- Advanced Process Technology
- Ultra Low On-Resistance
- 175°C Operating Temperature
- Fast Switching
- Repetitive Avalanche Allowed up to Tjmax
- Lead-Free

**Description**

This HEXFET® Power MOSFET utilizes the latest processing techniques to achieve extremely low on-resistance per silicon area. Additional features of this design are a 175°C junction operating temperature, fast switching speed and improved repetitive avalanche rating. These features combine to make this design an extremely efficient and reliable device for use in a wide variety of applications.

HEXFET® Power MOSFET

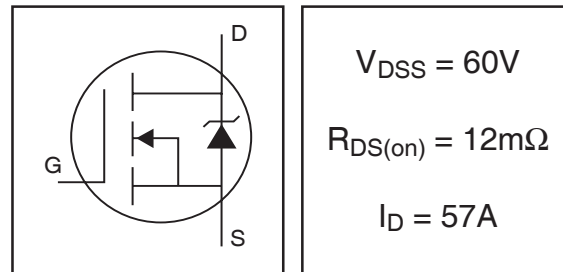

$V_{DSS} = 60V$   
 $R_{DS(on)} = 12m\Omega$   
 $I_D = 57A$

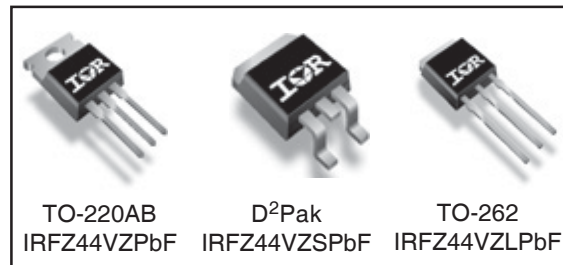

**Absolute Maximum Ratings**

|                              | Parameter  | Max.                     | Units |
|------------------------------|--|--------------------------|-------|
| $I_D @ T_C = 25^\circ C$     | Continuous Drain Current, $V_{GS} @ 10V$ (Silicon Limited) | 57                       | A     |
| $I_D @ T_C = 100^\circ C$    | Continuous Drain Current, $V_{GS} @ 10V$                   | 40                       |       |
| $I_{DM}$                     | Pulsed Drain Current ①                                     | 230                      |       |
| $P_D @ T_C = 25^\circ C$     | Power Dissipation  | 92                       | W     |
|                              | Linear Derating Factor                                     | 0.61                     | W/°C  |
| $V_{GS}$                     | Gate-to-Source Voltage                                     | $\pm 20$                 | V     |
| $E_{AS}$ (Thermally limited) | Single Pulse Avalanche Energy ②                            | 73                       | mJ    |
| $E_{AS}$ (Tested )           | Single Pulse Avalanche Energy Tested Value ③               | 110                      |       |
| $I_{AR}$                     | Avalanche Current ④  | See Fig.12a, 12b, 15, 16 | A     |
| $E_{AR}$                     | Repetitive Avalanche Energy ⑤                              |                          | mJ    |
| $T_J$                        | Operating Junction and                                     | -55 to + 175             | °C    |
| $T_{STG}$                    | Storage Temperature Range                                  |                          |       |
|                              | Soldering Temperature, for 10 seconds                      | 300 (1.6mm from case )   |       |
|                              | Mounting Torque, 6-32 or M3 screw ⑦                        | 10 lbf•in (1.1N•m)       |       |

**Thermal Resistance**

|                 | Parameter                            | Typ. | Max. | Units |
|-----------------|--------------------------------------|------|------|-------|
| $R_{\theta JC}$ | Junction-to-Case                     | —    | 1.64 | °C/W  |
| $R_{\theta CS}$ | Case-to-Sink, Flat Greased Surface ⑧ | 0.50 | —    |       |
| $R_{\theta JA}$ | Junction-to-Ambient ⑨                | —    | 62   |       |
| $R_{\theta JA}$ | Junction-to-Ambient (PCB Mount) ⑩    | —    | 40   |       |

# IRFZ44VZS/LPbF

International  
IR Rectifier

## Electrical Characteristics @ $T_J = 25^\circ\text{C}$ (unless otherwise specified)

|                                 | Parameter                            | Min. | Typ.  | Max. | Units      | Conditions  |
|---------------------------------|--------------------------------------|------|-------|------|------------|---|
| $V_{(BR)DSS}$                   | Drain-to-Source Breakdown Voltage    | 60   | —     | —    | V          | $V_{GS} = 0V, I_D = 250\mu A$   |
| $\Delta V_{(BR)DSS}/\Delta T_J$ | Breakdown Voltage Temp. Coefficient  | —    | 0.061 | —    | V/°C       | Reference to $25^\circ\text{C}$ , $I_D = 1\text{mA}$                        |
| $R_{DS(on)}$                    | Static Drain-to-Source On-Resistance | —    | 9.6   | 12   | m $\Omega$ | $V_{GS} = 10V, I_D = 34A$ ③   |
| $V_{GS(th)}$                    | Gate Threshold Voltage               | 2.0  | —     | 4.0  | V          | $V_{DS} = V_{GS}, I_D = 250\mu A$   |
| $g_{fs}$                        | Forward Transconductance             | 25   | —     | —    | V          | $V_{DS} = 25V, I_D = 34A$   |
| $I_{DSS}$                       | Drain-to-Source Leakage Current      | —    | —     | 20   | $\mu A$    | $V_{DS} = 60V, V_{GS} = 0V$   |
|                                 |                                      | —    | —     | 250  |            | $V_{DS} = 60V, V_{GS} = 0V, T_J = 125^\circ\text{C}$                        |
| $I_{GSS}$                       | Gate-to-Source Forward Leakage       | —    | —     | 200  | nA         | $V_{GS} = 20V$  |
|                                 | Gate-to-Source Reverse Leakage       | —    | —     | -200 |            | $V_{GS} = -20V$   |
| $Q_g$                           | Total Gate Charge                    | —    | 43    | 65   | nC         | $I_D = 34A$   |
| $Q_{gs}$                        | Gate-to-Source Charge                | —    | 11    | —    |            | $V_{DS} = 48V$  |
| $Q_{gd}$                        | Gate-to-Drain ("Miller") Charge      | —    | 18    | —    |            | $V_{GS} = 10V$ ③  |
| $t_{d(on)}$                     | Turn-On Delay Time                   | —    | 14    | —    | ns         | $V_{DD} = 30V$  |
| $t_r$                           | Rise Time                            | —    | 62    | —    |            | $I_D = 34A$   |
| $t_{d(off)}$                    | Turn-Off Delay Time                  | —    | 35    | —    |            | $R_G = 12\ \Omega$  |
| $t_f$                           | Fall Time                            | —    | 38    | —    |            | $V_{GS} = 10V$ ③  |
| $L_D$                           | Internal Drain Inductance            | —    | 4.5   | —    | nH         | Between lead,<br>6mm (0.25in.)<br>from package<br>and center of die contact |
| $L_S$                           | Internal Source Inductance           | —    | 7.5   | —    |            |   |
| $C_{iss}$                       | Input Capacitance                    | —    | 1690  | —    | pF         | $V_{GS} = 0V$   |
| $C_{oss}$                       | Output Capacitance                   | —    | 270   | —    |            | $V_{DS} = 25V$  |
| $C_{rss}$                       | Reverse Transfer Capacitance         | —    | 130   | —    |            | $f = 1.0\text{MHz}$   |
| $C_{oss}$                       | Output Capacitance                   | —    | 1870  | —    |            | $V_{GS} = 0V, V_{DS} = 1.0V, f = 1.0\text{MHz}$                             |
| $C_{oss}$                       | Output Capacitance                   | —    | 260   | —    |            | $V_{GS} = 0V, V_{DS} = 48V, f = 1.0\text{MHz}$                              |
| $C_{oss\ eff.}$                 | Effective Output Capacitance         | —    | 510   | —    |            | $V_{GS} = 0V, V_{DS} = 0V\ \text{to}\ 48V$ ④                                |

## Source-Drain Ratings and Characteristics

|          | Parameter                                 | Min.  | Typ. | Max. | Units | Conditions  |
|----------|---|---|------|------|-------|---|
| $I_S$    | Continuous Source Current<br>(Body Diode) | —   | —    | 57   | A     | MOSFET symbol<br>showing the<br>integral reverse<br>p-n junction diode. |
| $I_{SM}$ | Pulsed Source Current<br>(Body Diode) ①   | —   | —    | 230  |       |   |
| $V_{SD}$ | Diode Forward Voltage                     | —   | —    | 1.3  | V     | $T_J = 25^\circ\text{C}, I_S = 34A, V_{GS} = 0V$ ③                      |
| $t_{rr}$ | Reverse Recovery Time                     | —   | 23   | 35   | ns    | $T_J = 25^\circ\text{C}, I_F = 34A, V_{DD} = 30V$                       |
| $Q_{rr}$ | Reverse Recovery Charge                   | —   | 17   | 26   | nC    | $di/dt = 100A/\mu s$ ③  |
| $t_{on}$ | Forward Turn-On Time                      | Intrinsic turn-on time is negligible (turn-on is dominated by $L_S+L_D$ ) |      |      |       |   |

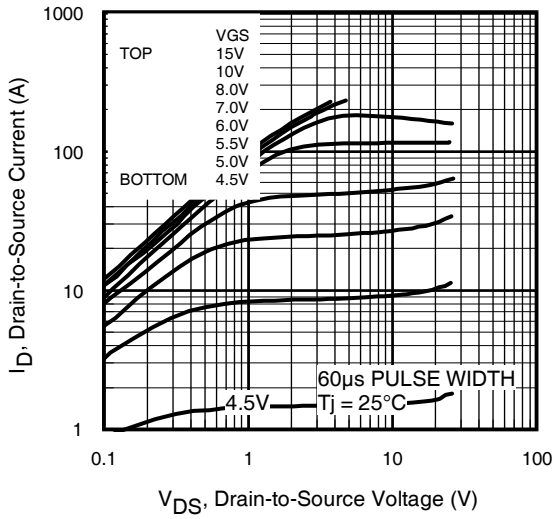

Fig 1. Typical Output Characteristics

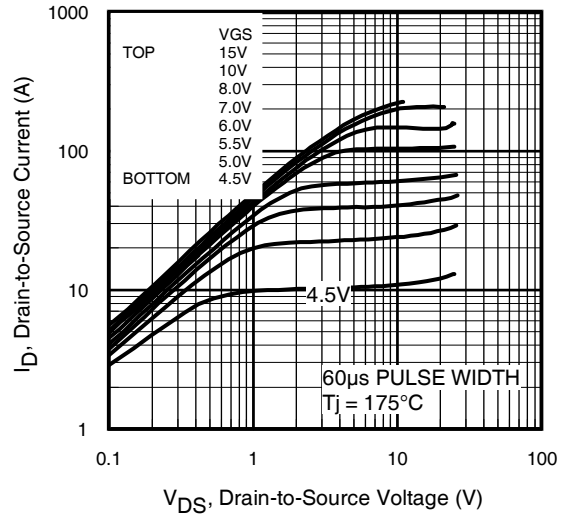

Fig 2. Typical Output Characteristics

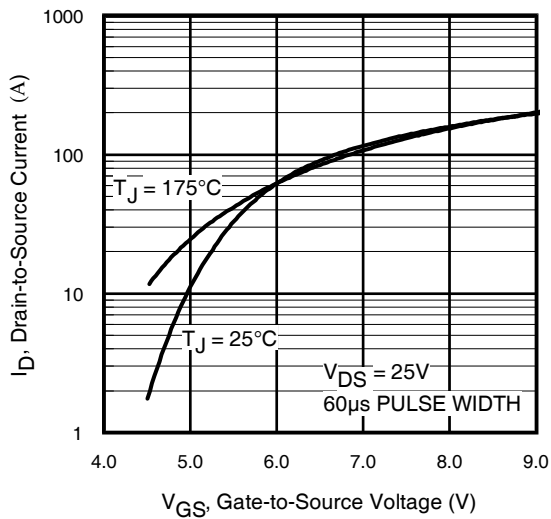

Fig 3. Typical Transfer Characteristics

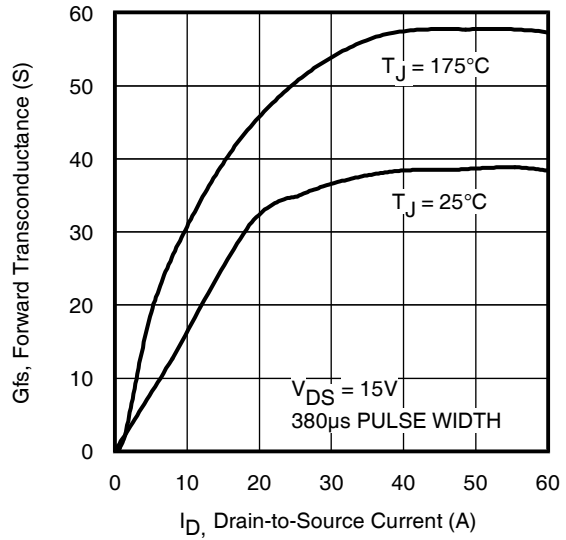
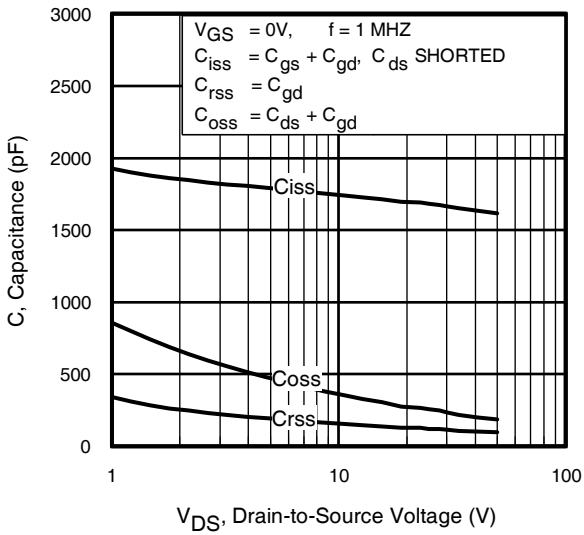
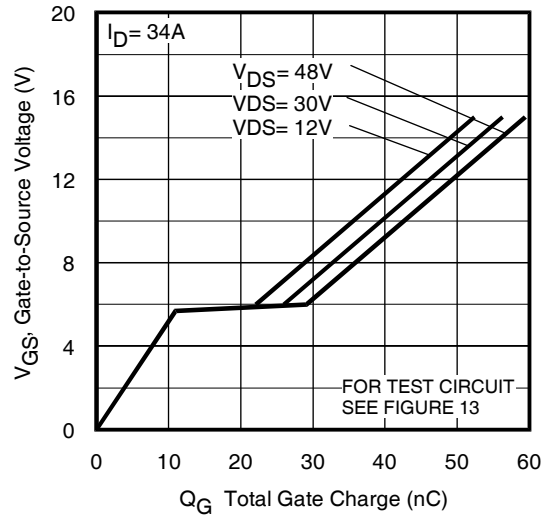

Fig 4. Typical Forward Transconductance Vs. Drain Current

# IRFZ44VZS/LPbF



**Fig 5.** Typical Capacitance Vs. Drain-to-Source Voltage



**Fig 6.** Typical Gate Charge Vs. Gate-to-Source Voltage

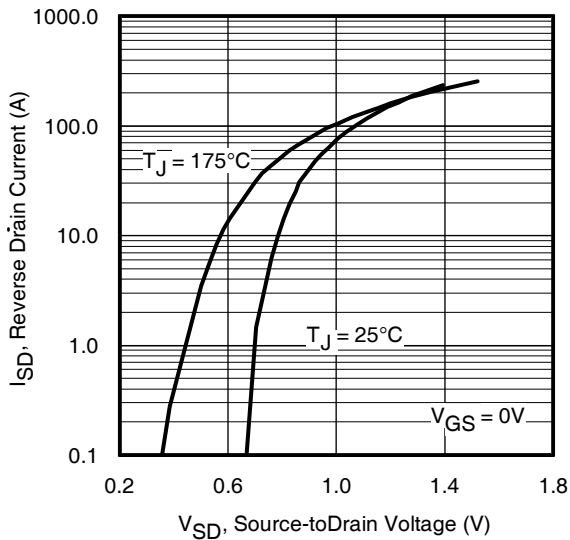

**Fig 7.** Typical Source-Drain Diode Forward Voltage

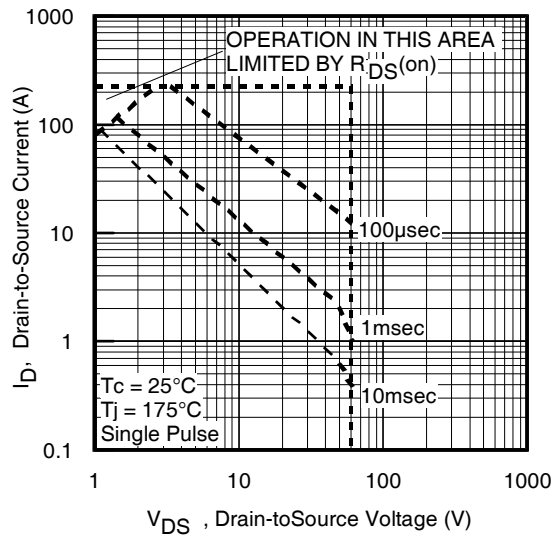

**Fig 8.** Maximum Safe Operating Area

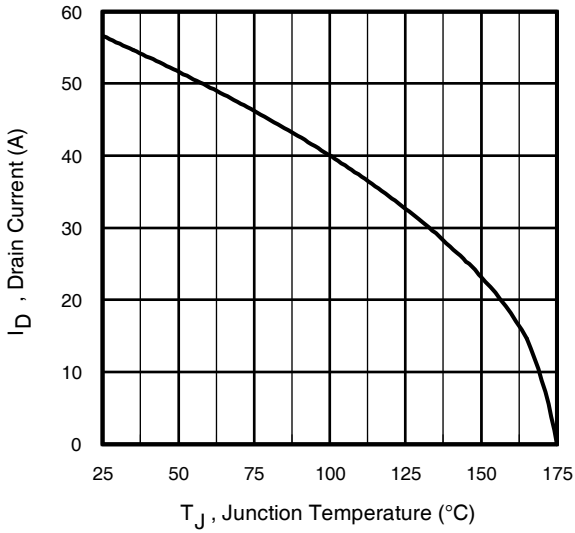

**Fig 9.** Maximum Drain Current Vs. Case Temperature

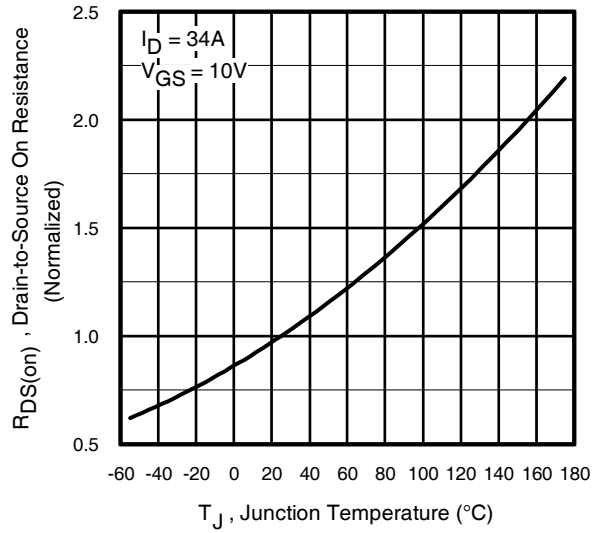

**Fig 10.** Normalized On-Resistance Vs. Temperature

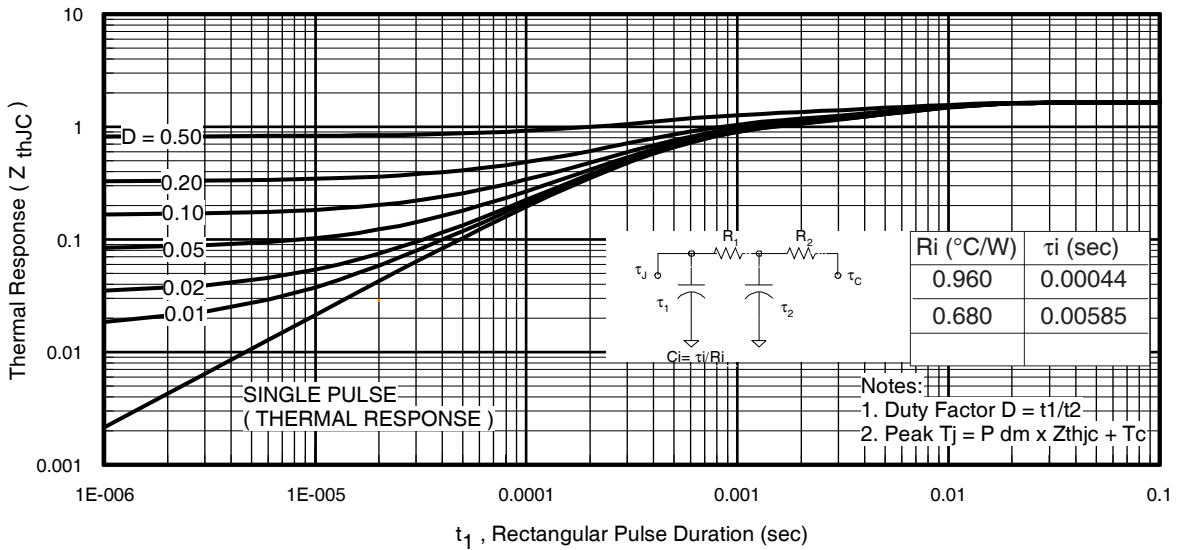

**Fig 11.** Maximum Effective Transient Thermal Impedance, Junction-to-Case

# IRFZ44VZS/LPbF



**Fig 12a.** Unclamped Inductive Test Circuit



**Fig 12b.** Unclamped Inductive Waveforms

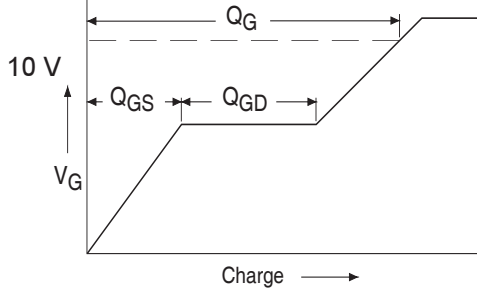

**Fig 13a.** Basic Gate Charge Waveform

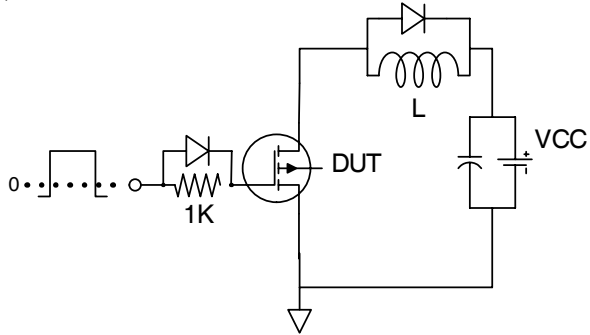

**Fig 13b.** Gate Charge Test Circuit

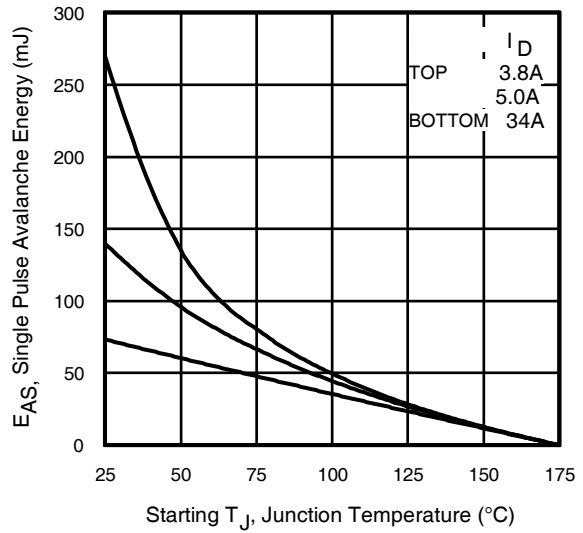

**Fig 12c.** Maximum Avalanche Energy Vs. Drain Current

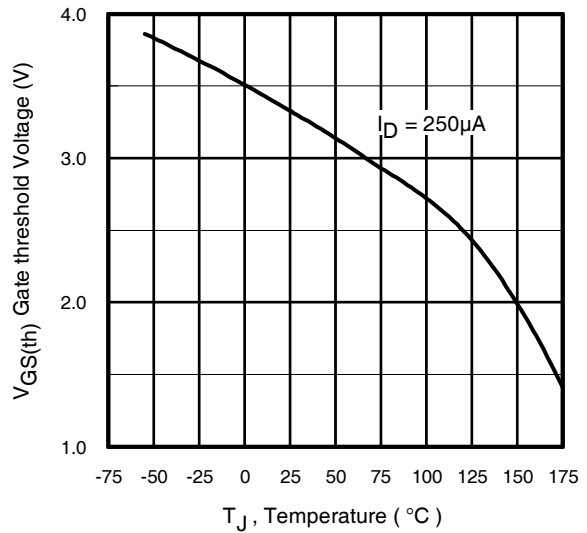

**Fig 14.** Threshold Voltage Vs. Temperature

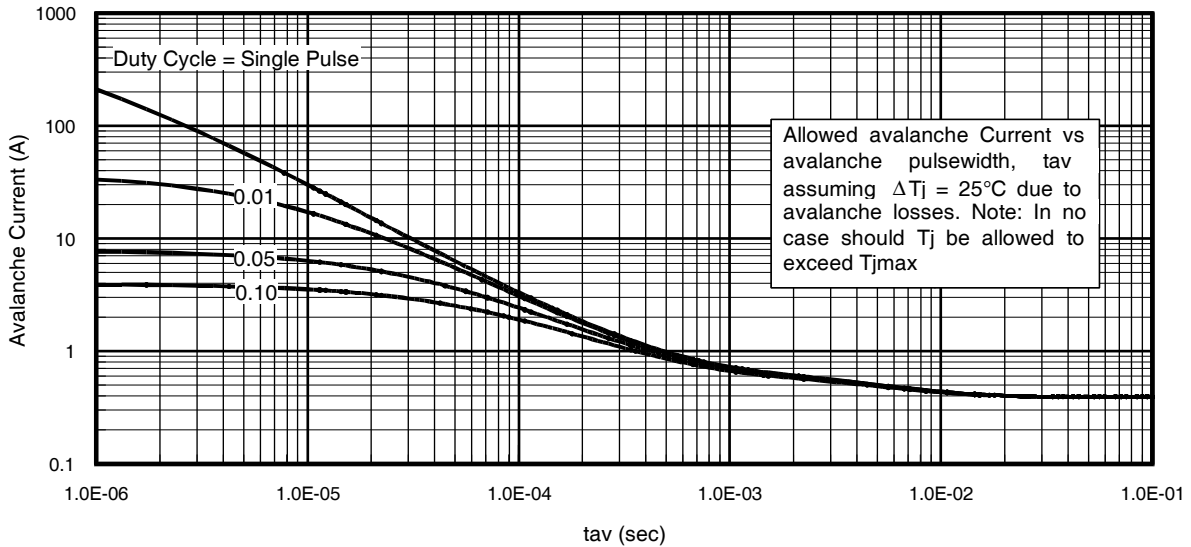

Fig 15. Typical Avalanche Current Vs.Pulsewidth

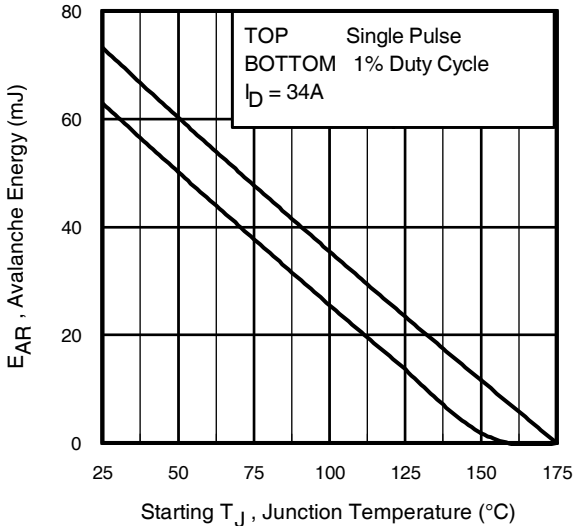

Fig 16. Maximum Avalanche Energy Vs. Temperature

**Notes on Repetitive Avalanche Curves , Figures 15, 16:**  
(For further info, see AN-1005 at [www.irf.com](http://www.irf.com))

1. Avalanche failures assumption:  
Purely a thermal phenomenon and failure occurs at a temperature far in excess of  $T_{jmax}$ . This is validated for every part type.
2. Safe operation in Avalanche is allowed as long as  $T_{jmax}$  is not exceeded.
3. Equation below based on circuit and waveforms shown in Figures 12a, 12b.
4.  $P_{D(ave)}$  = Average power dissipation per single avalanche pulse.
5. BV = Rated breakdown voltage (1.3 factor accounts for voltage increase during avalanche).
6.  $I_{av}$  = Allowable avalanche current.
7.  $\Delta T$  = Allowable rise in junction temperature, not to exceed  $T_{jmax}$  (assumed as 25°C in Figure 15, 16).  
 $t_{av}$  = Average time in avalanche.  
 $D$  = Duty cycle in avalanche =  $t_{av} \cdot f$   
 $Z_{thJC}(D, t_{av})$  = Transient thermal resistance, see figure 11)

$$P_{D(ave)} = 1/2 ( 1.3 \cdot BV \cdot I_{av} ) = \Delta T / Z_{thJC}$$

$$I_{av} = 2\Delta T / [1.3 \cdot BV \cdot Z_{th}]$$

$$E_{AS(AR)} = P_{D(ave)} \cdot t_{av}$$



**Fig 17. Peak Diode Recovery  $dv/dt$  Test Circuit for N-Channel HEXFET® Power MOSFETs**

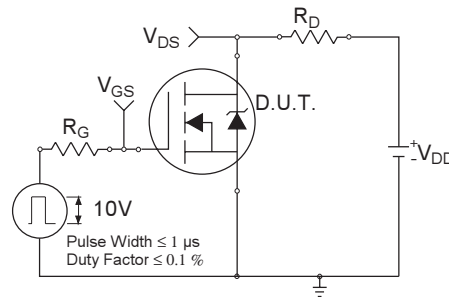

**Fig 18a. Switching Time Test Circuit**

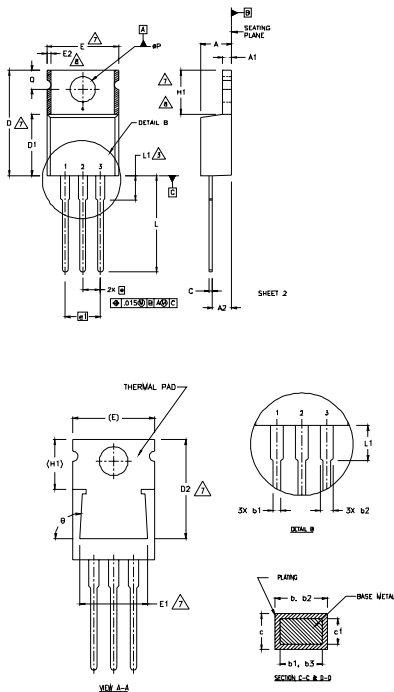

**Fig 18b. Switching Time Waveforms**



## TO-220AB Package Outline

Dimensions are shown in millimeters (inches)



- NOTES:
- 1 DIMENSIONING AND TOLERANCING PER ASME Y14.5 M- 1994.
  - 2 DIMENSIONS ARE SHOWN IN INCHES [MILLIMETERS].
  - 3 LEAD DIMENSION AND FINISH UNCONTROLLED IN L1.
  - 4 DIMENSION D & E DO NOT INCLUDE MOLD FLASH. MOLD FLASH SHALL NOT EXCEED .005" (0.127) PER SIDE. THESE DIMENSIONS ARE MEASURED AT THE OUTERMOST EXTREMES OF THE PLASTIC BODY.
  - 5 DIMENSION b1 & c1 APPLY TO BASE METAL ONLY.
  - 6 CONTROLLING DIMENSION - INCHES.
  - 7 THERMAL PAD CONTOUR OPTIONAL WITHIN DIMENSIONS E,H1,D2 & E1
  - 8 DIMENSION E2 X H1 DEFINE A ZONE WHERE STAMPING AND SINGULATION IRREGULARITIES ARE ALLOWED.

LEAD ASSIGNMENTS

- HEBEE  
1 - GATE  
2 - DRAIN  
3 - SOURCE

IGBLS\_CoPACK

- 1 - GATE  
2 - COLLECTOR  
3 - EMITTER

ROBBS

- 1 - ANODE/OPEN  
2 - CATHODE  
3 - ANODE

| SYMBOL | DIMENSIONS  |       |          |      | NOTES |
|--------|-------------|-------|----------|------|-------|
|        | MILLIMETERS |       | INCHES   |      |       |
|        | MIN.        | MAX.  | MIN.     | MAX. |       |
| A      | 3.56        | 4.82  | .140     | .190 |       |
| A1     | 0.51        | 1.40  | .020     | .055 |       |
| A2     | 2.04        | 2.92  | .080     | .115 |       |
| b      | 0.38        | 1.01  | .015     | .040 |       |
| b1     | 0.38        | 0.96  | .015     | .038 | 5     |
| b2     | 1.15        | 1.77  | .045     | .070 |       |
| b3     | 1.15        | 1.73  | .045     | .068 |       |
| c      | 0.36        | 0.61  | .014     | .024 |       |
| c1     | 0.36        | 0.56  | .014     | .022 | 5     |
| D      | 14.22       | 16.51 | .560     | .650 | 4     |
| D1     | 8.38        | 9.02  | .330     | .355 |       |
| D2     | 12.19       | 12.88 | .480     | .507 | 7     |
| E      | 9.66        | 10.66 | .380     | .420 | 4,7   |
| E1     | 8.38        | 8.89  | .330     | .350 | 7     |
| e      | 2.54 BSC    |       | .100 BSC |      |       |
| e1     | 5.08        |       | .200 BSC |      |       |
| H1     | 5.85        | 6.55  | .230     | .270 | 7,8   |
| L      | 12.70       | 14.73 | .500     | .580 |       |
| L1     | -           | 6.35  | -        | .250 | 3     |
| pP     | 3.54        | 4.08  | .139     | .161 |       |
| Q      | 2.54        | 3.42  | .100     | .135 |       |
| θ      | 90°-93°     |       | 90°-93°  |      |       |

## TO-220AB Part Marking Information

EXAMPLE: THIS IS AN IRF1010  
LOT CODE 1789  
ASSEMBLED ON WW 19, 2000  
IN THE ASSEMBLY LINE "C"

Note: "P" in assembly line position  
indicates "Lead-Free"

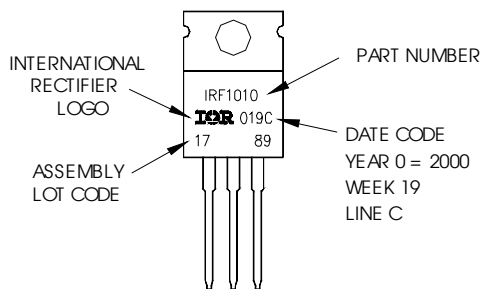

Notes:

1. For an Automotive Qualified version of this part please see <http://www.irf.com/product-info/auto/>
2. For the most current drawing please refer to IR website at <http://www.irf.com/package/>

# IRFZ44VZS/LPbF

International  
**IR** Rectifier

## D<sup>2</sup>Pak (TO-263AB) Package Outline

Dimensions are shown in millimeters (inches)

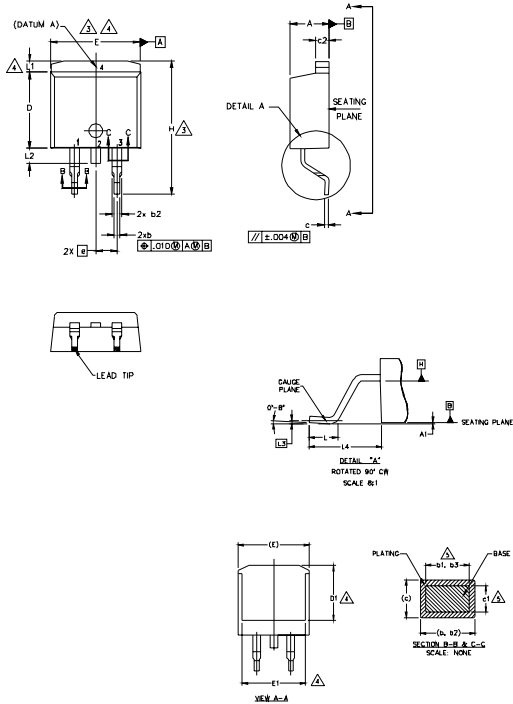

- NOTES:
1. DIMENSIONING AND TOLERANCING PER ASME Y14.5M-1994
  2. DIMENSIONS ARE SHOWN IN MILLIMETERS (INCHES).
  3. DIMENSION D & E DO NOT INCLUDE MOLD FLASH. MOLD FLASH SHALL NOT EXCEED 0.127 (.005") PER SIDE. THESE DIMENSIONS ARE MEASURED AT THE OUTMOST EXTREMES OF THE PLASTIC BODY AT DATUM H.
  4. THERMAL PAD CONTOUR OPTIONAL WITHIN DIMENSION E, L1, D1 & E1.
  5. DIMENSION b1 AND c1 APPLY TO BASE METAL ONLY.
  6. DATUM A & B TO BE DETERMINED AT DATUM PLANE H.
  7. CONTROLLING DIMENSION: INCH.
  8. OUTLINE CONFORMS TO JEDEC OUTLINE TO-263AB.

| SYMBOL | DIMENSIONS  |       |          |      | NOTES |
|--------|-------------|-------|----------|------|-------|
|        | MILLIMETERS |       | INCHES   |      |       |
|        | MIN.        | MAX.  | MIN.     | MAX. |       |
| A      | 4.06        | 4.83  | .160     | .190 | 5     |
| A1     | 0.00        | 0.254 | .000     | .010 |       |
| b      | 0.51        | 0.99  | .020     | .039 |       |
| b1     | 0.51        | 0.89  | .020     | .035 | 5     |
| b2     | 1.14        | 1.78  | .045     | .070 |       |
| b3     | 1.14        | 1.73  | .045     | .068 |       |
| c      | 0.38        | 0.74  | .015     | .029 | 5     |
| c1     | 0.38        | 0.58  | .015     | .023 |       |
| c2     | 1.14        | 1.65  | .045     | .065 |       |
| D      | 8.38        | 9.65  | .330     | .380 | 3     |
| D1     | 6.86        | -     | .270     | -    |       |
| E      | 9.65        | 10.67 | .380     | .420 | 3,4   |
| E1     | 6.22        | -     | .245     | -    |       |
| e      | 2.54 BSC    |       | .100 BSC |      | 4     |
| H      | 14.61       | 15.88 | .575     | .625 |       |
| L      | 1.78        | 2.79  | .070     | .110 |       |
| L1     | -           | 1.65  | -        | .066 |       |
| L2     | 1.27        | 1.78  | -        | .070 |       |
| L3     | 0.25 BSC    |       | .010 BSC |      |       |
| L4     | 4.78        | 5.28  | .188     | .208 |       |

### LEAD ASSIGNMENTS

#### HEXFET

- 1.- GATE
2. 4.- DRAIN
- 3.- SOURCE

#### IGBTs, CoPACK

- 1.- GATE
2. 4.- COLLECTOR
- 3.- EMITTER

#### DIODES

- 1.- ANODE \*
2. 4.- CATHODE
- 3.- ANODE

\* PART DEPENDENT.

## D<sup>2</sup>Pak (TO-263AB) Part Marking Information

EXAMPLE: THIS IS AN IRF530S WITH  
LOT CODE 8024  
ASSEMBLED ON WW 02, 2000  
IN THE ASSEMBLY LINE "L"

Note: "P" in assembly line position  
indicates "Lead - Free"

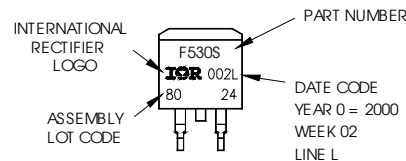

OR

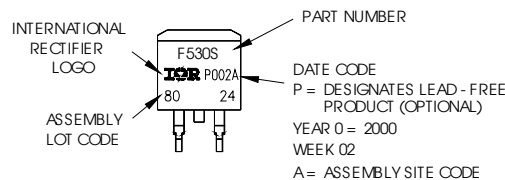

### Notes:

1. For an Automotive Qualified version of this part please see <http://www.irf.com/product-info/auto/>
2. For the most current drawing please refer to IR website at <http://www.irf.com/package/>

## TO-262 Package Outline

Dimensions are shown in millimeters (inches)

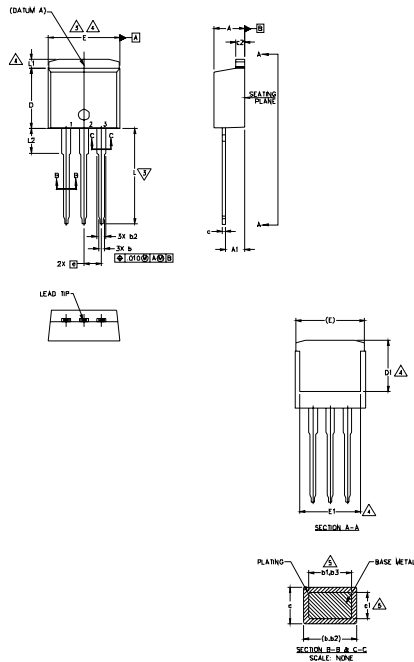

**NOTES:**

1. DIMENSIONING AND TOLERANCING PER ASME Y14.5M-1994
2. DIMENSIONS ARE SHOWN IN MILLIMETERS [INCHES]
3. DIMENSION D & E DO NOT INCLUDE MOLD FLASH. MOLD FLASH SHALL NOT EXCEED 0.127 [0.005"] PER SIDE. THESE DIMENSIONS ARE MEASURED AT THE OUTMOST EXTREMES OF THE PLASTIC BODY.
4. THERMAL PAD CONTOUR OPTIONAL WITHIN DIMENSION E, L1, D1 & E1.
5. DIMENSION b1 AND c1 APPLY TO BASE METAL ONLY.
6. CONTROLLING DIMENSION: INCH.
7. OUTLINE CONFORM TO JEDEC TO-262 EXCEPT A1(max.), b(min.) AND D1(min.) WHERE DIMENSIONS DERIVED THE ACTUAL PACKAGE OUTLINE.

| SYMBOL | DIMENSIONS  |       |        |      | NOTES |
|--------|-------------|-------|--------|------|-------|
|        | MILLIMETERS |       | INCHES |      |       |
|        | MIN.        | MAX.  | MIN.   | MAX. |       |
| A      | 4.06        | 4.83  | .160   | .190 |       |
| A1     | 2.03        | 3.02  | .080   | .119 |       |
| b      | 0.51        | 0.99  | .020   | .039 |       |
| b1     | 0.51        | 0.89  | .020   | .035 | 5     |
| b2     | 1.14        | 1.78  | .045   | .070 |       |
| b3     | 1.14        | 1.73  | .045   | .068 | 5     |
| c      | 0.38        | 0.74  | .015   | .029 |       |
| c1     | 0.38        | 0.58  | .015   | .023 | 5     |
| c2     | 1.14        | 1.65  | .045   | .065 |       |
| D      | 8.38        | 9.65  | .330   | .380 | 3     |
| D1     | 6.86        | -     | .270   | -    | 4     |
| E      | 9.65        | 10.67 | .380   | .420 | 3,4   |
| E1     | 6.22        | -     | .245   | -    | 4     |
| e      | 2.54        | BSC   | .100   | BSC  |       |
| L      | 13.46       | 14.10 | .530   | .555 |       |
| L1     | -           | 1.65  | -      | .065 |       |
| L2     | 3.56        | 3.71  | .140   | .146 | 4     |

LEAD ASSIGNMENTS

HEXFET

- 1.- GATE
- 2.- DRAIN
- 3.- SOURCE
- 4.- DRAIN

IGBTs, CoPACK

- 1.- GATE
- 2.- COLLECTOR
- 3.- EMITTER
- 4.- COLLECTOR

## TO-262 Part Marking Information

EXAMPLE: THIS IS AN IRL3103L  
LOT CODE 1789  
ASSEMBLED ON WW 19, 1997  
IN THE ASSEMBLY LINE "C"

Note: "P" in assembly line position  
indicates "Lead - Free"

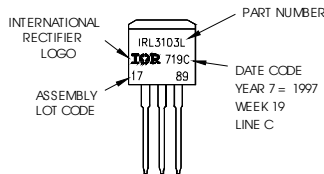

OR

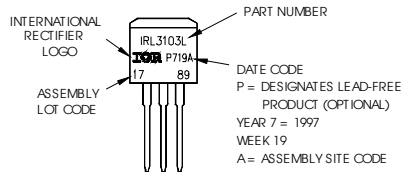

**Notes:**

1. For an Automotive Qualified version of this part please see <http://www.irf.com/product-info/auto/>
2. For the most current drawing please refer to IR website at <http://www.irf.com/package/>

# IRFZ44VZS/LPbF

International  
**IR** Rectifier

## D<sup>2</sup>Pak Tape & Reel Infomation

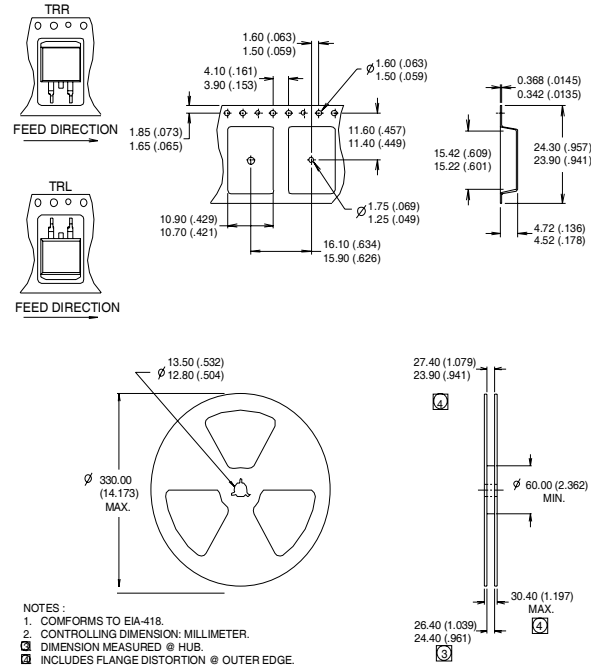

### Notes:

- ① Repetitive rating; pulse width limited by max. junction temperature. (See fig. 11).
- ② Limited by  $T_{Jmax}$ , starting  $T_J = 25^\circ\text{C}$ ,  $L = 0.12\text{mH}$ ,  $R_G = 25\Omega$ ,  $I_{AS} = 34\text{A}$ ,  $V_{GS} = 10\text{V}$ . Part not recommended for use above this value.
- ③ Pulse width  $\leq 1.0\text{ms}$ ; duty cycle  $\leq 2\%$ .
- ④  $C_{oss}$  eff. is a fixed capacitance that gives the same charging time as  $C_{oss}$  while  $V_{DS}$  is rising from 0 to 80%  $V_{DSS}$ .
- ⑤ Limited by  $T_{Jmax}$ , see Fig.12a, 12b, 15, 16 for typical repetitive avalanche performance.
- ⑥ This value determined from sample failure population. 100% tested to this value in production.
- ⑦ This is only applied to TO-220AB package.
- ⑧ This is applied to D<sup>2</sup>Pak, when mounted on 1" square PCB (FR-4 or G-10 Material). For recommended footprint and soldering techniques refer to application note #AN-994.

Data and specifications subject to change without notice.  
This product has been designed and qualified for the Industrial market.  
Qualification Standards can be found on IR's Web site.

International  
**IR** Rectifier

**IR WORLD HEADQUARTERS:** 233 Kansas St., El Segundo, California 90245, USA Tel: (310) 252-7105  
TAC Fax: (310) 252-7903

Visit us at [www.irf.com](http://www.irf.com) for sales contact information. 09/2010

[www.irf.com](http://www.irf.com)

# Mouser Electronics

Authorized Distributor

Click to View Pricing, Inventory, Delivery & Lifecycle Information:

[Infineon:](#)

[IRFZ44VZPBF](#) [IRFZ44VZSPBF](#)