

| ITEM | QTY | PART NUMBER | PART DESCRIPTION |
|------|-----|--------------|--|
| 1 | 1 | LPRX-XXX-XXX | Surface Mount Right Angle Light Pipe, 2.8mm, 4 Station. See Table on 2nd Page |
| 2 | 1 | RLPHX-XXX | LPR Housing, 4 Station, White. See Table on 2nd Page |

| REV. | DESCRIPTION | DATE | APPROVED |
|------|-------------------------------------|----------|----------|
| A | Engineering Release | 11/06/09 | T. Y. |
| B | Added Overall Height "K" Dim | 03/04/11 | T. Y. |
| C | Added Overall Snap Height Dimension | 08/15/12 | T. Y. |
| D | Added Color Options, Sheet #3 | 02/02/16 | J. C. |

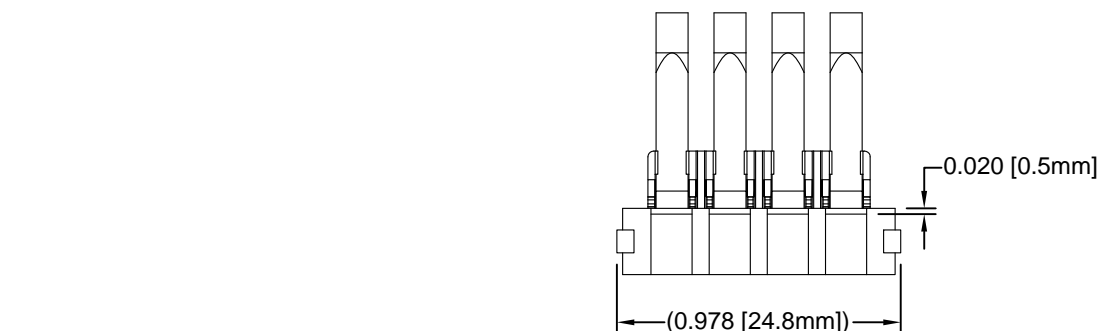

| STANDARD TOLERANCE (UNLESS OTHERWISE SPECIFIED) | | BIVAR® | |
|--|--------------------------|---|-----------------------|
| DECIMALS | ANGULAR | 4 THOMAS, IRVINE, CA. 92618 | |
| .X ± .1 | X° ± 1° | TEL: (949) 951-8808 FAX: (949) 951-3974 | |
| .XX ± .01 | | TITLE: RIGHT ANGLE LIGHT PIPE, 2.8MM, 4 STATION | |
| .XXX ± .010 | | PART NO: RLP4-XXX-XXX | REVISION: D |
| DESIGNED: Raffy Paje | DATE: 11/06/09 | CAGE CODE : 32559 | SHEET # 1 OF 3 |
| CHECKED: T. Yin | DATE: 11/06/09 | CAD GENERATED DOCUMENT. DO NOT MEASURE DRAWING. | |

| REV. | DESCRIPTION | DATE | APPROVED |
|------|--------------|------|----------|
| | SEE SHEET #1 | | |
| | | | |
| | | | |
| | | | |

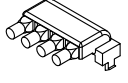
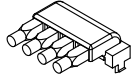
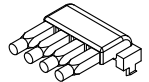
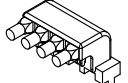
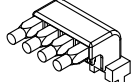
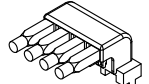
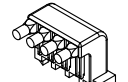
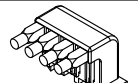
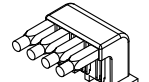
| RLP4-XXX-XXX | | | | | | |
|--------------|----------------|----------------|----------------|--------------|-----------|---|
| ASSY P/N | H | L | K | LPR4-XXX-XXX | RLPH4-XXX | FIGURE |
| RLP4-200-500 | 0.197 [5.0mm] | 0.551 [14.0mm] | 0.287 [7.3mm] | LPR4-200-500 | RLPH4-200 |  |
| RLP4-200-650 | | 0.669 [17.0mm] | | LPR4-200-650 | RLPH4-200 |  |
| RLP4-200-800 | | 0.787 [20.0mm] | | LPR4-200-800 | RLPH4-200 |  |
| RLP4-400-500 | 0.394 [10.0mm] | 0.551 [14.0mm] | 0.484 [12.3mm] | LPR4-400-500 | RLPH4-400 |  |
| RLP4-400-650 | | 0.669 [17.0mm] | | LPR4-400-650 | RLPH4-400 |  |
| RLP4-400-800 | | 0.787 [20.0mm] | | LPR4-400-800 | RPH4-400 |  |
| RLP4-600-500 | 0.591 [15.0mm] | 0.551 [14.0mm] | 0.681 [17.3mm] | LPR4-600-500 | RLPH4-600 |  |
| RLP4-600-650 | | 0.669 [17.0mm] | | LPR4-600-650 | RLPH4-600 |  |
| RLP4-600-800 | | 0.787 [20.0mm] | | LPR4-600-800 | RLPH4-600 |  |

| | |
|--|---------|
| STANDARD TOLERANCE (UNLESS OTHERWISE SPECIFIED) | |
| DECIMALS | ANGULAR |
| .X ± .1 | X° ± 1° |
| .XX ± .01 | |
| .XXX ± .010 | |

BIVAR[®]
 4 THOMAS, IRVINE, CA. 92618
 TEL: (949) 951-8808 FAX: (949) 951-3974



TITLE: RIGHT ANGLE LIGHT PIPE,
2.8MM, 4 STATION

DESIGNED:
Raffy Paje

DATE:
11/06/09

PART NO: RLP4-XXX-XXX

REVISION:
D

CHECKED:
T. Yin

DATE:
11/06/09

CAGE CODE : 32559 SHEET # 2 OF 3
 CAD GENERATED DOCUMENT. DO NOT MEASURE DRAWING.

OTHER AVAILABLE COLORS

* SEE TABLE FOR ORDERING INFORMATION

| REV. | DESCRIPTION | DATE | APPROVED |
|------|--------------|------|----------|
| | SEE SHEET #1 | | |
| | | | |
| | | | |
| | | | |

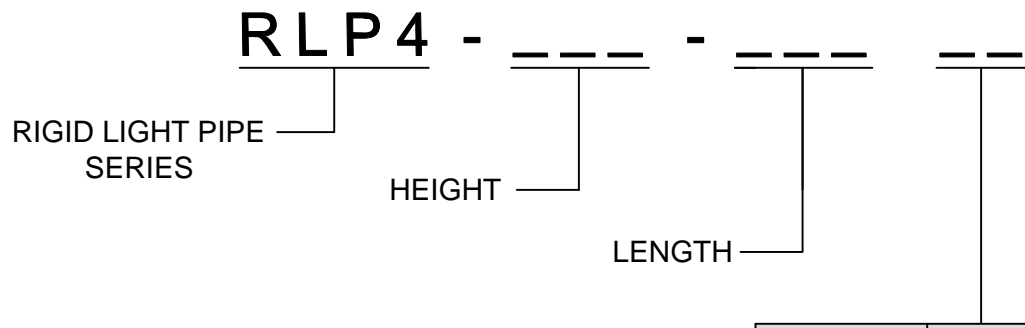

| COLOR | Order Code |
|--------|------------|
| BLUE | BE |
| BLACK | BK |
| GREEN | GN |
| GRAY | GY |
| RED | RD |
| YELLOW | YW |

NOTE: LEAVE ORDER CODE BLANK IF NO COLOR IS DESIRED.

- 2. ONLY LIGHT PIPES OF ASSEMBLIES WILL BE DYED.
- 1. PARTS ARE DYED TO COLOR UPON REQUEST.

| | | | |
|---|--------------------------|--|------------------------------|
| STANDARD TOLERANCE (UNLESS OTHERWISE SPECIFIED) DECIMALS ANGULAR | |  4 THOMAS, IRVINE, CA. 92618 TEL: (949) 951-8808 FAX: (949) 951-3974 | |
|  | | | |
| DESIGNED: K. Aukshunas | DATE: 01/25/16 | TITLE: RIGHT ANGLE LIGHT PIPE, 2.8MM, 4 STATION | |
| CHECKED: J. Chiang | DATE: 01/25/16 | PART NO: RLP4-XXX-XXX | REVISION: D |
| | | CAGE CODE : 32559 | SHEET # 3 OF 3 |
| CAD GENERATED DOCUMENT. DO NOT MEASURE DRAWING. | | | |

Mouser Electronics

Authorized Distributor

Click to View Pricing, Inventory, Delivery & Lifecycle Information:

[BIVAR:](#)

[RLP4-200-500](#) [RLP4-200-650](#) [RLP4-200-800](#) [RLP4-400-500](#) [RLP4-400-650](#) [RLP4-400-800](#) [RLP4-600-500](#) [RLP4-600-650](#) [RLP4-600-800](#)