

SJ107061

(DRAWING NO.) 図面番号

版数 REV.	年月日 DATE	DCN NO.	変更内容 DESCRIPTION	製図 DR.	担当 CHK.	査閲 APPD.	承認 APPD.
2	13/MAY/2011	072061	ADD THE LOGO OF "SPECIAL CONTROL ITEM" CHANGE VIEW SCALE	—	M. KUROIWA	—	N. Oishi

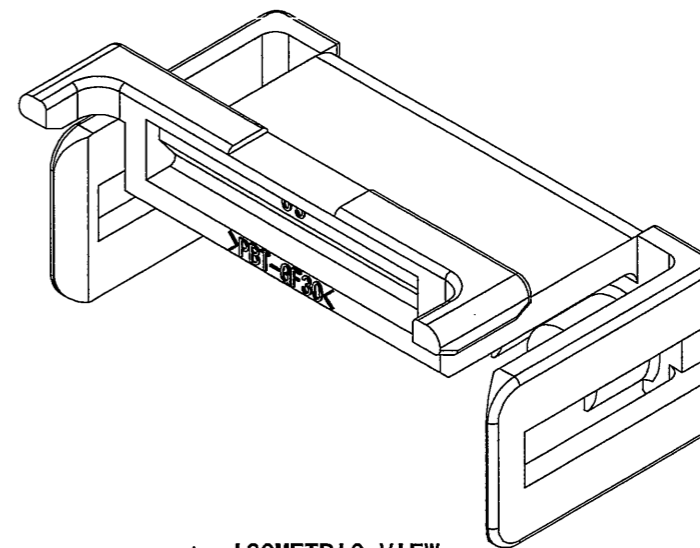
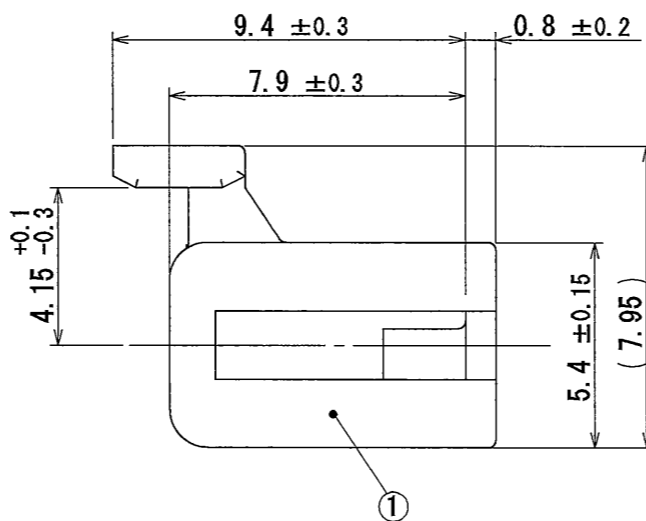
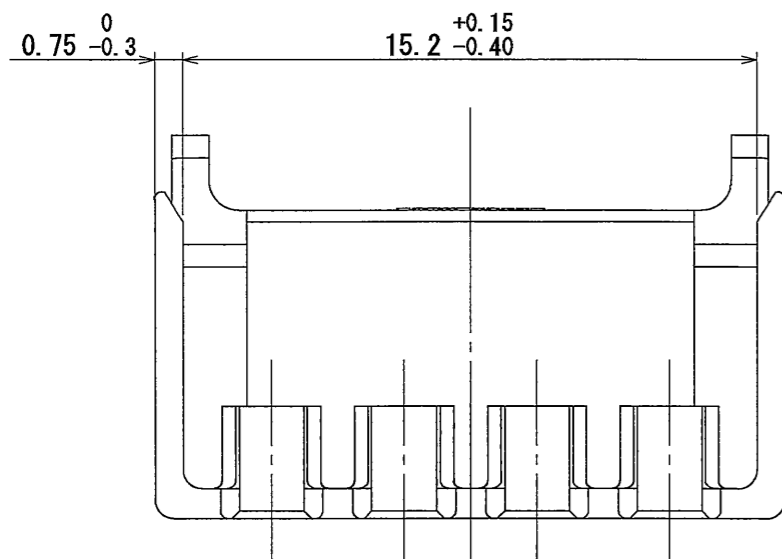
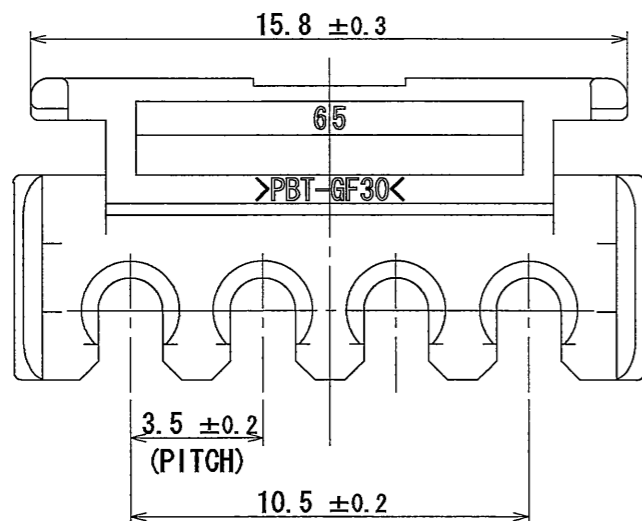
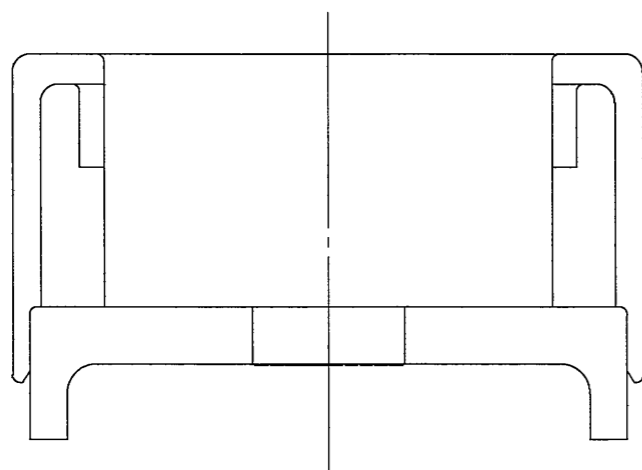

△ ISOMETRIC VIEW (REF.)

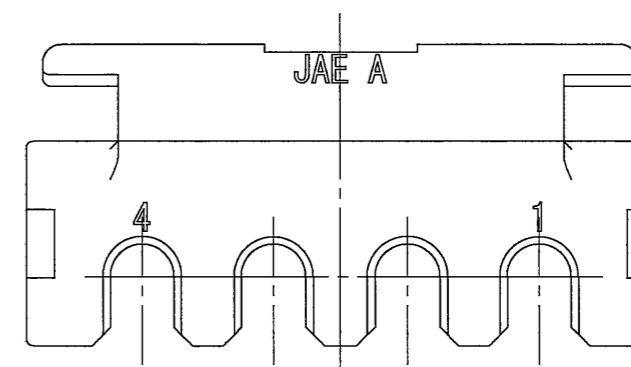

特別管理品目
SPECIAL CONTROL ITEM
MX (AUTO)

1	SOCKET RETAINER	1	30%GF PBT	—	COLOR : WHITE
符号 NO.	名称 DESCRIPTION	数量 QTY.	材料 MATERIAL	仕上 FINISH	備考 REMARKS
仕様書 (SPECIFICATION) JACS-10389		第1版 (ORIGINAL DATE) 12/JUL/2007		尺度 (SCALE) 5:1	シリーズ (SERIES) MX44
一般公差 (GENERAL TOLERANCE)		製図 DR. T. MORITA		名称 (TITLE) MX44004XR1 (MX44-4P SOCKET RETAINER)	
寸法 (DIMENSION)		担当 CHK. Y. NAKAMURA		日本航空電子工業株式会社 JAPAN AVIATION ELECTRONICS INDUSTRY, LTD.	
角度 (ANGLES)		査閲 APPD. —		図面番号 (DRAWING NO.) SJ107061	
. ± 0.8		承認 APPD. T. TOTANI		質量 (MASS)	
. × ± 0.4				JAE Connector DIV. Proprietary. Copyright (C) 2007, Japan Aviation Electronics Industry, LTD.	
. × × ± 0.1				SIZE A3	
. × × × ±				版数 (REV.) 2	

DCF-C-212F (05.08)

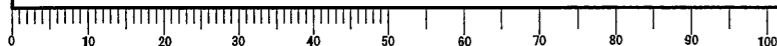

S/W

Mouser Electronics

Authorized Distributor

Click to View Pricing, Inventory, Delivery & Lifecycle Information:

[JAE Electronics:](#)

[MX44004XR1](#)