

Schottky Diodes

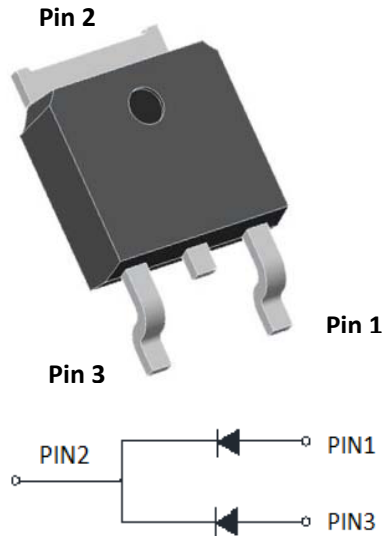

Features

- High frequency operation
- High purity, high temperature epoxy encapsulation for enhanced mechanical strength and moisture resistance
- Guard ring for enhanced ruggedness and long term reliability

Typical Applications

Typical applications are in switching power supplies, converters, freewheeling diodes, and reverse battery protection.

Mechanical Data

- **Package:** TO-252
Molding compound meets UL 94 V-0 flammability rating, RoHS-compliant
- **Terminals:** Tin plated leads, solderable per J-STD-002 and JESD22-B102
- **Polarity:** As marked

■Maximum Ratings (T_a=25°C Unless otherwise specified)

PARAMETER	SYMBOL	UNIT	MBR10100CDS	MBR10150CDS	MBR10200CDS
Device marking code			MBR10100CDS	MBR10150CDS	MBR10200CDS
Repetitive Peak Reverse Voltage	VRRM	V	100	150	200
Average Rectified Output Current @60Hz sine wave, R-load, T _a =25°C	I _O	A	10		
Surge(Non-repetitive)Forward Current @60Hz half sine-wave, 1 cycle, T _a =25°C	I _{FSM}	A	100		
Current Squared Time @1ms≤t<8.3ms T _J =25°C,	I ² t	A ² s	41		
Storage Temperature	T _{stg}	°C	-55 ~ +175		
Junction Temperature	T _j	°C	-55 ~ +175		

■Electrical Characteristics (T_a=25°C Unless otherwise specified)

PARAMETER	SYMBOL	UNIT	TEST CONDITIONS	MBR10100CDS	MBR10150CDS	MBR10200CDS
Maximum instantaneous forward voltage drop per diode	V _{FM}	V	I _{FM} =5.0A	0.83	0.88	0.93
Maximum DC reverse current at rated DC blocking voltage per diode	I _{RRM1}	mA	V _{RM} =V _{RRM} T _a =25°C	0.1		
	I _{RRM2}		V _{RM} =V _{RRM} T _a =125°C	20		

■Thermal Characteristics (T_a=25°C Unless otherwise specified)

PARAMETER	SYMBOL	UNIT	MBR10100CDS	MBR10150CDS	MBR10200CDS
Thermal Resistance Between junction and case	R _{θj-c}	°C/W	5.0		

■Ordering Information (Example)

PREFERRED P/N	UNIT WEIGHT(g)	MINIMUM PACKAGE(pcs)	INNER BOX QUANTITY(pcs)	OUTER CARTON QUANTITY(pcs)	DELIVERY MODE
MBR10100CDS THRU MBR10200CDS	Approximate 0.32	2500	2500	25000	Reel



MBR10100CDS THRU MBR10200CDS

■ Characteristics (Typical)

FIG1: I_o -T_c Curve

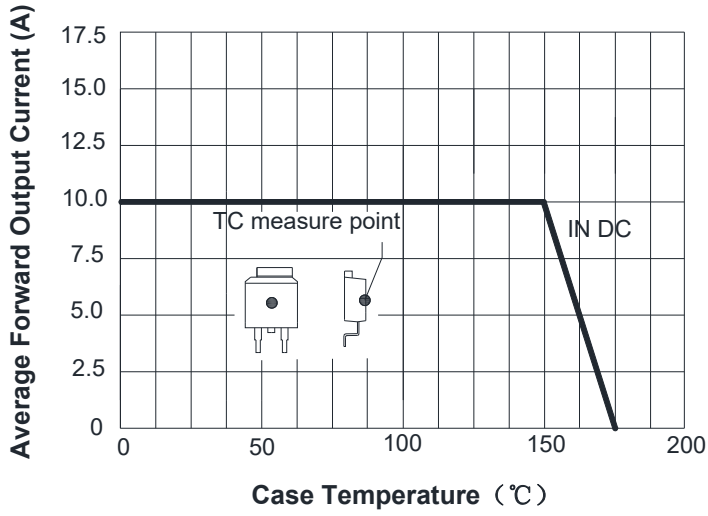

FIG2: Surge Forward Current Capability

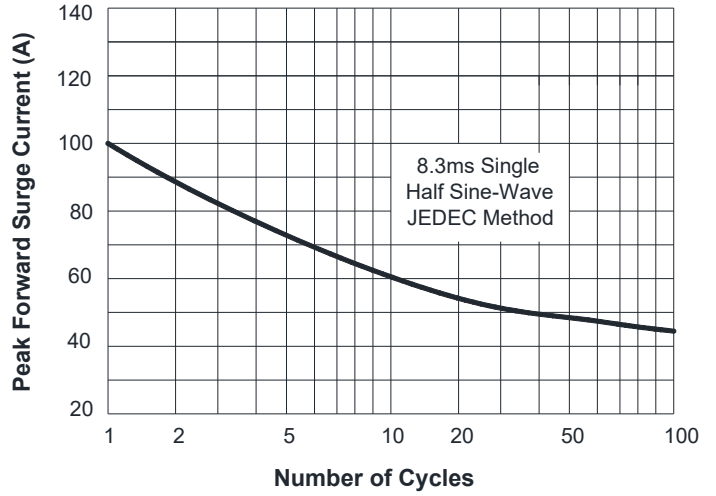

FIG3: Forward Voltage

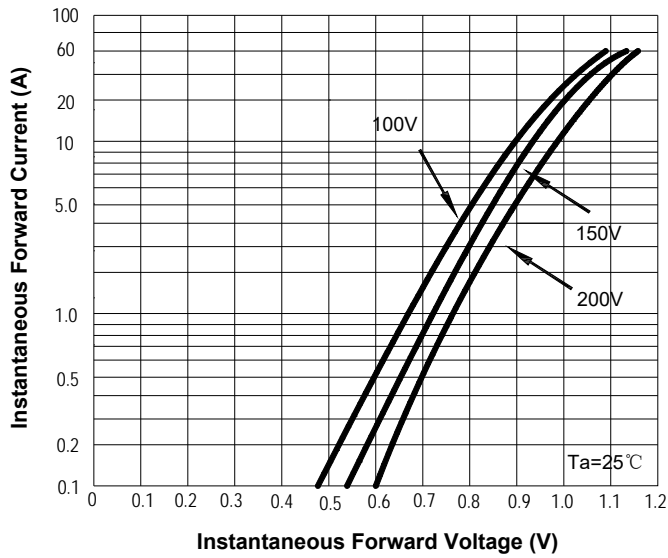
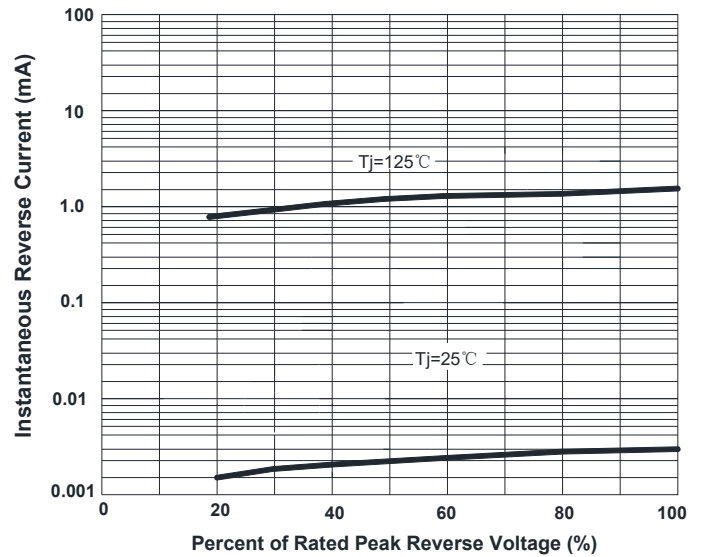

FIG4: Instantaneous Reverse Characteristics





MBR10100CDS THRU MBR10200CDS

■ Outline Dimensions

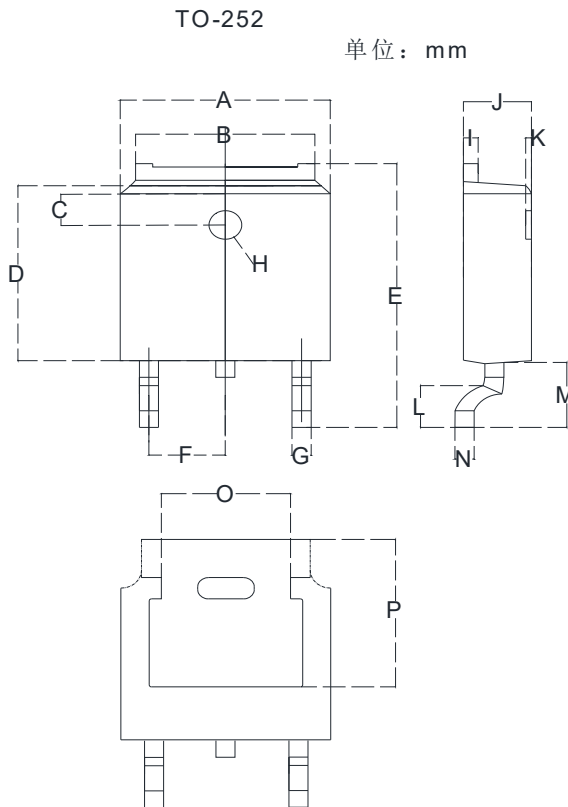

TO-252		
Dim	Min	Max
A	6.500	6.700
B	5.100	5.460
C	1.400	1.800
D	6.000	6.200
E	10.000	10.400
F	2.166	2.366
G	0.660	0.860
H	Φ 1.050	Φ 1.350
I	0.460	0.580
J	2.200	2.400
K	0	0.300
L	0.890	2.290
M	2.730	3.080
N	0.430	0.580
O	4.2	4.95
P	5.15	5.45

■ Suggested Pad Layout

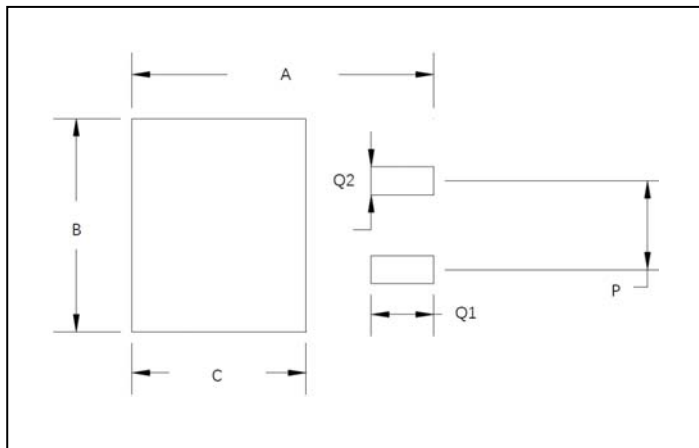

Dim	Millimeters
A	11.4
B	6.74
C	6.23
P	4.56
Q1	2.28
Q2	1.52



MBR10100CDS THRU MBR10200CDS

Disclaimer

The information presented in this document is for reference only. Yangzhou Yangjie Electronic Technology Co., Ltd. reserves the right to make changes without notice for the specification of the products displayed herein to improve reliability, function or design or otherwise.

The product listed herein is designed to be used with ordinary electronic equipment or devices, and not designed to be used with equipment or devices which require high level of reliability and the malfunction of which would directly endanger human life (such as medical instruments, transportation equipment, aerospace machinery, nuclear-reactor controllers, fuel controllers and other safety devices), Yangjie or anyone on its behalf, assumes no responsibility or liability for any damages resulting from such improper use of sale.

This publication supersedes & replaces all information previously supplied. For additional information, please visit our website [http:// www.21yangjie.com](http://www.21yangjie.com) , or consult your nearest Yangjie's sales office for further assistance.