

Datasheet

ENGLISH

RS PRO, 12 V dc, 20000 gcm, Brushed DC Geared Motor, Output Speed 67 rpm

Stock No: 420-621



Specifications:

Output Speed	67 rpm
Supply Voltage	12 V dc
Maximum Output Torque	20000 g.cm
DC Motor Type	Brushed
Shaft Diameter	8mm
Power Rating	41.3 W
Gearhead Type	Planetary
Length	111.9mm
Width	44.6mm
Current Rating	5.5 A
Weight	624g

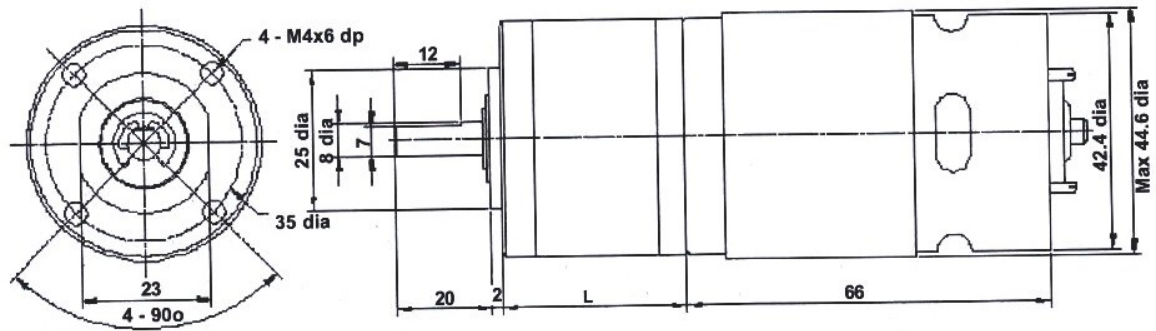

Operating relative humidity 20% ~ 85%
 Operating temperature range -10°C ~ +60°C

Ratio	L
104:1	45.9mm

Gearbox Housing material	Metal
Backlash at no-load	< 3°
Bearing at output	Sleeve bearings
Radial load (10mm from flange)	< 5 kgf
Shaft axial load	< 3 kgf
Shaft press fit force max	< 15 kgf
Radial play of shaft	< 0.8mm
Thrust play of shaft	< 0.3mm

Reduction Ratio	Rated tolerance Torque	Max momentary Tolerance Torque	Efficiency
1/104	20.0 kgf-cm Max.	60.0 kgf-cm	60%

Reduction Table RPM SUPPLY VOLTAGE	6v	8v	12v
420-621	34	50	67

Note: Motor speeds may vary by (+) or (-) 12.5%