

THIS DOCUMENT IS THE PROPERTY OF
KEYSTONE ELECTRONICS CORP. AND
SHALL NOT BE REPRODUCED, DISTRIBUTED
OR USED AS A BASIS FOR MANUFACTURE
WITHOUT PRIOR WRITTEN PERMISSION
FROM KEYSTONE ELECTRONICS CORP.

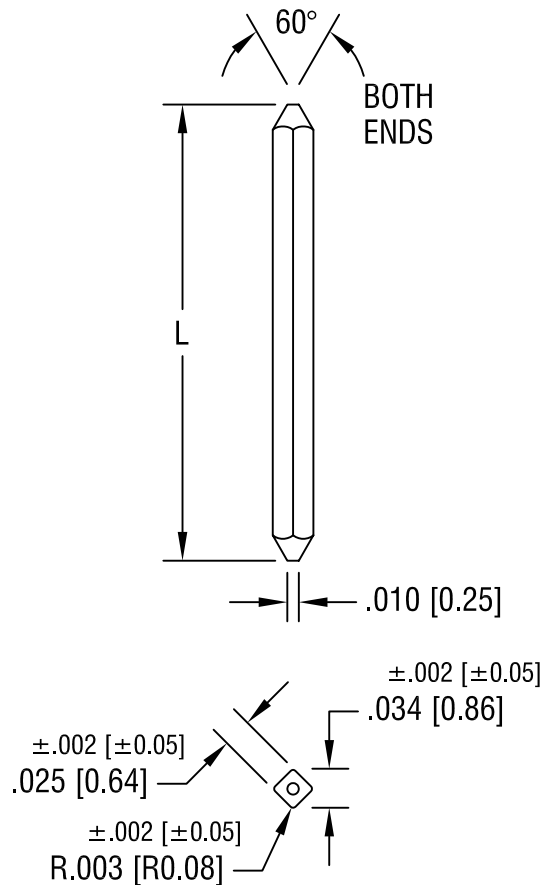

PART NO.	'L' DIM.
5070	.400 [10.16]
5071	.440 [11.17]
5072	.515 [13.08]
5073	.535 [13.59]
5074	.600 [15.24]
5075	.615 [15.62]
5076	.625 [15.88]
5077	.642 [16.31]
5078	.675 [17.14]
5079	.720 [18.29]
5080	.850 [21.59]
5081	.916 [23.27]
5082	.995 [25.27]
5083	1.130 [28.70]

KEYSTONE ELECTRONICS CORP.

ASTORIA, N.Y. 11105-2017

PART NAME				WIRE WRAP PIN			
MATERIAL				PHOSPHOR BRONZE			
FINISH		DRN BY		DATE			
TIN PLATE		BOONE		2.27.06			
		APP'D		SCALE			
		LN		6X			
TOLERANCES		INCH [MM]		CODE		DWG NO.	
DECIMAL		± .005 [± 0.15]		C/M		5070-5083	
ANGULAR		± 1°		UNLESS OTHERWISE SPECIFIED			

DATE	DESCRIPTION	REV.

Mouser Electronics

Authorized Distributor

Click to View Pricing, Inventory, Delivery & Lifecycle Information:

[Keystone Electronics:](#)

[5081](#)