

THIS DRAWING IS UNPUBLISHED. RELEASED FOR PUBLICATION 20
 © COPYRIGHT 20 BY - ALL RIGHTS RESERVED.

LOC	DIST	REVISIONS					
GP	00	P	LTR	DESCRIPTION	DATE	DWN	APVD
			BI	REVISED PER ECO-11-004835	11MAR2011	RK	HMR

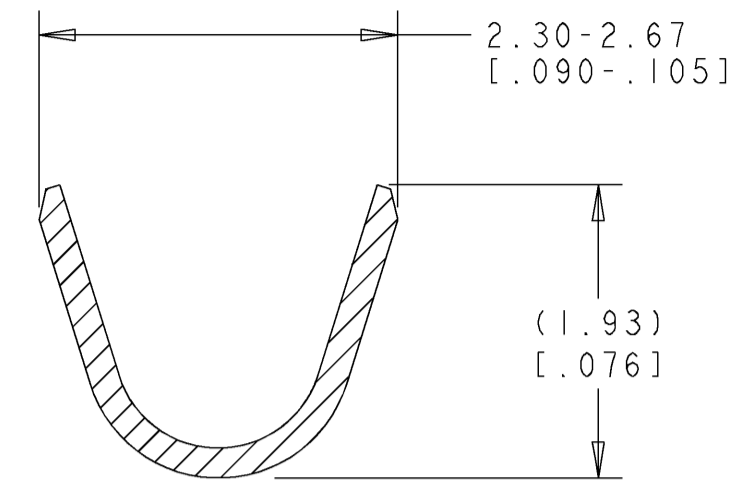

SECTION A-A
SCALE 20:1

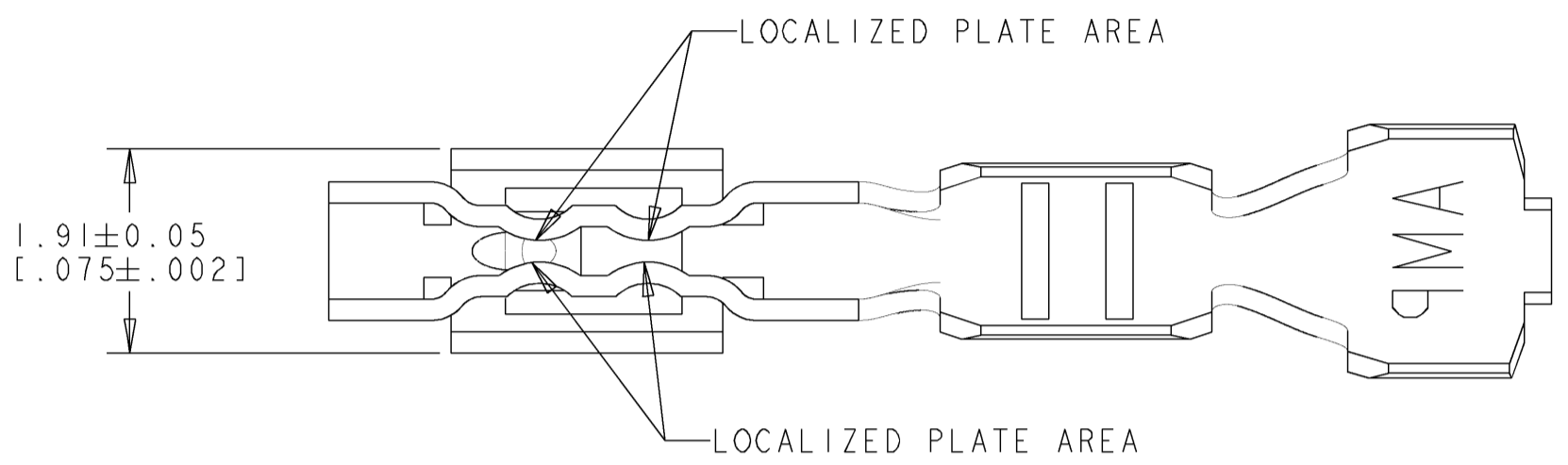

1. WIRE RANGE .13 - .35 mm² (26 -22 AWG).
2. INSULATION RANGE 0.89 - 1.65 [.035 - .065].
3. 0.00038 [.000015] MIN GOLD STRIPE IN LOCALIZED AREA OVER 0.00127 [.000050] MIN NICKEL OVER ENTIRE CONTACT -OR- GOLD FLASH OVER PALLADIUM-NICKEL .00038 [.000015] MIN TOTAL IN LOCALIZED AREA OVER .00127 [.000050] MIN NICKEL OVER ENTIRE CONTACT.
4. 0.00076 [.000030] MIN GOLD STRIPE IN LOCALIZED AREA OVER 0.000127 [.000050] MIN NICKEL OVER ENTIRE CONTACT. -OR- GOLD FLASH OVER PALLADIUM-NICKEL .00076 [.000030] MIN TOTAL IN LOCALIZED AREA OVER .00127 [.000050] MIN NICKEL OVER ENTIRE CONTACT.
5. NOT FOR USE IN HOUSING PART NUMBER 770602.
6. CONTACTS COATED WITH ANTI-FRETTING LUBRICANT.

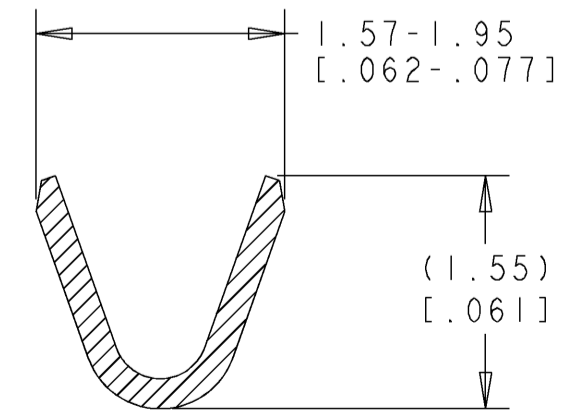
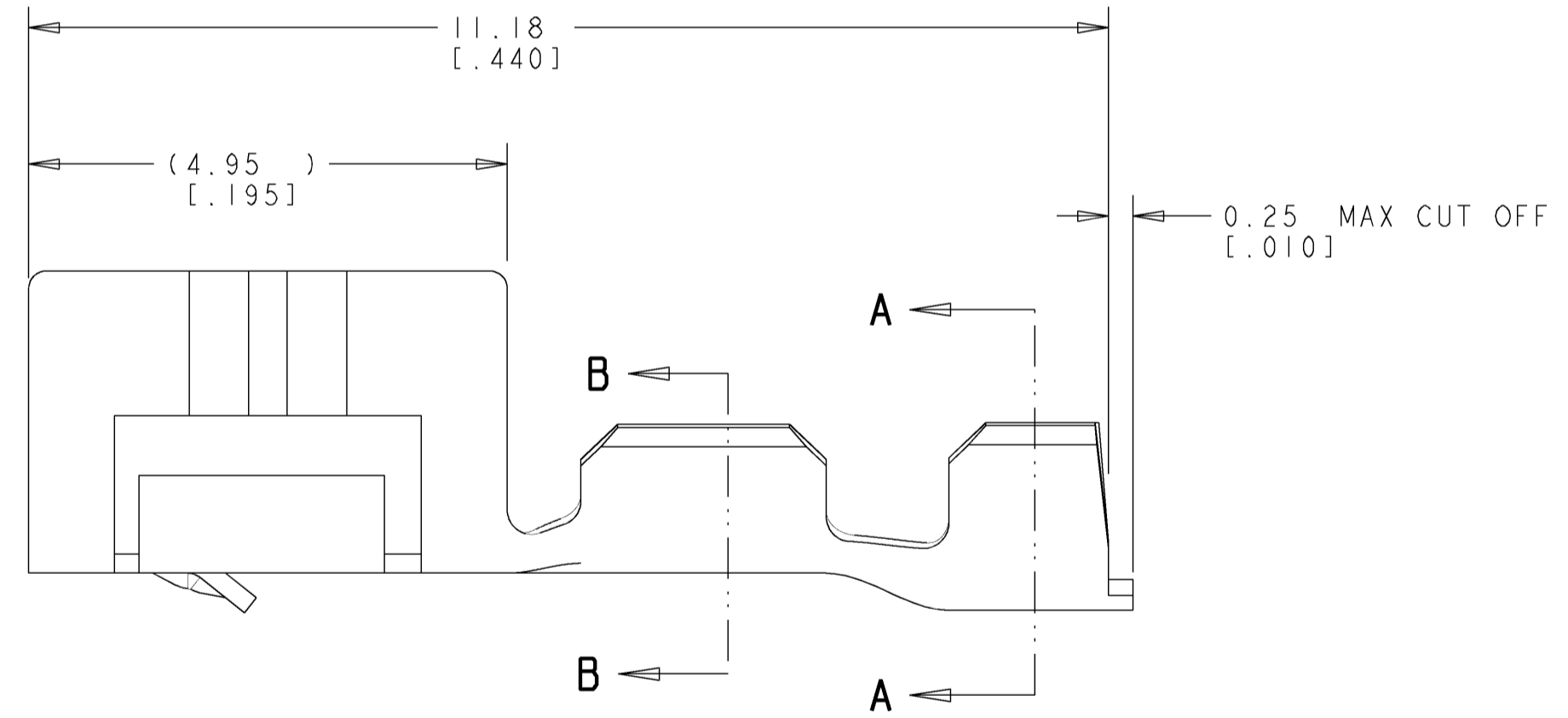

SECTION B-B
SCALE 20:1

4	PH BRZ	1445336-3
3	PH BRZ	1445336-2
PRE-TIN	PH BRZ	1445336-1
FINISH	MATERIAL	PART NUMBER



THIS DRAWING IS A CONTROLLED DOCUMENT.

DIMENSIONS: mm [INCHES]	TOLERANCES UNLESS OTHERWISE SPECIFIED: 0 PLC ± 1 PLC ± 2 PLC ±0.13 [.005] 3 PLC ± 4 PLC ± ANGLES ± FINISH	DWN: 21-JUNE-2001 K. WHITAKER CHK: 21-JUNE-2001 J. ELLIS APVD: 21-JUNE-2001 J. ELLIS	NAME: CONTACT, LOOSE PIECE, CST 100 11
MATERIAL: SEE TABLE	SEE TABLE	PRODUCT SPEC: 108-1948 APPLICATION SPEC: 114-13036 WEIGHT: -	SIZE: A2 CAGE CODE: 00779 DRAWING NO: 1445336 RESTRICTED TO: -
CUSTOMER DRAWING		SCALE: 15:1	SHEET 1 OF 1 REV: BI

STE TE Connectivity

Mouser Electronics

Authorized Distributor

Click to View Pricing, Inventory, Delivery & Lifecycle Information:

[TE Connectivity:](#)

[1445336-2](#)