

DIN 41612 / IEC 60603-2 Female Connectors New Design

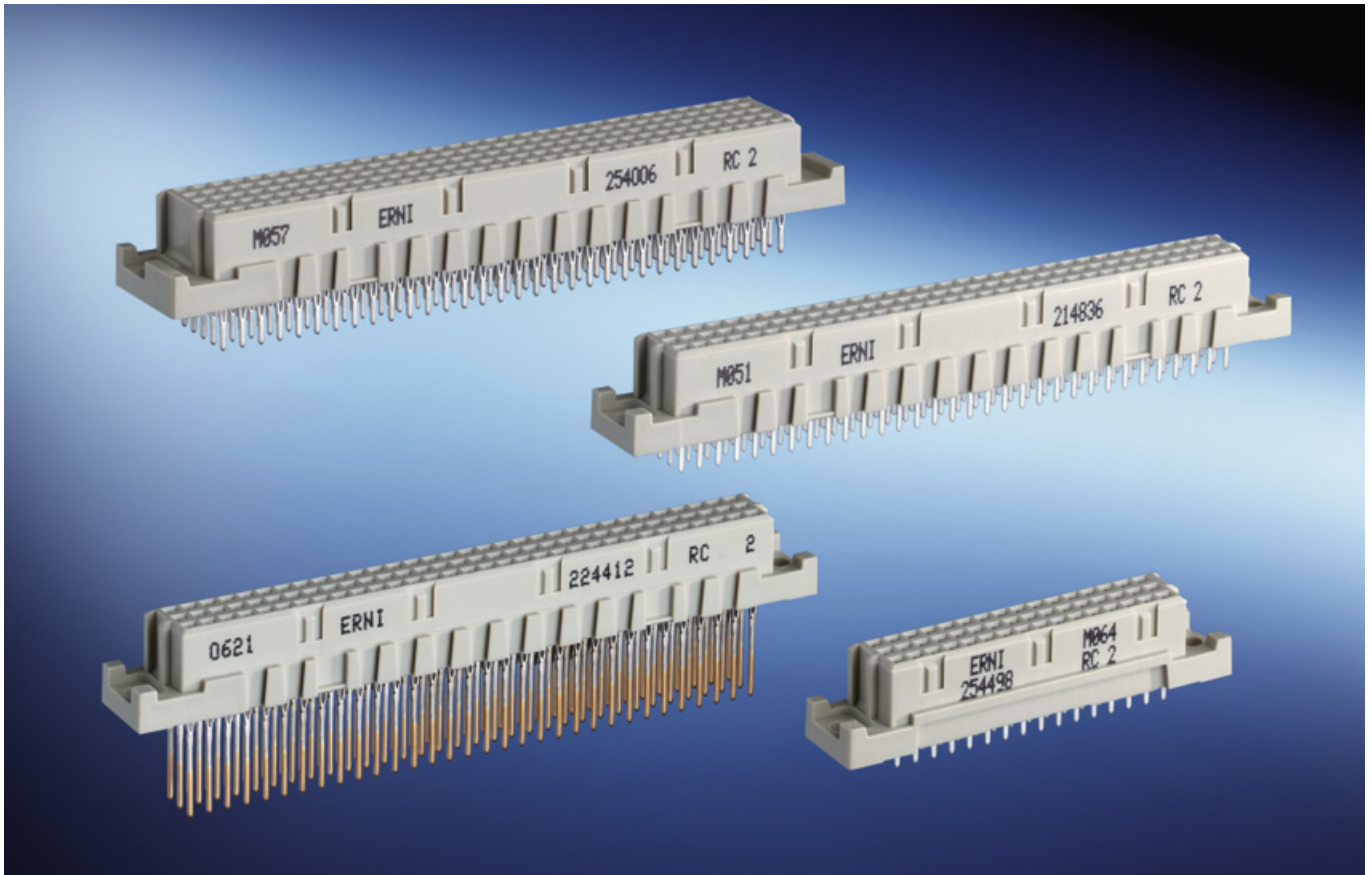

ERNI introduces a new design of its female DIN connectors. The new design offers the following advantages:

- Reduction of press-in force by approx. 25%, using the new „Eye of the Needle“ pressfit zone. This leads to lesser strain towards the PCB.
- 100% controlled quality of the pins due to consequent usage of Automated Optical Inspection during the manufacturing process.
- Partial and mixed loading possible.
Available termination lengths:
Solder: 2.5 mm; 3.7 mm; 4.0 mm; 13.0 mm; 17.0 mm
Pressfit: 2.9 mm; 4.0 mm; 5.5 mm; 13.0 mm w. Transfer Zone; 17.0 mm w. Transfer Zone
Wire Wrap: 13.0 mm; 17.0 mm
- Dimensions of insulation bodies remain unchanged for backwards compatibility.
- Fixation clip or retaining loop for efficient mounting of the connector when soldering is selectable in all positions.
- Solder stop versions, preventing a rising of the solder up into the housing, available on request for type B and C connectors.
- Transfer zone contacts are selectable for all versions.
- A simple coding mechanism, by using coding strips, is standard on all type B, C, E and CD connectors.
- The THR versions are made of a high temperature resistant material which makes them suitable for reflow soldering.

With immediate effect the following parts will be converted:

Vertical Female Connectors Type C

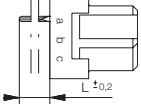
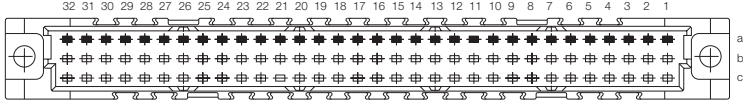
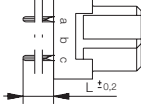
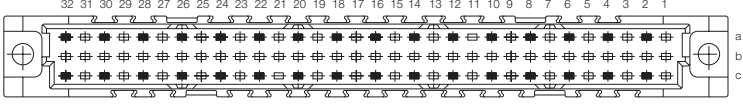
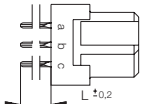
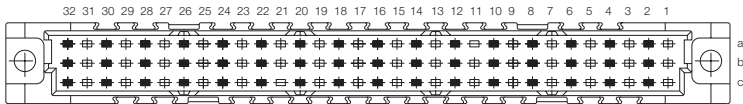
| Number of Pins | Termination | Termination Length | Class | Pin Dimensions | Part Number Old Design | Part Number New Design |
|---|-------------------------|--|-------|----------------|------------------------|------------------------|
|  | |  | | | | |
| 32 | Solder | 13 mm | 2 | 0.6 x 0.6 mm | 543404 | 244296 |
|  | |  | | | | |
| 32 | Solder | 4 mm | 2 | 0.65 x 0.3 mm | 043017* | 244265 |
| 32 | Solder | 4 mm | 2 | 0.65 x 0.3 mm | 004767 | 244265 |
| 32 | Solder with Clip | 4 mm | 2 | 0.65 x 0.3 mm | 033297 | 234431 |
| 32 | Solder | 13 mm | 2 | 0.6 x 0.6 mm | 543403 | 244297 |
| 32 | Solder w. Transfer Zone | 13 mm | 2 | 0.6 x 0.6 mm | 023337 | 244298 |
| 32 | Solder w. Transfer Zone | 17 mm | 2 | 0.6 x 0.6 mm | 593404 | 244299 |
|  | |  | | | | |
| 48 | Solder | 2.5 mm | 2 | 0.65 x 0.3 mm | 123324 | 224409 |
| 48 | Solder with Clip | 4 mm | 2 | 0.65 x 0.3 mm | 123786 | 234432 |
| 48 | Solder | 4 mm | 2 | 0.65 x 0.3 mm | 033628 | 284082 |

* Termination Length: 3.7 mm

** Termination Length: 4.5 mm

*** Termination Length: 2.9 mm

Vertical Female Connectors Type C

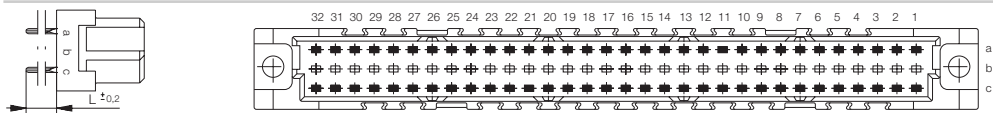
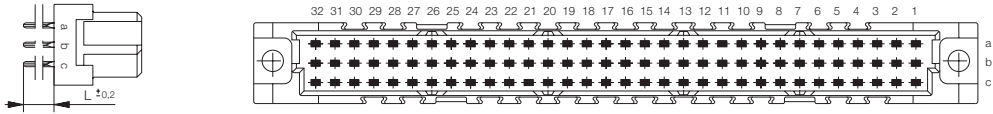
| Number of Pins | Termination | Termination Length | Class | Pin Dimensions | Part Number Old Design | Part Number New Design |
|--|-------------------------|--------------------|-------|----------------|------------------------|------------------------|
|  | | | | | | |
| 64 | Solder w. kinked Legs | 2.5 mm | 2 | 0.65 x 0.3 mm | 063543 | 284170 |
| 64 | Solder | 4 mm | 2 | 0.65 x 0.3 mm | 594834 | 224411 |
| 64 | Solder | 4 mm | 2 | 0.65 x 0.3 mm | 543407 | 224411 |
| 64 | Solder | 4 mm | 2 | 0.65 x 0.3 mm | 064188** | 224411 |
| 64 | Solder with Clip | 4 mm | 2 | 0.65 x 0.3 mm | 063727** | 224471 |
| 64 | Solder w/o Flange | 4 mm | 2 | 0.65 x 0.3 mm | - | 223799 |
| 64 | Solder | 13 mm | 2 | 0.6 x 0.6 mm | 543401 | 244301 |
| 64 | Solder w. Transfer Zone | 13 mm | 2 | 0.6 x 0.6 mm | 013962 | 244302 |
| 64 | Solder | 17 mm | 2 | 0.6 x 0.6 mm | 593405 | 244303 |
|  | | | | | | |
| 96 | Solder | 2.5 mm | 2 | 0.65 x 0.3 mm | 063647*** | 224470 |
| 96 | Solder | 4 mm | 2 | 0.65 x 0.3 mm | 023661* | 214836 |
| 96 | Solder | 4 mm | 2 | 0.65 x 0.3 mm | 054350** | 214836 |
| 96 | Solder | 4 mm | 1 | 0.65 x 0.3 mm | 594073 | 254897 |
| 96 | Solder | 4 mm | 2 | 0.65 x 0.3 mm | 594833 | 234496 |
| 96 | Solder with Clip | 4 mm | 2 | 0.65 x 0.3 mm | 033228 | 224472 |
| 96 | Solder | 13 mm | 2 | 0.6 x 0.6 mm | 543402 | 244304 |
| 96 | Solder w. Transfer Zone | 13 mm | 2 | 0.6 x 0.6 mm | 013905 | 244305 |
| 96 | Solder w. Transfer Zone | 17 mm | 2 | 0.6 x 0.6 mm | 593406 | 244307 |
| 96 | Solder w. Transfer Zone | 17 mm | 1 | 0.6 x 0.6 mm | 593443 | 254931 |

* Termination Length: 3.7 mm

** Termination Length: 4.5 mm

*** Termination Length: 2.9 mm

Vertical Female Connectors Type C

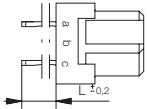
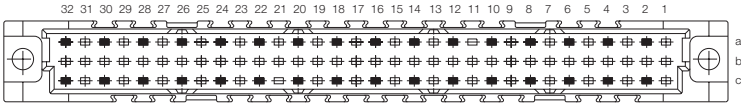
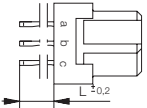
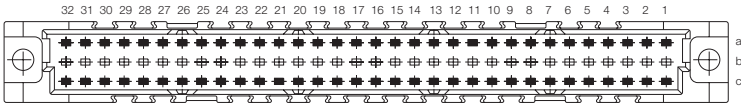
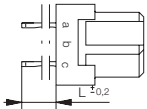
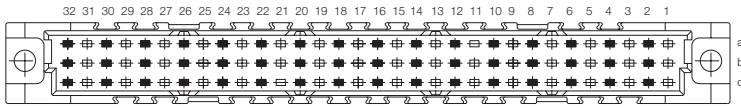
| Number of Pins | Termination | Termination Length | Class | Pin Dimensions | Part Number Old Design | Part Number New Design |
|---|--|--------------------|-------|----------------|------------------------|------------------------|
|  |  | 5.5 mm | 1 | 0.6 x 0.6 mm | 023348 | 254134 |
| | | 5.5 mm | 2 | 0.6 x 0.6 mm | 043135 | 254135 |
|  |  | 5.5 mm | 2 | 0.6 x 0.6 mm | 043124 | 254136 |
| | | 5.5 mm | 2 | 0.6 x 0.6 mm | 424999 | 254136 |
|  |  | 4 mm | 2 | 0.65 x 0.3 mm | 053149* | 244268 |
| | | 4 mm | 2 | 0.65 x 0.3 mm | 063232** | 244268 |
| | | 5.5 mm | 2 | 0.6 x 0.6 mm | 913133 | 254137 |
| | | 5.5 mm | 2 | 0.6 x 0.6 mm | 414273 | 254137 |
| | | 5.5 mm | 2 | 0.6 x 0.6 mm | 913660 | 254851 |
| | | 13 mm | 2 | 0.6 x 0.6 mm | 023397 | 244126 |
| | | 17 mm | 2 | 0.6 x 0.6 mm | 913134 | 224410 |
| | | 17 mm | 2 | 0.6 x 0.6 mm | 593272 | 244410 |

* Termination Length: 3.7 mm

** Termination Length: 4.5 mm

*** Termination Length: 2.9 mm

Vertical Female Connectors Type C

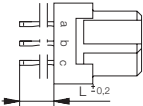
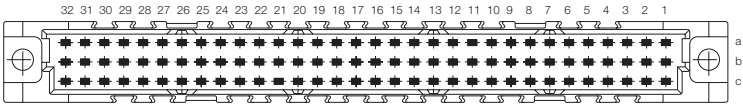
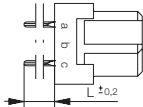
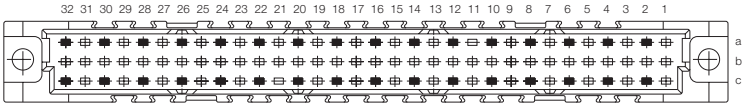
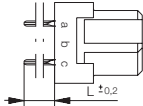
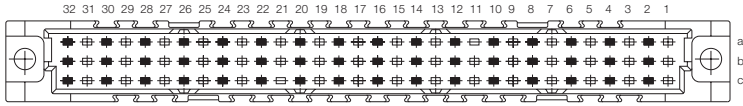
| Number of Pins | Termination | Termination Length | Class | Pin Dimensions | Part Number Old Design | Part Number New Design |
|---|---------------------------|--|-------|----------------|------------------------|------------------------|
|  | |  | | | | |
| 96 | Pressfit | 2.9 mm | 2 | 0.65 x 0.3 mm | 063512 | 254117 |
| 96 | Pressfit | 4 mm | 2 | 0.65 x 0.3 mm | 053595** | 204752 |
| 96 | Pressfit | 5.5 mm | 1 | 0.6 x 0.6 mm | 013159 | 254015 |
| 96 | Pressfit | 5.5 mm | 1 | 0.6 x 0.6 mm | 004365 | 254015 |
| 96 | Pressfit w/o Flange | 5.5 mm | 1 | 0.6 x 0.6 mm | 103691 | 254849 |
| 96 | Pressfit w/o Flange | 5.5 mm | 2 | 0.6 x 0.6 mm | 033109 | 254850 |
| 96 | Pressfit | 5.5 mm | 2 | 0.6 x 0.6 mm | 913110 | 224408 |
| 96 | Pressfit | 5.5 mm | 2 | 0.6 x 0.6 mm | 414437 | 224408 |
| 96 | Pressfit w. Transfer Zone | 13 mm | 2 | 0.6 x 0.6 mm | 063570 | 224412 |
| 96 | Pressfit w. Transfer Zone | 13 mm | 2 | 0.6 x 0.6 mm | 013964 | 224412 |
| 96 | Pressfit w. Transfer Zone | 13 mm | 1 | 0.6 x 0.6 mm | 013808 | 284135 |
| 96 | Pressfit w. Transfer Zone | 17 mm | 1 | 0.6 x 0.6 mm | 593274 | 254931 |
| 96 | Pressfit w. Transfer Zone | 17 mm | 1 | 0.6 x 0.6 mm | 023387 | 254931 |
| 96 | Pressfit w. Transfer Zone | 17 mm | 2 | 0.6 x 0.6 mm | 913135 | 244295 |
|  | |  | | | | |
| 32 | THR | 2.5 mm | 2 | 0.6 x 0.6 mm | - | 224477 |
|  | |  | | | | |
| 64 | THR | 2.5 mm | 2 | 0.6 x 0.6 mm | 164945*** | 224475 |
| 64 | THR w/o Flange | 4 mm | 2 | 0.6 x 0.6 mm | - | 223801 |

* Termination Length: 3.7 mm

** Termination Length: 4.5 mm

*** Termination Length: 2.9 mm

Vertical Female Connectors Type C

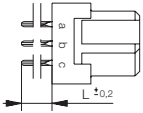
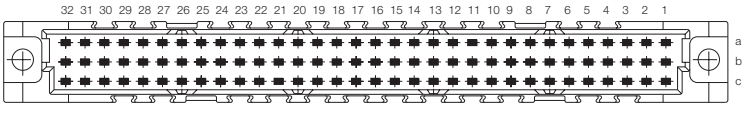
| Number of Pins | Termination | Termination Length | Class | Pin Dimensions | Part Number Old Design | Part Number New Design |
|---|-------------|--|-------|----------------|------------------------|------------------------|
|  | |  | | | | |
| 96 | THR | 2.5 mm | 1 | 0.6 x 0.6 mm | 144743*** | 224473 |

Vertical Female Connectors Type C/2

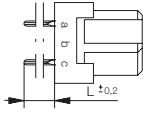
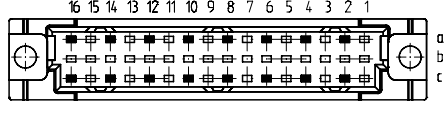
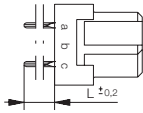
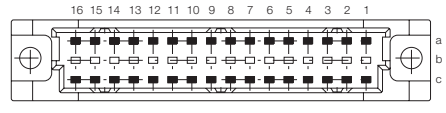
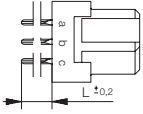
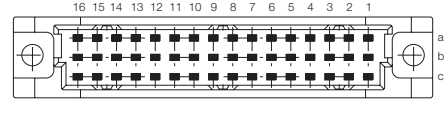







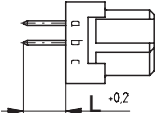
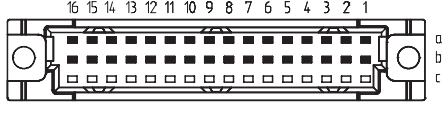
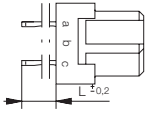
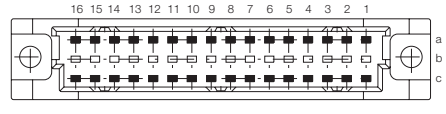
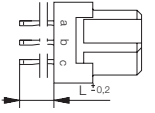
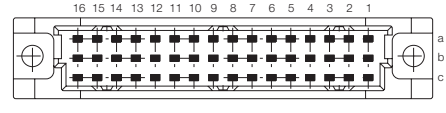

| Number of Pins | Termination | Termination Length | Class | Pin Dimensions | Part Number Old Design | Part Number New Design |
|---|-------------------|---|-------|----------------|------------------------|------------------------|
|  | |  | | | | |
| 16 | Solder | 4 mm | 2 | 0.65 x 0.3 mm | 033633 | 254892 |
|  | |  | | | | |
| 32 | Solder | 2.5 mm | 2 | 0.65 x 0.3 mm | 004816 | 254893 |
| 32 | Solder | 4 mm | 2 | 0.65 x 0.3 mm | 594086 | 284171 |
|  | |  | | | | |
| 48 | Solder | 2.5 mm | 2 | 0.65 x 0.3 mm | 003442 | 254498 |
| 48 | Solder | 4 mm | 2 | 0.65 x 0.3 mm | 913620* | 284174 |
| 48 | Solder w/o Flange | 4 mm | 2 | 0.65 x 0.3 mm | 943224* | 284175 |
| 48 | Solder | 4 mm | 1 | 0.65 x 0.3 mm | 594082 | 254895 |
| 48 | Solder | 13 mm | 2 | 0.6 x 0.6 mm | 413957 | 284172 |

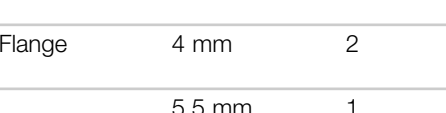
* Termination Length: 3.7 mm

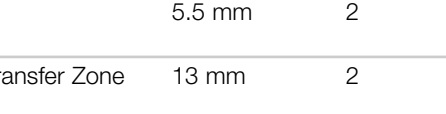
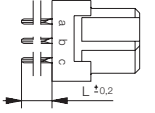
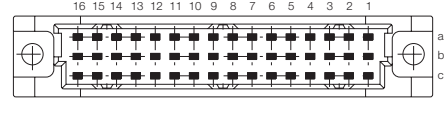
** Termination Length: 4.5 mm

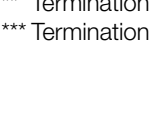
*** Termination Length: 2.9 mm

Vertical Female Connectors Type C/2











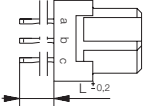
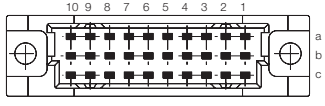

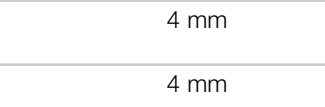
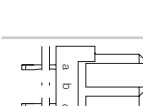
| Number of Pins | Termination | Termination Length | Class | Pin Dimensions | Part Number Old Design | Part Number New Design |
|---|---|--------------------|-------|----------------|------------------------|------------------------|
|  |  | 5.5 mm | 2 | 0.6 x 0.6 mm | 123310 | 254855 |
| 32 | Pressfit | 5.5 mm | 2 | 0.6 x 0.6 mm | | |
|  |  | 5.5 mm | 2 | 0.6 x 0.6 mm | 913654 | 254854 |
| 32 | Pressfit | 5.5 mm | 2 | 0.6 x 0.6 mm | | |
|  |  | 2.9 mm | 2 | 0.65 x 0.3 mm | - | 254926 |
| 48 | Pressfit | 2.9 mm | 2 | 0.65 x 0.3 mm | | |
|  |  | 4 mm | 2 | 0.65 x 0.3 mm | 043566* | 254887 |
| 48 | Pressfit | 4 mm | 2 | 0.65 x 0.3 mm | | |
|  |  | 4 mm | 2 | 0.65 x 0.3 mm | 053788* | 254894 |
| 48 | Pressfit w/o Flange | 4 mm | 2 | 0.65 x 0.3 mm | | |
|  |  | 5.5 mm | 1 | 0.6 x 0.6 mm | 123094 | 254852 |
| 48 | Pressfit | 5.5 mm | 1 | 0.6 x 0.6 mm | | |
|  |  | 5.5 mm | 1 | 0.6 x 0.6 mm | 414369 | 254852 |
| 48 | Pressfit | 5.5 mm | 1 | 0.6 x 0.6 mm | | |
|  |  | 5.5 mm | 2 | 0.6 x 0.6 mm | 023761 | 234647 |
| 48 | Pressfit | 5.5 mm | 2 | 0.6 x 0.6 mm | | |
|  |  | 13 mm | 2 | 0.6 x 0.6 mm | 043499 | 284136 |
| 48 | Pressfit w. Transfer Zone | 13 mm | 2 | 0.6 x 0.6 mm | | |
| | | 17 mm | 2 | 0.6 x 0.6 mm | 033547 | 254896 |
| 48 | Pressfit w. Transfer Zone | 17 mm | 2 | 0.6 x 0.6 mm | | |
| | | 2.5 mm | 2 | 0.6 x 0.6 mm | 144711 | 254970 |
| 48 | THR with Clip | 2.5 mm | 2 | 0.6 x 0.6 mm | | |

* Termination Length: 3.7 mm

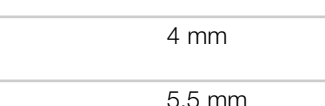
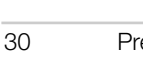
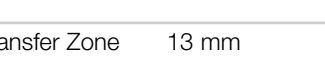
** Termination Length: 4.5 mm

*** Termination Length: 2.9 mm

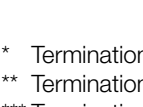
Vertical Female Connectors Type C/3







| Number of Pins | Termination | Termination Length | Class | Pin Dimensions | Part Number Old Design | Part Number New Design |
|---|---------------------------|--------------------|-------|----------------|------------------------|------------------------|
|   | Solder | 2.5 mm | 2 | 0.65 x 0.3 mm | 004791 | 244336 |
|   | Solder | 4 mm | 2 | 0.65 x 0.3 mm | 004492 | 254320 |
|   | Solder | 4 mm | 1 | 0.65 x 0.3 mm | 004491 | 254891 |
|   | Solder | 13 mm | 2 | 0.6 x 0.6 mm | 424186 | 284173 |
|   | Pressfit | 5.5 mm | 2 | 0.6 x 0.6 mm | 043592 | 254838 |
|   | Pressfit | 4 mm | 2 | 0.65 x 0.3 mm | 063310* | 254995 |
|   | Pressfit | 5.5 mm | 2 | 0.6 x 0.6 mm | 033120 | 254836 |
|   | Pressfit w/o Flange | 5.5 mm | 2 | 0.6 x 0.6 mm | 043131 | 254321 |
|   | Pressfit w. Transfer Zone | 13 mm | 2 | 0.6 x 0.6 mm | 043414 | 284176 |

* Termination Length: 3.7 mm

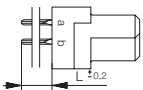
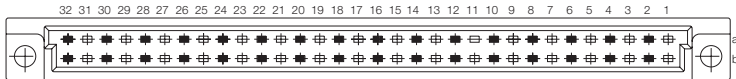
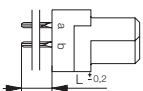
** Termination Length: 4.5 mm

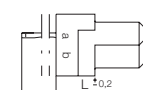
*** Termination Length: 2.9 mm

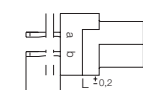
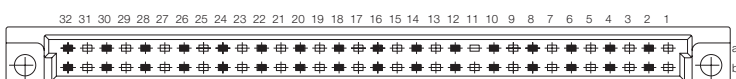
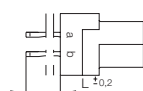
Vertical Female Connectors Type B

| Number of Pins | Termination | Termination Length | Class | Pin Dimensions | Part Number Old Design | Part Number New Design |
|---|--|--------------------|-------|----------------|------------------------|------------------------|
|  |  | | | | | |
| 32 | Solder | 4 mm | 2 | 0.65 x 0.3 mm | 033617 | 284164 |
|  |  | | | | | |
| 64 | Solder | 4 mm | 2 | 0.65 x 0.3 mm | 594080 | 284166 |
| 64 | Solder | 13 mm | 2 | 0.6 x 0.6 mm | 543412 | 284165 |
|  |  | | | | | |
| 32 | Pressfit | 5.5 mm | 2 | 0.6 x 0.6 mm | 023107 | 254848 |
|  |  | | | | | |
| 32 | Pressfit | 5.5 mm | 2 | 0.6 x 0.6 mm | 043175 | 254847 |
|  |  | | | | | |
| 64 | Pressfit | 4 mm | 2 | 0.65 x 0.3 mm | 043073* | 254994 |
| 64 | Pressfit | 5.5 mm | 2 | 0.6 x 0.6 mm | 023108 | 254846 |
| 64 | Pressfit w/o Flange | 5.5 mm | 2 | 0.6 x 0.6 mm | 043543 | 254878 |
| 64 | Pressfit | 5.5 mm | 1 | 0.6 x 0.6 mm | 023367 | 284178 |
| 64 | Pressfit w. Transfer Zone | 17 mm | 2 | 0.6 x 0.6 mm | 023372 | 284179 |

* Termination Length: 3.7 mm



** Termination Length: 4.5 mm

*** Termination Length: 2.9 mm

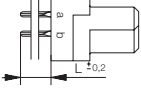
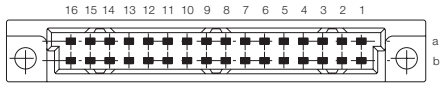
Vertical Female Connectors Type B/2

| Number of Pins | Termination | Termination Length | Class | Pin Dimensions | Part Number Old Design | Part Number New Design |
|---|-------------|--------------------|-------|----------------|------------------------|------------------------|
|   | Solder | 4 mm | 2 | 0.65 x 0.3 mm | 594089 | 284168 |
| | Solder | 13 mm | 2 | 0.6 x 0.6 mm | 414290 | 284167 |

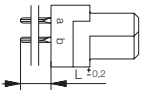
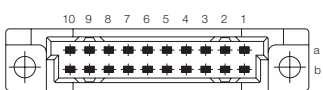
Vertical Female Connectors Type B/3

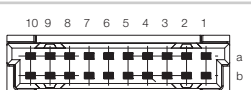
| Number of Pins | Termination | Termination Length | Class | Pin Dimensions | Part Number Old Design | Part Number New Design |
|---|---------------------|--------------------|-------|----------------|------------------------|------------------------|
|   | Solder | 4 mm | 2 | 0.65 x 0.3 mm | 004487 | 254370 |
| | Solder | 13 mm | 2 | 0.6 x 0.6 mm | 424204 | 284169 |
|   | Pressfit w/o Flange | 5.5 mm | 2 | 0.6 x 0.6 mm | 433765 | 234449 |

* Termination Length: 3.7 mm
 ** Termination Length: 4.5 mm
 *** Termination Length: 2.9 mm

Vertical Female Connectors Type CD

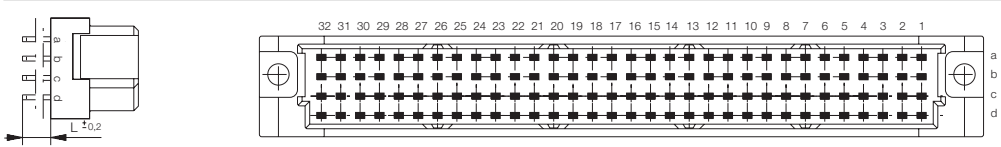
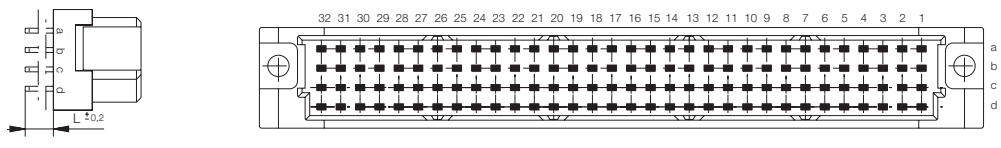
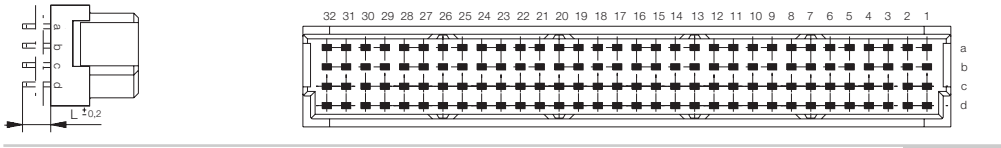
| Number of Pins | Termination | Termination Length | Class | Pin Dimensions | Part Number Old Design | Part Number New Design |
|--|---------------------------|--------------------|-------|----------------|------------------------|------------------------|
|  | | | | | | |
| 128 | Solder | 4 mm | 1 | 0.65 x 0.3 mm | 033299* | 284182 |
| 128 | Solder | 4 mm | 2 | 0.65 x 0.3 mm | 023762* | 254977 |
| 128 | Solder w/o Flange | 4 mm | 2 | 0.65 x 0.3 mm | 024412* | 284180 |
| 128 | Solder with Clip | 4 mm | 2 | 0.65 x 0.3 mm | 063426* | 254978 |
|  | | | | | | |
| 128 | Pressfit | 5.5 mm | 1 | 0.6 x 0.6 mm | 913658 | 254843 |
| 128 | Pressfit w/o Flange | 5.5 mm | 2 | 0.6 x 0.6 mm | 023742 | 254844 |
| 128 | Pressfit | 5.5 mm | 2 | 0.6 x 0.6 mm | 033035 | 244999 |
| 128 | Pressfit w. Transfer Zone | 13 mm | 2 | 0.6 x 0.6 mm | 033223 | 254979 |
| 128 | Pressfit w. Transfer Zone | 17 mm | 2 | 0.6 x 0.6 mm | 033104 | 284181 |
|  | | | | | | |
| 128 | THR w/o Flange | 2.5 mm | 2 | 0.6 x 0.6 mm | 144714 | 284183 |

* Termination Length: 3.7 mm

** Termination Length: 4.5 mm

*** Termination Length: 2.9 mm

Vertical Female Connectors Type E160

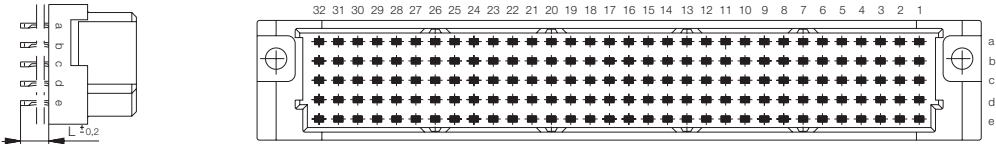
| Number of Pins | Termination | Termination Length | Class | Pin Dimensions | Part Number Old Design | Part Number New Design |
|--|---------------------------|--------------------|-------|----------------|------------------------|------------------------|
|  | | | | | | |
| 160 | Pressfit w/o Flange | 5.5 mm | 2 | 0.6 x 0.6 mm | 043068 | 254840 |
| 160 | Pressfit | 5.5 mm | 2 | 0.6 x 0.6 mm | 004885 | 254006 |
| 160 | Pressfit | 5.5 mm | 1 | 0.6 x 0.6 mm | 023406 | 254839 |
| 160 | Pressfit w. Transfer Zone | 13 mm | 1 | 0.6 x 0.6 mm | 023407 | 284185 |
| 160 | Pressfit w. Transfer Zone | 13 mm | 2 | 0.6 x 0.6 mm | 013315 | 254975 |
| 160 | Pressfit w. Transfer Zone | 17 mm | 2 | 0.6 x 0.6 mm | 004887 | 254960 |
| 160 | Pressfit w. Transfer Zone | 17 mm | 1 | 0.6 x 0.6 mm | 023405 | 284184 |

* Termination Length: 3.7 mm
 ** Termination Length: 4.5 mm
 *** Termination Length: 2.9 mm

Mouser Electronics

Authorized Distributor

Click to View Pricing, Inventory, Delivery & Lifecycle Information:

TE Connectivity:

[254960](#) [254975](#) [284136](#) [224410](#) [244298](#) [244305](#) [254852](#) [254994](#) [254892](#) [254931](#) [254891](#) [254979](#) [284135](#)
[254975-E](#) [254979-E](#) [254960-E](#) [284135-E](#) [284136-E](#)