

PLEASE CHECK WWW.MOLEX.COM FOR LATEST PART INFORMATION

Part Number: [1722872108](#)
Status: **Active**
Overview: [Ultra-Fit Power Connectors](#)
Description: Ultra-Fit Vertical Header, 3.50mm Pitch, Single Row, 8 Circuits, with Solder Clips, Tin (Sn) Plating, Natural, Glow-Wire Capable

Documents:

3D Model	Product Specification PS-172323-0001-001 (PDF)
3D Model (PDF)	Application Specification AS-172323-0001-001 (PDF)
Drawing (PDF)	Packaging Specification PK-172287-9001-001 (PDF)
Product Specification 1723230001-TS-000 (PDF)	Symbol Footprint Data 1722871108-000 (PDF)
Product Specification 1723231000-PS-CH-000 (PDF)	Symbol Footprint Data SYM-172287-1108-001 (PDF)
Product Specification 1723231000-PS-ES-000 (PDF)	RoHS Certificate of Compliance (PDF)
Product Specification 1723231000-PS-JP-000 (PDF)	Product Literature (PDF)
Product Specification 1723231000-PS-SK-000 (PDF)	

Agency Certification

CSA	LR19980
UL	E29179

General

Product Family	PCB Headers
Series	172287
Application	Power, Wire-to-Board
Comments	See Product Specification for maximum current rating by circuit size and wire AWG
Overview	Ultra-Fit Power Connectors
Product Name	Ultra-Fit
UPC	887191736969

Physical

Breakaway	No
Circuits (Loaded)	8
Circuits (maximum)	8
Color - Resin	Natural
Durability (mating cycles max)	25
First Mate / Last Break	No
Flammability	94V-0
Glow-Wire Capable	Yes
Guide to Mating Part	No
Keying to Mating Part	Yes
Lock to Mating Part	Yes
Material - Metal	Copper Alloy
Material - Plating Mating	Tin
Material - Plating Termination	Tin
Material - Resin	Liquid Crystal Polymer
Net Weight	2.386/g
Number of Rows	1
Orientation	Vertical
PC Tail Length	3.20mm
PCB Locator	Yes
PCB Retention	Yes
PCB Thickness - Recommended	1.60mm
Packaging Type	Tray
Pitch - Mating Interface	3.50mm
Pitch - Termination Interface	3.50mm
Plating min - Mating	1.524µm

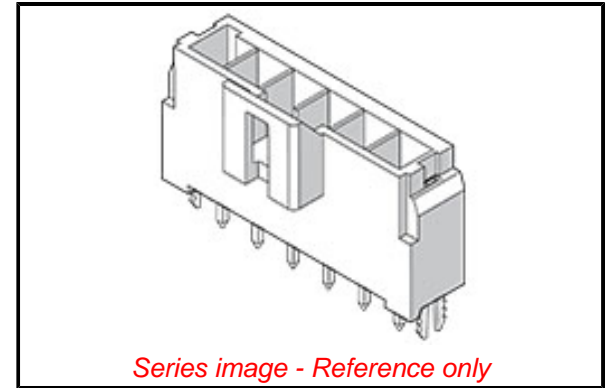

Series image - Reference only

EU ELV

Not Relevant

EU RoHS

Compliant

REACH SVHC

Not Contained Per -
D(2020)9139-DC (19
Jan 2021)

Halogen-Free

Status

Low-Halogen

For more information, please visit [Contact US](#)

China ROHS

ELV

RoHS Phthalates

China RoHS

Green Image

Not Relevant

Not Contained

Search Parts in this Series

[172287 Series](#)

Mates With

Ultra-Fit Receptacle Housing [1722564108](#)

Plating min - Termination	1.524µm
Polarized to Mating Part	Yes
Polarized to PCB	Yes
Shrouded	Fully
Surface Mount Compatible (SMC)	Yes
Temperature Range - Operating	-40° to +105°C
Termination Interface: Style	Through Hole

Electrical

Current - Maximum per Contact	14.0A
Voltage - Maximum	400V AC (RMS)/DC

Solder Process Data

Duration at Max. Process Temperature (seconds)	090
Lead-free Process Capability	WAVE
Max. Cycles at Max. Process Temperature	002
Process Temperature max. C	260

Material Info**Reference - Drawing Numbers**

Application Specification	AS-172323-0001-001
Packaging Specification	PK-172287-9001-001
Product Specification	1723230001-TS-000, 1723231000-PS-CH-000, 1723231000-PS-ES-000, 1723231000-PS-JP-000, 1723231000-PS-SK-000, PS-172323-0001-001
Sales Drawing	SD-172287-1000-000
Symbol/Footprint Data	1722871108-000, SYM-172287-1108-001

This document was generated on 08/23/2021

PLEASE CHECK WWW.MOLEX.COM FOR LATEST PART INFORMATION

Mouser Electronics

Authorized Distributor

Click to View Pricing, Inventory, Delivery & Lifecycle Information:

[Molex:](#)

[172287-2108](#)