

**PLEASE CHECK WWW.MOLEX.COM FOR LATEST PART INFORMATION**

**Part Number:** [1722862205](#)  
**Status:** **Active**  
**Overview:** [Ultra-Fit Power Connectors](#)  
**Description:** Ultra-Fit Vertical Header, 3.50mm Pitch, Single Row, 5 Circuits, with Kinked Pins, 0.38µm Gold (Au) Plating, Natural, Glow-Wire Capable

**Documents:**

<a href="#">3D Model</a>	<a href="#">Product Specification PS-172323-0001-001 (PDF)</a>
<a href="#">Drawing (PDF)</a>	<a href="#">Application Specification AS-172323-0001-001 (PDF)</a>
<a href="#">3D Model (PDF)</a>	<a href="#">Packaging Specification PK-172286-9001-001 (PDF)</a>
<a href="#">Product Specification 1723230001-TS-000 (PDF)</a>	<a href="#">Datasheet (PDF)</a>
<a href="#">Product Specification 1723231000-PS-CH-000 (PDF)</a>	<a href="#">Symbol Footprint Data 1722861105-000 (PDF)</a>
<a href="#">Product Specification 1723231000-PS-ES-000 (PDF)</a>	<a href="#">Symbol Footprint Data SYM-172286-1205-001 (PDF)</a>
<a href="#">Product Specification 1723231000-PS-JP-000 (PDF)</a>	<a href="#">RoHS Certificate of Compliance (PDF)</a>
<a href="#">Product Specification 1723231000-PS-SK-000 (PDF)</a>	

**Agency Certification**

CSA	LR19980
UL	E29179

**General**

Product Family	PCB Headers
Series	<a href="#">172286</a>
Application	Power, Wire-to-Board
Comments	See Product Specification for maximum current rating by circuit size and wire AWG
Overview	<a href="#">Ultra-Fit Power Connectors</a>
Product Name	Ultra-Fit
UPC	887191736587

**Physical**

Breakaway	No
Circuits (Loaded)	5
Circuits (maximum)	5
Color - Resin	Natural
Durability (mating cycles max)	200
First Mate / Last Break	No
Flammability	94V-0
Glow-Wire Capable	Yes
Guide to Mating Part	No
Keying to Mating Part	Yes
Lock to Mating Part	Yes
Material - Metal	Copper Alloy
Material - Plating Mating	Gold
Material - Plating Termination	Tin
Material - Resin	Liquid Crystal Polymer
Net Weight	1.375/g
Number of Rows	1
Orientation	Vertical
PC Tail Length	3.20mm
PCB Locator	Yes
PCB Retention	Yes
PCB Thickness - Recommended	1.60mm
Packaging Type	Tray
Pitch - Mating Interface	3.50mm
Pitch - Termination Interface	3.50mm
Plating min - Mating	0.381µm

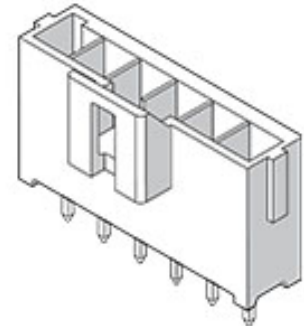

*Series image - Reference only*

**EU ELV**

**Not Relevant**

**EU RoHS**

**Compliant**

**REACH SVHC**

Not Contained Per -  
D(2020)9139-DC (19  
Jan 2021)

**Halogen-Free**

**Status**

**Low-Halogen**

For more information, please visit [Contact US](#)

China ROHS

ELV

RoHS Phthalates

**China RoHS**

Green Image

Not Relevant

Not Contained

**Search Parts in this Series**

[172286 Series](#)

**Mates With**

Ultra-Fit Receptacle Housing [1722564105](#)

Plating min - Termination	1.524µm
Polarized to Mating Part	Yes
Polarized to PCB	Yes
Shrouded	Fully
Surface Mount Compatible (SMC)	Yes
Temperature Range - Operating	-40° to +120°C
Termination Interface: Style	Through Hole - Kinked Pin

**Electrical**

Current - Maximum per Contact	12.0A
Voltage - Maximum	400V AC (RMS)/DC

**Solder Process Data**

Duration at Max. Process Temperature (seconds)	090
Lead-free Process Capability	WAVE
Max. Cycles at Max. Process Temperature	002
Process Temperature max. C	260

**Material Info****Reference - Drawing Numbers**

Application Specification	AS-172323-0001-001
Packaging Specification	PK-172286-9001-001
Product Specification	1723230001-TS-000, 1723231000-PS-CH-000, 1723231000-PS-ES-000, 1723231000-PS-JP-000, 1723231000-PS-SK-000, PS-172323-0001-001
Sales Drawing	SD-172286-1000-000
Symbol/Footprint Data	1722861105-000, SYM-172286-1205-001

This document was generated on 08/24/2021

**PLEASE CHECK [WWW.MOLEX.COM](http://WWW.MOLEX.COM) FOR LATEST PART INFORMATION**

# Mouser Electronics

Authorized Distributor

Click to View Pricing, Inventory, Delivery & Lifecycle Information:

[Molex:](#)

[172286-2205](#)