

- Cable assemblies
- D-Sub / Hoods Centronics
- Multiflex - DIN41651
- Modular
- USB IEEE1394
- Switches
- Powercords Powerleads
- DIN41612 Hardmetric
- MiniDIN
- Sockets / Strips Jumper
- Terminal Blocks
- Memory Card
- FFC / FPC

Der Produktbereich `Stift- und Buchsenleisten` von ASSMANN WSW components stellt eine kostengünstige Alternative zu vergleichbaren Steckverbindersystemen anderer Hersteller dar, mit mehreren in Reihe angeordneten Kontakten. Diese Produkte finden ihren Einsatz in nahezu allen Anwendermärkten, die elektronische oder elektrische Systeme herstellen und zwei Platinen miteinander verbinden wollen. Die Produktpalette von ASSMANN WSW components beinhaltet sämtliche gängigen Kontaktraster von 5,08mm, 2.54mm, 2.00mm über 1.27mm bis hin zu Steckverbindern im Raster 1.00mm und 0,50mm. Neben den Standardkontaktlängen sind natürlich auch kundenspezifische Kontaktlängen auf Anfrage herstellbar. ASSMANN WSW components bietet zudem die Möglichkeit an, mehrere Platinen übereinander und nebeneinander zu verbinden, indem sogenannte `Platinenstapler` oder auch `Sandwich-Stiftleisten` verwendet werden. Diese haben zwei Isolierkörper (Position des Isolierkörpers kann variabel festgelegt werden) und werden an beiden Enden auf die Leiterplatte gelötet. Stift- und Buchsenleisten sind mit geraden oder abgewinkelten Kontakten, mit SMD - Kontakten (Surface Mount Technology) oder in THT (Through Hole Technology), mit verschiedensten Stiftlängen, sowie mit runden oder Vierkantstiften erhältlich.

ASSMANN WSW components bietet darüber hinaus einen Musterservice an, der speziell bei kurzfristigen Bemusterungen, innerhalb 3-5 Tagen nach Bestellung, greift.

Die auf den folgenden Seiten gezeigten Produkte stellen die Standardproduktpalette dar. Neben dem sogenannten Standard fertigen wir eine große Menge von Sondertypen und kundenspezifischen Produkten.

The product portfolio `pin headers and female headers` from ASSMANN WSW components is a reasonable alternative compared with comparable connector systems of other connector producers, showing the standard features like different contact numbers, stitched or overmoulded in rows and based on dedicated pitches. These kind of products will be found in nearly every application and market, which is producing electronic- or electrical devices and which need to connect two pcbs together. The product range from ASSMANN WSW components contains a full variety of common used pitches as there are 5.08 mm, 2.54 mm, 2.00 mm, 1.27 mm until 1.00 mm and 0.50 mm. Beside the standard contact lengths we produce as well custom specific contact lengths upon request. ASSMANN WSW components do offer in addition to this program the possibility to connect pcbs in sandwich style on top of each other by using so called `sandwich pin headers`. These connectors do have two insulator bodies (position of the insulator can be fixed according to request) and will be soldered at both contact ends into the pcb. Male and female headers are available with straight or right-angle contacts, with SMT (surface mount technology) or with THT (trough hole technology) contact styles, using different contact lengths, round or square contacts.

ASSMANN WSW components offers in addition to the `of the shelf program` a sample service, which has been installed especially for short term design-ins, shipment within 3-5 days after receipt of order. The following pages do show the standard product range of male and female headers. Beside that, a lot of special or custom specific headers are available or can be produced upon request.

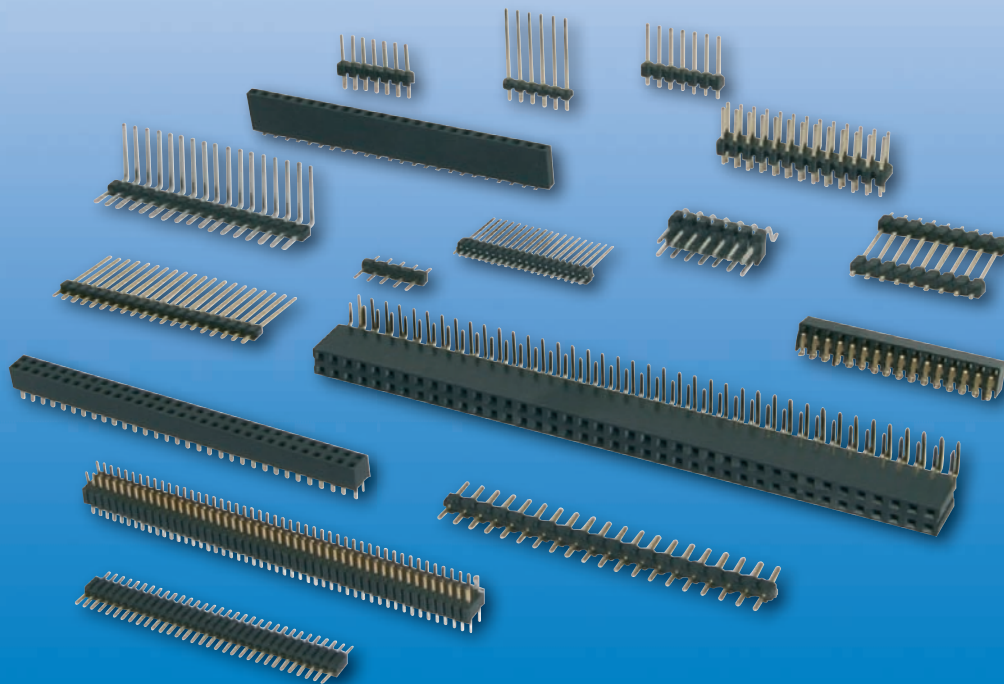

Produktbeschreibung

Seite

Stiftleiste, Raster 2.54mm, gerade, einreihig	262
Stiftleiste, Raster 2.54mm, abgewinkelt, einreihig	263
Stiftleiste, Raster 2.54mm, gerade, einreihig, flacher Isolierkörper	264
Stiftleiste, Raster 2.54mm, gerade, einreihig, gedrehte Stifte	266
Stiftleiste, Raster 2.54mm, gerade, einreihig	267
Stiftleiste, Raster 2.54mm, gerade, zweireihig	268
Stiftleiste, Raster 2.54mm, abgewinkelt, zweireihig	269
Stiftleiste, Raster 2.00mm, gerade, einreihig	270
Stiftleiste, Raster 2.00mm, abgewinkelt, einreihig	271
Stiftleiste, Raster 2.00mm, gerade, zweireihig	272
Stiftleiste, Raster 2.00mm, abgewinkelt, zweireihig	273
Stiftleiste, Raster 1.27mm, gerade, einreihig	274
Stiftleiste, Raster 1.27mm, gerade, zweireihig	275
Übersicht Dual-Body-Stiftleisten	276
Buchsenleiste, Raster 2.54mm, gerade, einreihig	277
Buchsenleiste, Raster 2.54mm, abgewinkelt, einreihig	278
Buchsenleiste, Raster 2.54mm, gerade, zweireihig	279
Buchsenleiste, Raster 2.54mm, abgewinkelt, zweireihig	280
Buchsenleiste, Raster 2.00mm, gerade, einreihig	281
Buchsenleiste, Raster 2.00mm, abgewinkelt, einreihig	282
Buchsenleiste, Raster 2.00mm, gerade, zweireihig	283
Buchsenleiste, Raster 2.00mm, abgewinkelt, zweireihig	284
Buchsenleiste, Raster 1.27mm, gerade, einreihig	285
Buchsenleiste, Raster 1.27mm, gerade, zweireihig	286

Product description

page

Pin header, pitch 2.54mm, straight, single row	262
Pin header, pitch 2.54mm, right-angled, single row	263
Pin header, pitch 2.54mm, straight, single row, low profile isulator	264
Pin header, pitch 2.54mm, straight, single row, machined pins	266
Pin header, pitch 2.54mm, straight, single row	267
Pin header, pitch 2.54mm, straight, double row	268
Pin header, pitch 2.54mm, right-angled, double row	269
Pin header, pitch 2.00mm, straight single row	270
Pin header, pitch 2.00mm, right-angled single row	271
Pin header, pitch 2.00mm, straight, double row	272
Pin header, pitch 2.00mm, angled, double row	273
Pin header, pitch 1.27mm, straight, single row	274
Pin header, pitch 1.27mm, straight, double row	275
Overview Dual-Body-Pinheaders	276
Female header, pitch 2.54mm, straight, single row	277
Female header, pitch 2.54mm, right-angled, single row	278
Female header, pitch 2.54mm, straight, double row	279
Female header, pitch 2.54mm, right-angled, double row	280
Female header, pitch 2.00mm, straight, single row	281
Female header, pitch 2.00mm, right-angled, single row	282
Female header, pitch 2.00mm, straight, double row	283
Female header, pitch 2.00mm, right-angled, double row	284
Female header, pitch 1.27mm, straight, single row	285
Female header, pitch 1.27mm, straight, double row	286



Cable assemblies
D-Sub / Hoods Centronics
Multiflex - DIN41651
Modular
USB IEEE1394
Switches
Powercards Powerinlets
DIN41612 Hardmetric
MiniDIN
Sockets / Strips Jumper
Terminal Blocks
Memory Card
FFC / FPC

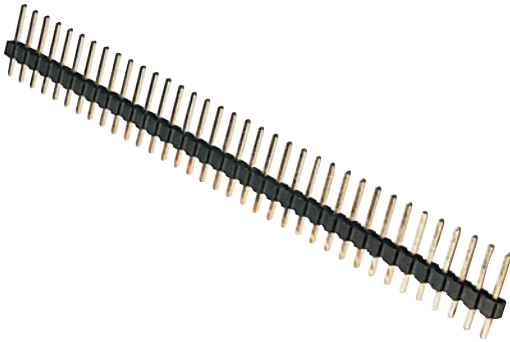

Isolierkörpermaterial
PBT, UL94V-0

Kontaktmaterial
Messing

Kontaktfläche
Ni, Au or Sn

Kontaktwiderstand
20mΩ max

Isolationswiderstand
1000MΩ min

Strombelastbarkeit
1.5A

Betriebstemperatur
-40°C - +105°C

Betriebsspannung
250V AC

Prüfspannung
500V AC

Verpackung
Kunststoffbeutelverpackung

Insulator material
PBT, UL94V-0

Contact material
Brass

Plating
Ni, Au or Sn

Contact resistance
20mΩ max

Insulation resistance
1000MΩ min

Current rating
1.5A

Operating temperature
-40°C - +105°C

Operating voltage
250V AC

Test voltage
500V AC

Packing
Polybag packing

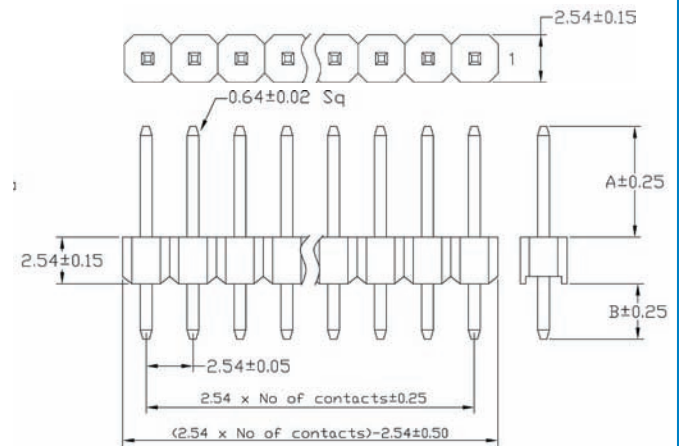
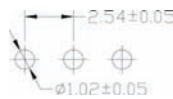

Bestellcode / Ordercode

Kontaktfläche

G - Gold Flash
Z - verzinkt

Plating

G - Gold flash
Z - Tinned

Polzahl

02 - 40

No. of contacts

02 - 40

Stiftlänge

D - 11.2mm (A=5.66; B=3.00)
A - 12.4mm (A=6.08; B=3.78)
B - 11.6mm (A=6.06; B=3.00)
C1 - 13.6mm (A=8.75; B=2.31)
C2 - 13.6mm (A=6.08; B=4.98)
E - 21.1mm (A=12.6; B=5.96)
F - 9.2mm (A=3.66; B=3.00)

Pin length

D - 11.2mm (A=5.66; B=3.00)
A - 12.4mm (A=6.08; B=3.78)
B - 11.6mm (A=6.06; B=3.00)
C1 - 13.6mm (A=8.75; B=2.31)
C2 - 13.6mm (A=6.08; B=4.98)
E - 21.1mm (A=12.6; B=5.96)
F - 9.2mm (A=3.66; B=3.00)

AW 140 E - G x - xx x

Bitte „x“ durch die geeignete Option ersetzen
Please replace „x“ with appropriate option

Isolierkörpermaterial

PBT, UL94V-0

Kontaktmaterial

Messing

Kontaktfläche

Ni, Au or Sn

Kontaktwiderstand

20mΩ max

Isolationswiderstand

1000MΩ min

Strombelastbarkeit

1.5A

Betriebstemperatur

-40°C - +105°C

Betriebsspannung

250V AC

Prüfspannung

500V AC

Verpackung

Kunststoffbeutelverpackung

Insulator material

PBT, UL94V-0

Contact material

Brass

Plating

Ni, Au or Sn

Contact resistance

20mΩ max

Insulation resistance

1000MΩ min

Current rating

1.5A

Operating temperature

-40°C - +105°C

Operating voltage

250V AC

Test voltage

500V AC

Packing

Polybag packing

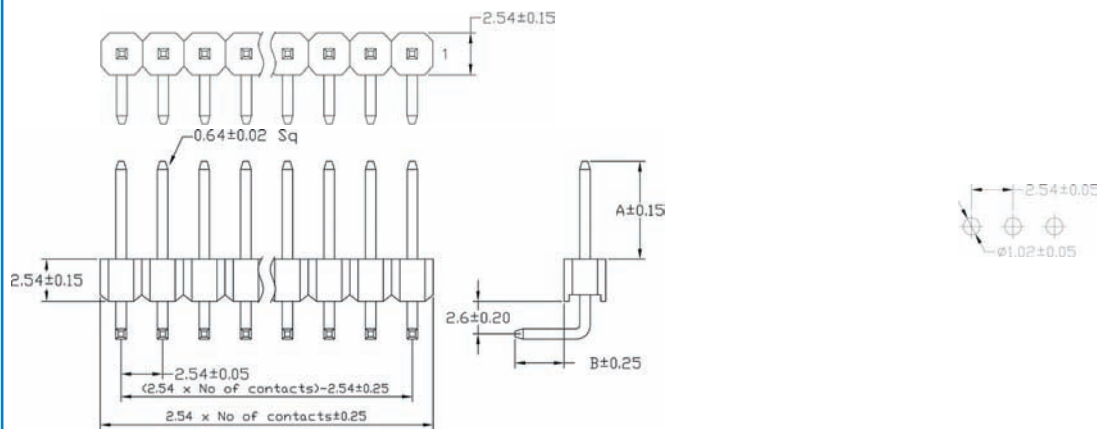
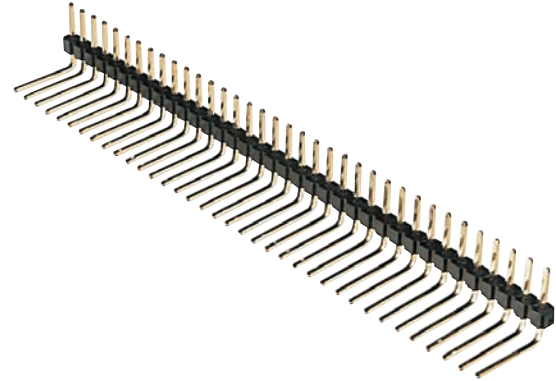

Bestellcode / Ordercode

Kontaktfläche

- G - Gold Flash
- Z - verzinkt

Polzahl

02 - 40

Stiftlänge

- G - 13mm (A=5.72; B=2.4)
- H - 15mm (A=5.72; B=4.6)
- I - 21mm (A=5.72; B=9.8)

Plating

- G - Gold flash
- Z - Tinned

No. of contacts

02 - 40

Pin length

- G - 13mm (A=5.72; B=2.4)
- H - 15mm (A=5.72; B=4.6)
- I - 21mm (A=5.72; B=9.8)

AW 140 - E A - x xx x

Bitte „x“ durch die geeignete Option ersetzen
 Please replace „x“ with appropriate option

- Cable assemblies
- D-Sub / Hoods Centronics
- Multiflex - DIN41651
- Modular
- USB IEEE1394
- Switches
- Powercards Powerinlets
- DIN41612 Hardmetric
- MiniDIN
- Sockets / Strips Jumper
- Terminal Blocks
- Memory Card
- FFC / FPC

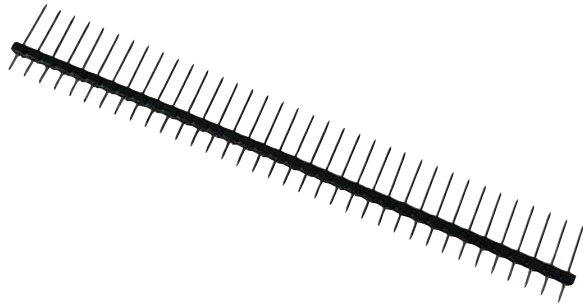

Isolierkörpermaterial
PA 4.6, UL94V-0

Kontaktmaterial
Messing

Kontaktoberfläche
Ni, Au

Kontaktwiderstand
20mΩ max

Isolationswiderstand
1000MΩ min

Strombelastbarkeit
3A

Betriebstemperatur
-40°C - +105°C

Betriebsspannung
250V AC

Prüfspannung
1000V AC

Verpackung
Kunststoffbeutelverpackung

Insulator material
PA 4.6, UL94V-0

Contact material
Brass

Plating
Ni, Au

Contact resistance
20mΩ max

Insulation resistance
1000MΩ min

Current rating
3A

Operating temperature
-40°C - +105°C

Operating voltage
250V AC

Test voltage
1000V AC

Packing
Polybag packing

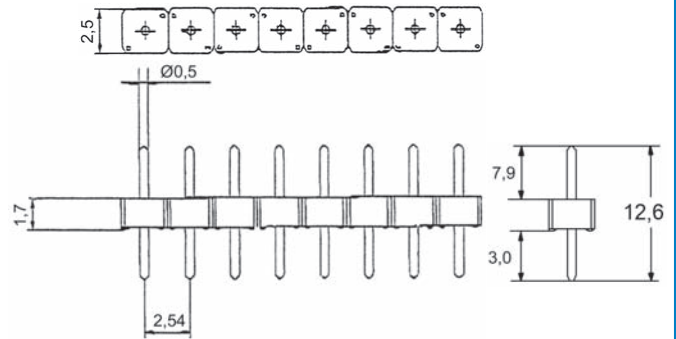

Bestellcode / Ordercode

Polzahl
02 - 36

No. of contacts
02 - 36

AP 119 xx / G - N

Cable
assemblies

D-Sub / Hoods
Centronics

Multiflex -
DIN41651

Modular

USB
IEEE1394

Switches

Powercords
Powerlets

DIN41612
Hardmetric

MiniDIN

Sockets / Strips
Jumper

Terminal Blocks

Memory Card

FFC / FPC

Isolierkörpermaterial

PBT, UL94V-0

Kontaktmaterial

Messing

Kontaktfläche

Ni, Au

Kontaktwiderstand

20mΩ max

Isolationswiderstand

1000MΩ min

Strombelastbarkeit

1.5A

Betriebstemperatur

-40°C - +105°C

Betriebsspannung

250V AC

Prüfspannung

1000V AC

Verpackung

Kunststoffbeutelverpackung

Insulator material

PBT, UL94V-0

Contact material

Brass

Plating

Ni, Au

Contact resistance

20mΩ max

Insulation resistance

1000MΩ min

Current rating

1.5A

Operating temperature

-40°C - +105°C

Operating voltage

250V AC

Test voltage

1000V AC

Packing

Polybag packing

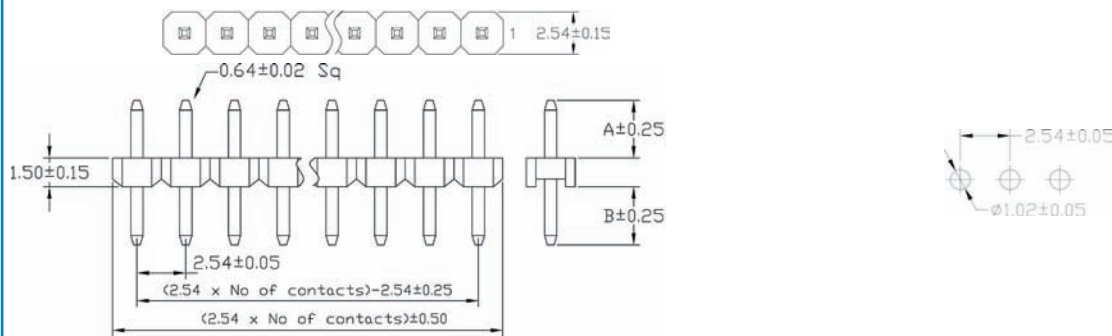
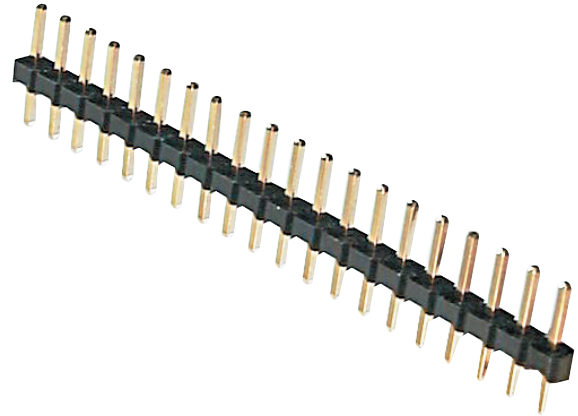

Bestellcode / Ordercode

Stiftlänge

- 08 - 12.4mm (A= 7.9, B=3.0)
- 09 - 11.2mm (A= 6.7, B=3.0)
- 10 - 9.2mm (A= 4.7, B=3.0)
- 13 - 20.0mm (A=15.6, B=3.0)

Polzahl

02 - 20

Standard : 20polig

Pin length

- 08 - 12.4mm (A= 7.9, B=3.0)
- 09 - 11.2mm (A= 6.7, B=3.0)
- 10 - 9.2mm (A= 4.7, B=3.0)
- 13 - 20.0mm (A=15.6, B=3.0)

No. of contacts

02 - 20

Standard : 20-contacts

AW 1 x / xx - T

Bitte „x“ durch die geeignete Option ersetzen
 Please replace „x“ with appropriate option

Cable assemblies

D-Sub / Hoods Centronics

Multiflex - DIN41651

Modular

USB IEEE1394

Switches

Powercords Powerinlets

DIN41612 Hardmetric

MiniDIN

Sockets / Strips Jumper

Terminal Blocks

Memory Card

FFC / FPC

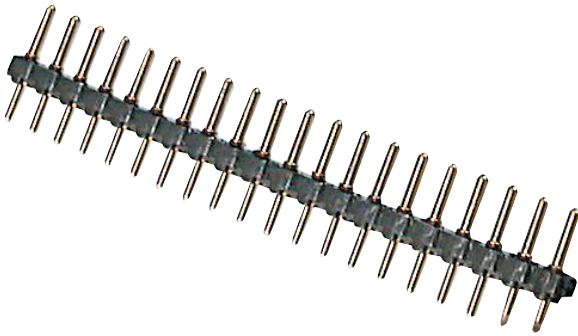

Isolierkörpermaterial
PBT, UL94V-0

Kontaktmaterial
Messing

Kontaktoberfläche
Ni, Au

Kontaktwiderstand
20mΩ max

Isolationswiderstand
10⁴Ω min

Strombelastbarkeit
1.5A

Betriebstemperatur
-55°C - +125°C

Betriebsspannung
250V AC

Prüfspannung
1000V AC

Verpackung
Kunststoffbeutelverpackung

Insulator material
PBT, UL94V-0

Contact material
Brass

Plating
Ni, Au

Contact resistance
20mΩ max

Insulation resistance
10⁴Ω min

Current rating
1.5A

Operating temperature
-55°C - +125°C

Operating voltage
250V AC

Test voltage
1000V AC

Packing
Polybag packing

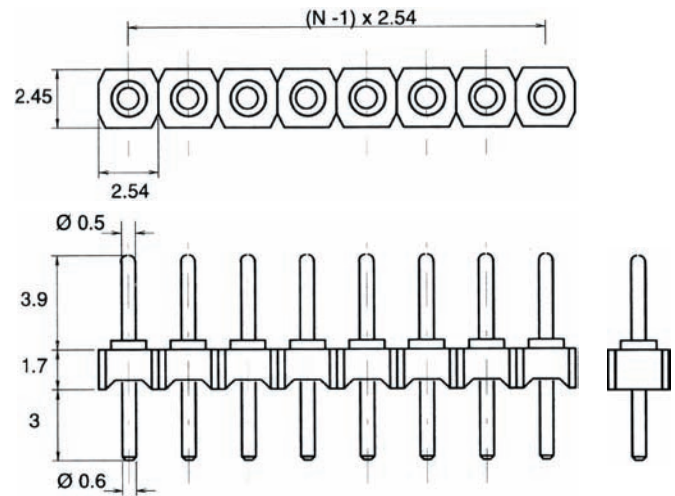
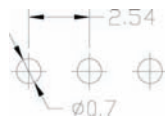

Bestellcode / Ordercode

Standard : 20polig

Standard : 20-contacts

AP - 120

Cable
assemblies

D-Sub / Hoods
Centronics

Multiflex -
DIN41651

Modular

USB
IEEE1394

Switches

Powercords
Powerlets

DIN41612
Hardmetric

MiniDIN

Sockets / Strips
Jumper

Terminal Blocks

Memory Card

FFC / FPC

Isolierkörpermaterial

Nylon 6T, UL94V-0

Kontaktmaterial

Messing

Kontaktfläche

Ni, Au

Kontaktwiderstand

20mΩ max

Isolationswiderstand

1000MΩ min

Strombelastbarkeit

3A

Betriebstemperatur

-55°C - +105°C

Betriebsspannung

250V AC

Prüfspannung

1000V AC

Verpackung

Kunststoffbeutelverpackung

Insulator material

Nylon 6T, UL94V-0

Contact material

Brass

Plating

Ni, Au

Contact resistance

20mΩ max

Insulation resistance

1000MΩ min

Current rating

3A

Operating temperature

-55°C - +105°C

Operating voltage

250V AC

Test voltage

1000V AC

Packing

Polybag packing

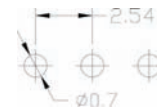
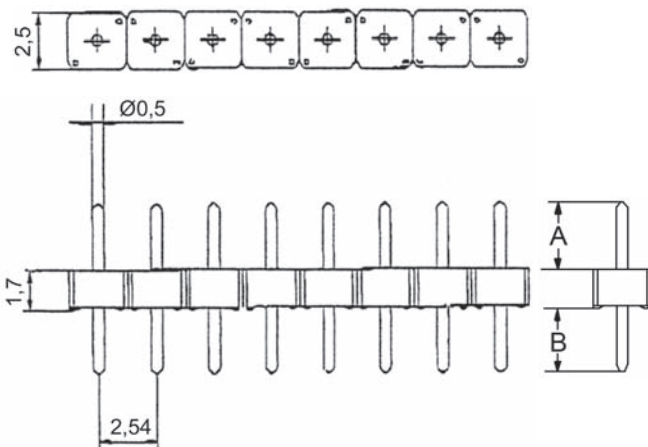
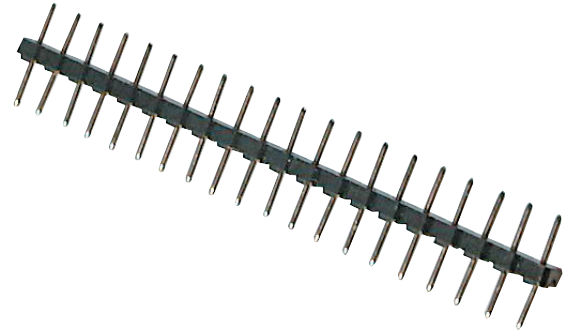

Bestellcode / Ordercode

Polzahl

04 - 36

No. of contacts

04 - 36

Stiftlänge

N - 8.7mm (A=4.0, B=3.0)

A - 7.2mm (A=2.5, B=3.0)

Pin length

N - 8.7mm (A=4.0, B=3.0)

A - 7.2mm (A=2.5, B=3.0)

AW 126 - xx / G - x

Cable assemblies

D-Sub / Hoods
Centronics

Multiflex -
DIN41651

Modular

USB
IEEE1394

Switches

Powercards
Powerinlets

DIN41612
Hardmetric

MiniDIN

Sockets / Strips
Jumper

Terminal Blocks

Memory Card

FFC / FPC

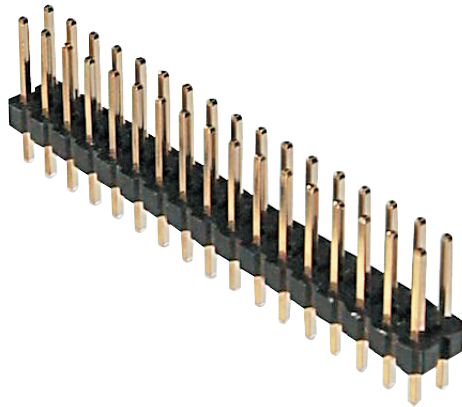

Isolierkörpermaterial
PBT, UL94V-0

Kontaktmaterial
Messing

Kontaktoberfläche
Ni, Au oder Sn

Kontaktwiderstand
20mΩ max

Isolationswiderstand
1000MΩ min

Strombelastbarkeit
1.5A

Betriebstemperatur
-40°C - +105°C

Betriebsspannung
250V AC

Prüfspannung
1000V AC

Verpackung
Kunststoffbeutelverpackung

Insulator material
PBT, UL94V-0

Contact material
Brass

Plating
Ni, Au or Sn

Contact resistance
20mΩ max

Insulation resistance
1000MΩ min

Current rating
1.5A

Operating temperature
-40°C - +105°C

Operating voltage
250V AC

Test voltage
1000V AC

Packing
Polybag packing

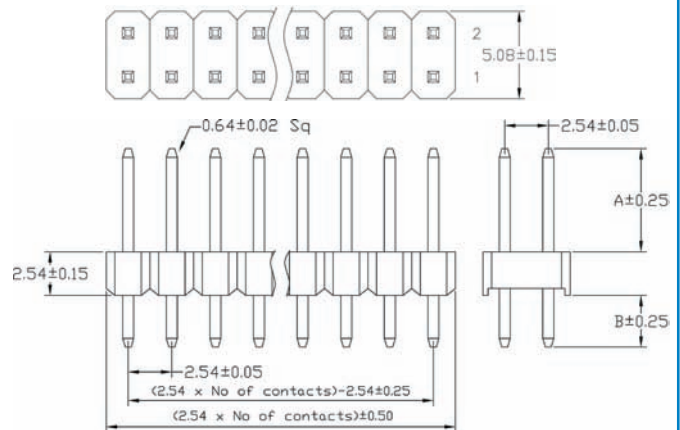
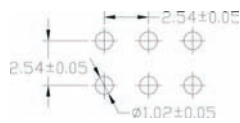

Bestellcode / Ordercode

Kontaktoberfläche

G - Gold Flash
Z - Verzinkt

Polzahl

04 - 80

Stiftlänge

D - A=6mm, B=3mm
A - A=7mm, B=3mm

Plating

G - Gold flash
Z - Tinned

No. of contacts

04 - 80

Pin length

D - A=6mm, B=3mm
A - A=7mm, B=3mm

AWL254 - D G - x xx x

Bitte „x“ durch die geeignete Option ersetzen
Please replace „x“ with appropriate option

- Cable assemblies
- D-Sub / Hoods Centronics
- Multiflex - DIN41691
- Modular
- USB IEEE1394
- Switches
- Powercords Powerlets
- DIN41612 Hardmetric
- MiniDIN
- Sockets / Strips Jumper
- Terminal Blocks
- Memory Card
- FFC / FPC

Isolierkörpermaterial

PBT, UL94V-0

Kontaktmaterial

Messing

Kontaktfläche

Ni, Au oder Sn

Kontaktwiderstand

20mΩ max

Isolationswiderstand

1000MΩ min

Strombelastbarkeit

1.5A

Betriebstemperatur

-40°C - +105°C

Betriebsspannung

250V AC

Prüfspannung

1000V AC

Verpackung

Kunststoffbeutelverpackung

Insulator material

PBT, UL94V-0

Contact material

Brass

Plating

Ni, Au or Sn

Contact resistance

20mΩ max

Insulation resistance

1000MΩ min

Current rating

1.5A

Operating temperature

-40°C - +105°C

Operating voltage

250V AC

Test voltage

1000V AC

Packing

Polybag packing

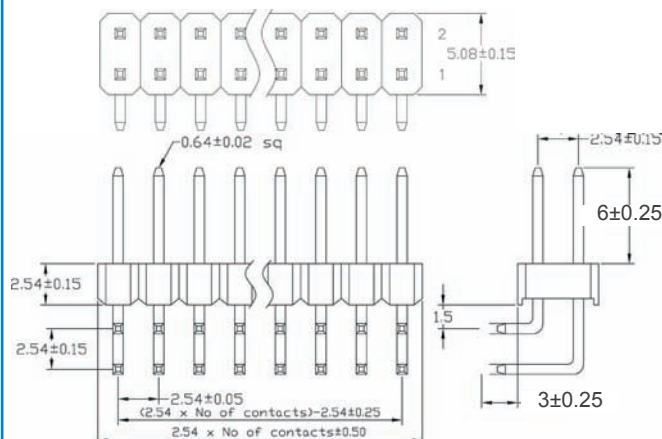
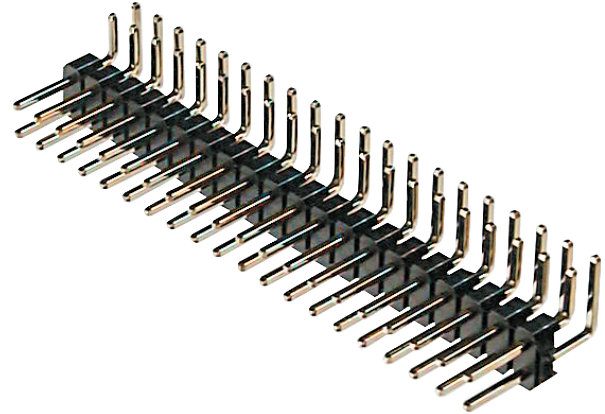

Bestellcode / Ordercode

Kontaktfläche

G - Gold Flash
 Z - Verzinkt

Polzahl

04 - 80

Stiftlänge

D - A = 6mm, B = 3mm

Plating

G - Gold flash
 Z - Tinned

No. of contacts

04 - 80

Pin length

D - A = 6mm, B = 3mm

AWL254 - D A - x xx D

Bitte „x“ durch die geeignete Option ersetzen
 Please replace „x“ with appropriate option

Cable assemblies

D-Sub / Hoods Centronics

Multiflex - DIN41651

Modular

USB IEEE1394

Switches

Powercords Powerinlets

DIN41612 Hardmetric

MiniDIN

Sockets / Strips Jumper

Terminal Blocks

Memory Card

FFC / FPC

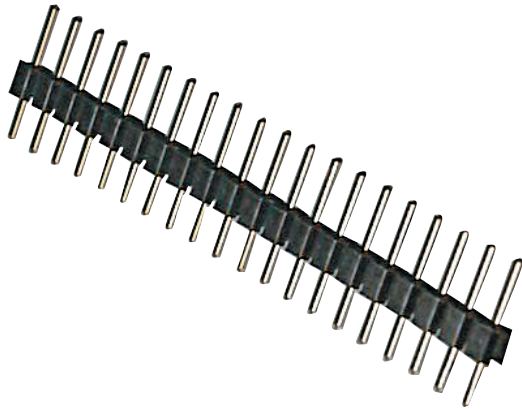

Isolierkörpermaterial
PBT, UL94V-0

Kontaktmaterial
Messing

Kontaktoberfläche
Ni, Au oder Sn

Kontaktwiderstand
20mΩ max

Isolationswiderstand
1000MΩ min

Strombelastbarkeit
1A

Betriebstemperatur
-40°C - +105°C

Betriebsspannung
125V AC

Prüfspannung
500V AC

Verpackung
Kunststoffbeutelverpackung

Insulator material
PBT, UL94V-0

Contact material
Brass

Plating
Ni, Au or Sn

Contact resistance
20mΩ max

Insulation resistance
1000MΩ min

Current rating
1A

Operating temperature
-40°C - +105°C

Operating voltage
125V AC

Test voltage
500V AC

Packing
Polybag packing

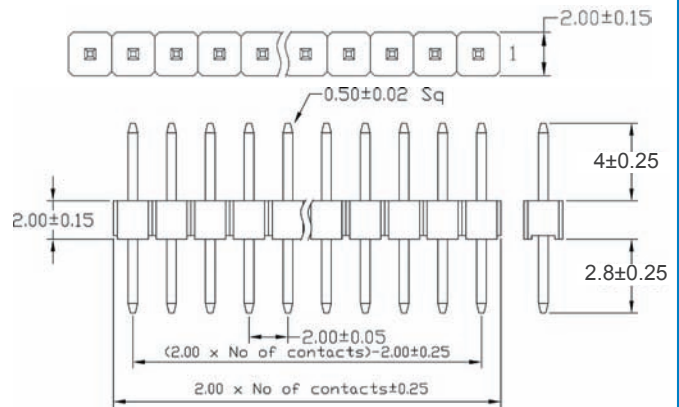
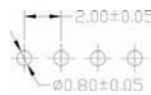

Bestellcode / Ordercode

Kontaktoberfläche

G - Gold Flash
Z - Verzinkt

Polzahl

02 - 40

Stiftlänge

D - A = 4mm, B = 2.8mm

Plating

G - Gold flash
Z - Tinned

No. of contacts

02 - 40

Pin length

D - A = 4mm, B = 2.8mm

A - SL200 - E G - x xx D

Bitte „x“ durch die geeignete Option ersetzen
Please replace „x“ with appropriate option

Cable assemblies

D-Sub / Hoods Centronics

Multiflex - DIN41651

Modular

USB IEEE1394

Switches

Powercords Powerlets

DIN41612 Hardmetric

MiniDIN

Sockets / Strips Jumper

Terminal Blocks

Memory Card

FFC / FPC

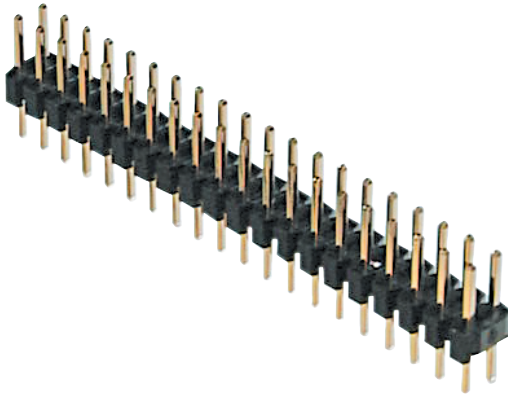

Isolierkörpermaterial
PBT, UL94V-0

Kontaktmaterial
Messing

Kontaktoberfläche
Ni, Au oder Sn

Kontaktwiderstand
20mΩ max

Isolationswiderstand
1000MΩ min

Strombelastbarkeit
1A

Betriebstemperatur
-40°C - +105°C

Betriebsspannung
125V AC

Prüfspannung
500V AC

Verpackung
Kunststoffbeutelverpackung

Insulator material
PBT, UL94V-0

Contact material
Brass

Plating
Ni, Au or Sn

Contact resistance
20mΩ max

Insulation resistance
1000MΩ min

Current rating
1A

Operating temperature
-40°C - +105°C

Operating voltage
125V AC

Test voltage
500V AC

Packing
Polybag packing

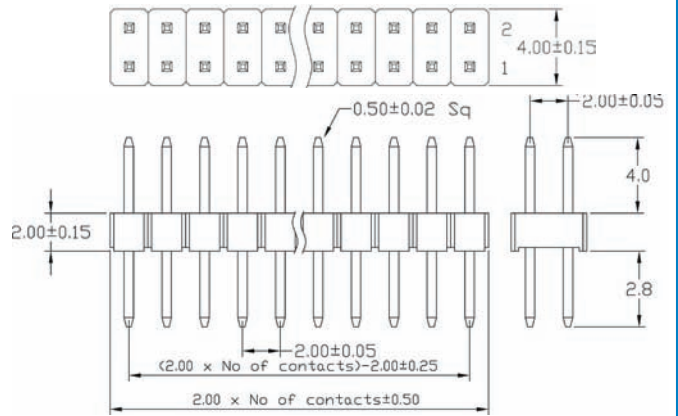
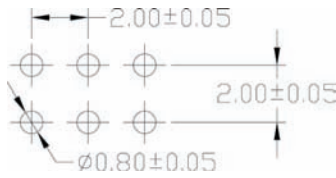

Bestellcode / Ordercode

Kontaktoberfläche

G - Gold Flash
Z - Verzinkt

Polzahl

04 - 80

Stiftlänge

D - A = 4mm, B = 2.8mm

Plating

G - Gold flash
Z - Tinned

No of contacts

04 - 80

Pin length

D - A = 4mm, B = 2.8mm

A - SL200 - D G - x xx D

Bitte „x“ durch die geeignete Option ersetzen
 Please replace „x“ with appropriate option

Cable assemblies

D-Sub / Hoods Centronics

Multiflex - DIN41651

Modular

USB IEEE1394

Switches

Powercords Powerlets

DIN41612 Hardmetric

MiniDIN

Sockets / Strips Jumper

Terminal Blocks

Memory Card

FFC / FPC

Isolierkörpermaterial

PBT, UL94V-0

Kontaktmaterial

Messing

Kontaktfläche

Ni, Au oder Sn

Kontaktwiderstand

20mΩ max

Isolationswiderstand

1000MΩ min

Strombelastbarkeit

1A

Betriebstemperatur

-40°C - +105°C

Betriebsspannung

125V AC

Prüfspannung

500V AC

Verpackung

Kunststoffbeutelverpackung

Insulator material

PBT, UL94V-0

Contact material

Brass

Plating

Ni, Au or Sn

Contact resistance

20mΩ max

Insulation resistance

1000MΩ min

Current rating

1A

Operating temperature

-40°C - +105°C

Operating voltage

125V AC

Test voltage

500V AC

Packing

Polybag packing

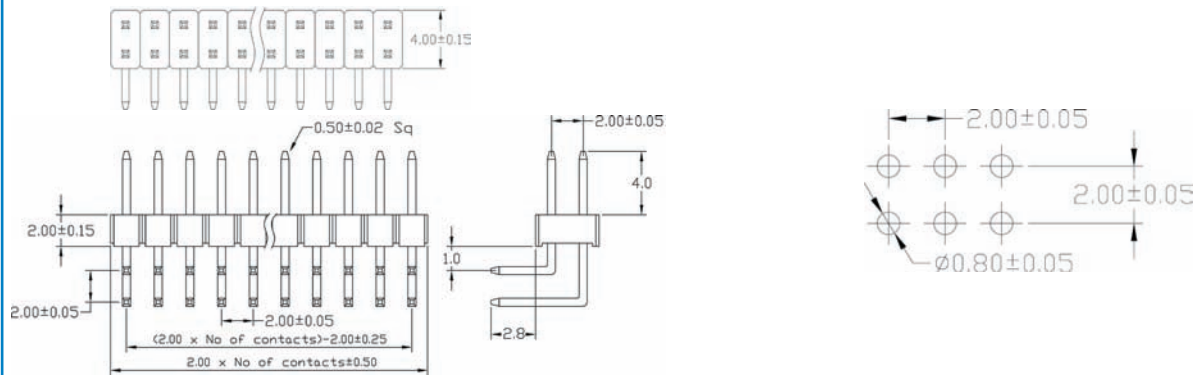
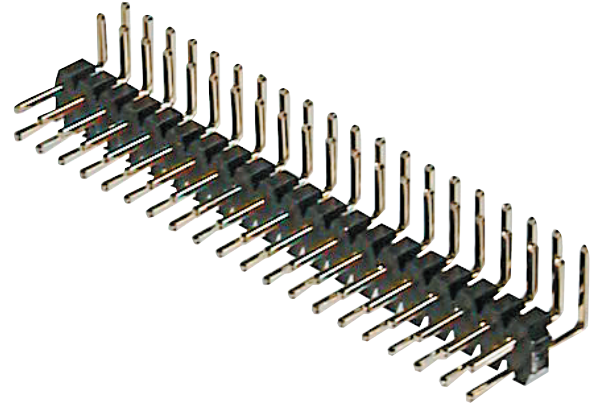

Bestellcode / Ordercode

Kontaktfläche

G - Gold Flash
 Z - Verzinkt

Polzahl

04 - 80

Stiftlänge

D - A = 4mm, B = 2.8mm

Plating

G - Gold flash
 Z - Tinned

No of contacts

04 - 80

Pin length

D - A = 4mm, B = 2.8mm

A - SL200 - D A - x xx D

Bitte „x“ durch die geeignete Option ersetzen
 Please replace „x“ with appropriate option

Cable assemblies

D-Sub / Hoods Centronics

Multiflex - DIN41651

Modular

USB IEEE1394

Switches

Powercords Powernets

DIN41612 Hardmetric

MiniDIN

Sockets / Strips Jumper

Terminal Blocks

Memory Card

FFC / FPC



Isolierkörpermaterial
Nylon 6T, UL94V-0

Kontaktmaterial
Messing

Kontaktoberfläche
Ni, Au oder Sn

Kontaktwiderstand
20mΩ max

Isolationswiderstand
500MΩ min

Strombelastbarkeit
1A

Betriebstemperatur
-40°C - +105°C

Betriebsspannung
125V AC

Prüfspannung
500V AC

Verpackung
Kunststoffbeutelverpackung

Insulator material
Nylon 6T, UL94V-0

Contact material
Brass

Plating
Ni, Au or Sn

Contact resistance
20mΩ max

Insulation resistance
500MΩ min

Current rating
1A

Operating temperature
-40°C - +105°C

Operating voltage
125V AC

Test voltage
500V AC

Packing
Polybag packing

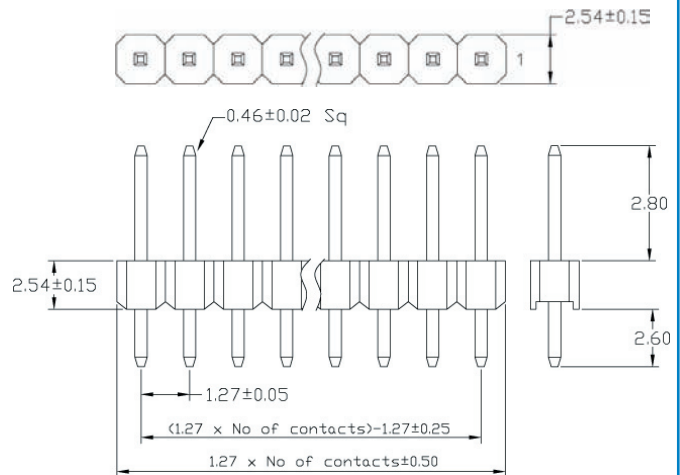
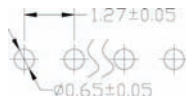

Bestellcode / Ordercode

Kontaktoberfläche

G - Gold Flash
Z - Verzinkt

Polzahl

02 - 50

Stiftlänge

D - A = 2.8mm, B = 2.6mm

Plating

G - Gold flash
Z - Tinned

No. of contacts

02 - 50

Pin length

D - A = 2.8mm, B = 2.6mm

A - SL127 - E G - x xx D

Bitte „x“ durch die geeignete Option ersetzen
Please replace „x“ with appropriate option

Cable assemblies

D-Sub / Hoods Centronics

Multiflex - DIN41691

Modular

USB IEEE1394

Switches

Powercords Powerlets

DIN41612 Hardmetric

MiniDIN

Sockets / Strips Jumper

Terminal Blocks

Memory Card

FFC / FPC

Isolierkörpermaterial

Nylon 6T, UL94V-0

Kontaktmaterial

Messing

Kontaktfläche

Ni, Au oder Sn

Kontaktwiderstand

20mΩ max

Isolationswiderstand

500MΩ min

Strombelastbarkeit

1A

Betriebstemperatur

-40°C - +105°C

Betriebsspannung

125V AC

Prüfspannung

500V AC

Verpackung

Kunststoffbeutelverpackung

Insulator material

Nylon 6T, UL94V-0

Contact material

Brass

Plating

Ni, Au or Sn

Contact resistance

20mΩ max

Insulation resistance

500MΩ min

Current rating

1A

Operating temperature

-40°C - +105°C

Operating voltage

125V AC

Test voltage

500V AC

Packing

Polybag packing

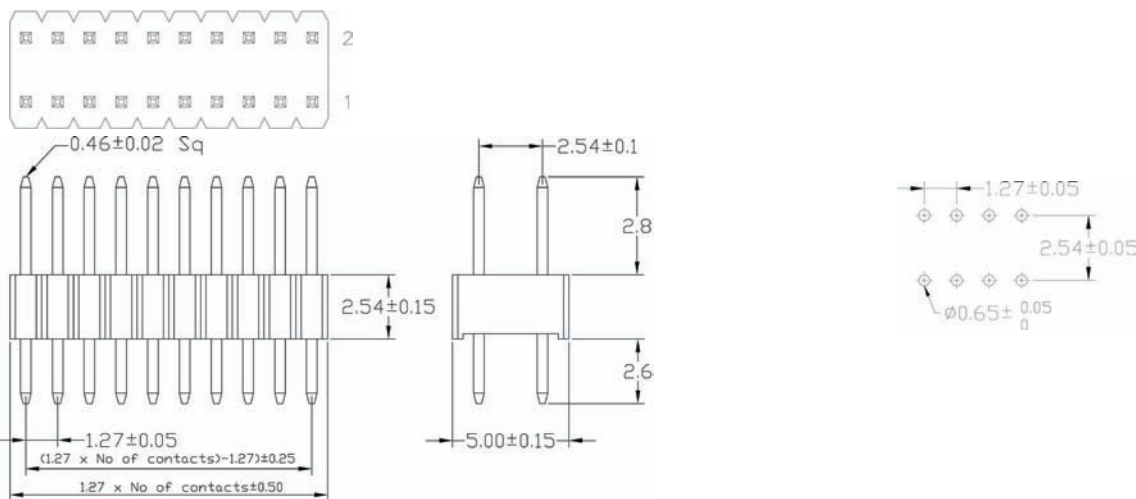
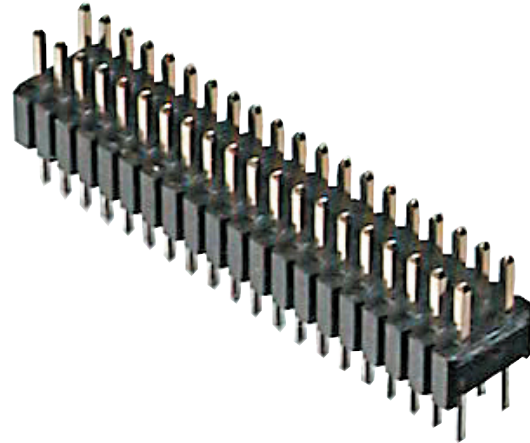

Bestellcode / Ordercode

Kontaktfläche

G - Gold Flash
 Z - Verzinkt

Polzahl

06 - 100

Stiftlänge

D - A = 2.8mm, B = 2.6mm

Plating

G - Gold flash
 Z - Tinned

No. of contacts

06 - 100

Pin length

D - A = 2.8mm, B = 2.6mm

A - SL127 - D G - x xx D

Bitte „x“ durch die geeignete Option ersetzen
 Please replace „x“ with appropriate option

- Cable assemblies
- D-Sub / Hoods Centronics
- Multiflex - DIN41651
- Modular
- USB IEEE1394
- Switches
- Powercords Powerinlets
- DIN41612 Hardmetric
- MiniDIN
- Sockets / Strips Jumper
- Terminal Blocks
- Memory Card
- FFC / FPC

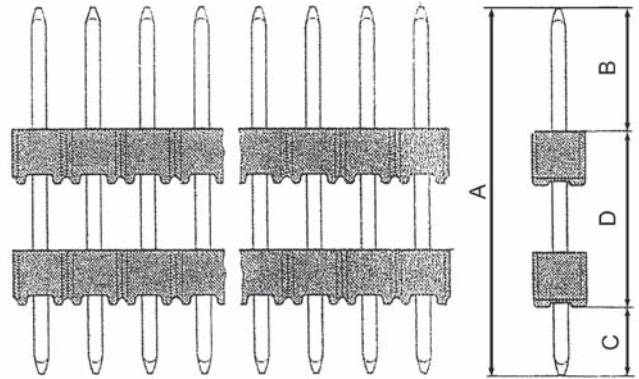
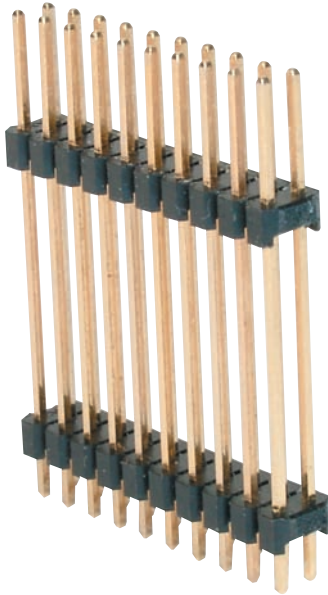

Länge / Length (mm)

- A - _____
- B - _____
- C - _____
- D - _____

Oberfläche / Contact plating

- Gold Flash / Gold flash
- Verzinkt / Tinned
- _____

Ausführung / Version

- 1 reihig / 1-row
- 2 reihig / 2-row
- 2.54mm Raster / Pitch
- 2.00mm Raster / Pitch

Polzahl / No. of contacts

- (2 - 40, 1 reihig / 1-row)
- (4 - 80, 2 reihig / 2-row)

Voraussichtlicher Jahresbedarf / Estimated annual use: _____

Cable
assemblies

D-Sub / Hoods
Centronics

Multiflex -
DIN41651

Modular

USB
IEEE1394

Switches

Powercords
Powerlets

DIN41612
Hardmetric

MiniDIN

Sockets / Strips
Jumper

Terminal Blocks

Memory Card

FFC / FPC

Isolierkörpermaterial

PBT, UL94V-0

Kontaktmaterial

Messing

Kontaktfläche

Ni, Au oder Sn

Kontaktwiderstand

20mΩ max

Isolationswiderstand

1000MΩ min

Strombelastbarkeit

1A

Betriebstemperatur

-40°C - +105°C

Betriebsspannung

250V AC

Prüfspannung

500V AC

Verpackung

Blisterverpackung

Insulator material

PBT, UL94V-0

Contact material

Brass

Plating

Ni, Au or Sn

Contact resistance

20mΩ max

Insulation resistance

1000MΩ min

Current rating

1A

Operating temperature

-40°C - +105°C

Operating voltage

250V AC

Test voltage

500V AC

Packing

Tray packing

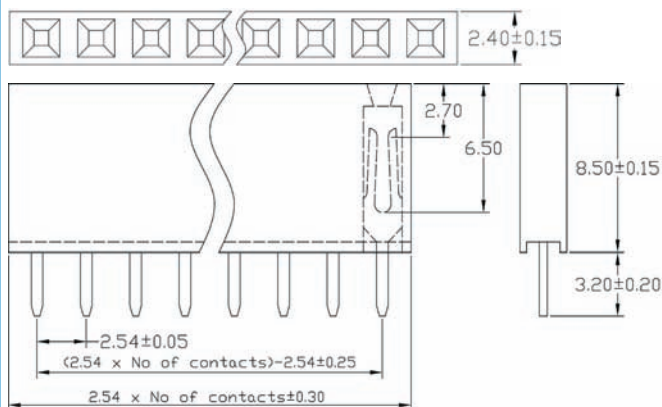
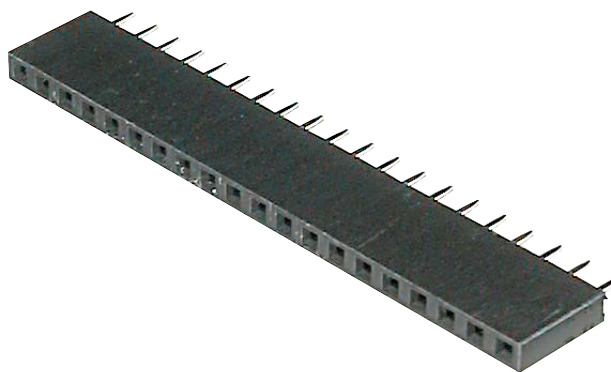

Bestellcode / Ordercode

Kontaktfläche

G - Gold Flash
 Z - Verzinkt

Polzahl

02 - 40

Stiftlänge

D - A = 3.2mm

Plating

G - Gold flash
 Z - Tinned

No. of contacts

02 - 40

Pin length

D - A = 3.2mm

A - BL254 - E G - x xx D

Bitte „x“ durch die geeignete Option ersetzen
 Please replace „x“ with appropriate option

- Cable assemblies
- D-Sub / Hoods Centronics
- Multiflex - DIN41651
- Modular
- USB IEEE1394
- Switches
- Powercords Powerlets
- DIN41612 Hardmetric
- MiniDIN
- Sockets / Strips Jumper
- Terminal Blocks
- Memory Card
- FFC / FPC

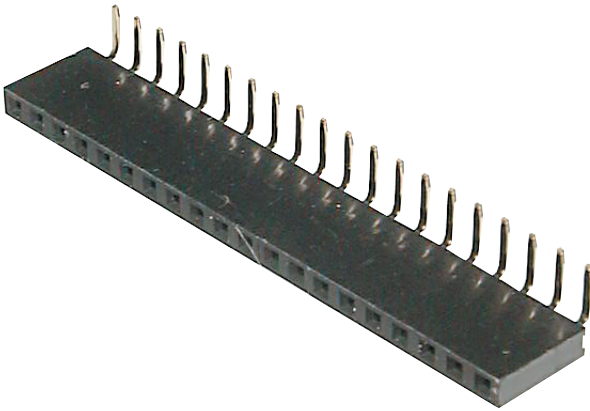

Isolierkörpermaterial

Nylon 6T, UL94V-0

Kontaktmaterial

Messing

Kontaktoberfläche

Ni, Au oder Sn

Kontaktwiderstand

20mΩ max

Isolationswiderstand

500MΩ min

Strombelastbarkeit

3A

Betriebstemperatur

-40°C - +105°C

Betriebsspannung

250V AC

Prüfspannung

500V AC

Verpackung

Blisterverpackung

Insulator material

Nylon 6T, UL94V-0

Contact material

Brass

Plating

Ni, Au or Sn

Contact resistance

20mΩ max

Insulation resistance

500MΩ min

Current rating

3A

Operating temperature

-40°C - +105°C

Operating voltage

250V AC

Test voltage

500V AC

Packing

Tray packing

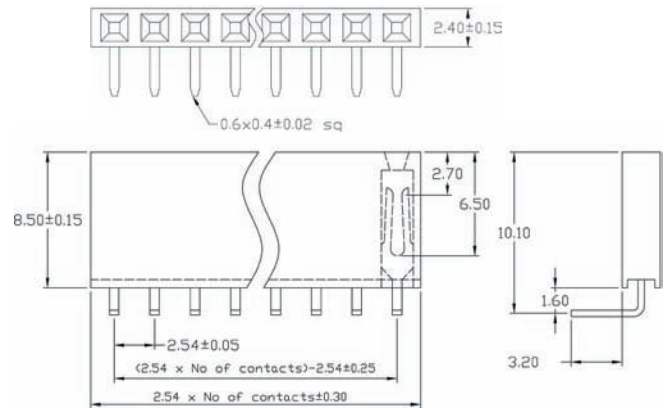

Bestellcode / Ordercode

Kontaktoberfläche

G - Gold Flash
Z - Verzinkt

Polzahl

02 - 40

Stiftlänge

D - A = 3.2mm

Plating

G - Gold flash
Z - Tinned

No. of contacts

02 - 40

Pin length

D - A = 3.20mm

A - BL254 - E A - x xx D

Bitte „x“ durch die geeignete Option ersetzen
Please replace „x“ with appropriate option

Isolierkörpermaterial

PBT, UL94V-0

Kontaktmaterial

Messing

Kontaktfläche

Ni, Au oder Sn

Kontaktwiderstand

20mΩ max

Isolationswiderstand

1000MΩ min

Strombelastbarkeit

3A

Betriebstemperatur

-40°C - +105°C

Betriebsspannung

250V AC

Prüfspannung

500V AC

Verpackung

Blisterverpackung

Insulator material

PBT, UL94V-0

Contact material

Brass

Plating

Ni, Au or Sn

Contact resistance

20mΩ max

Insulation resistance

1000MΩ min

Current rating

3A

Operating temperature

-40°C - +105°C

Operating voltage

250V AC

Test voltage

500V AC

Packing

Tray packing

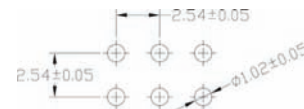
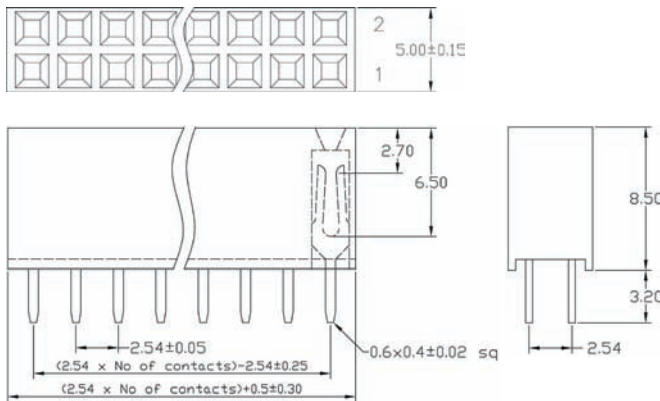
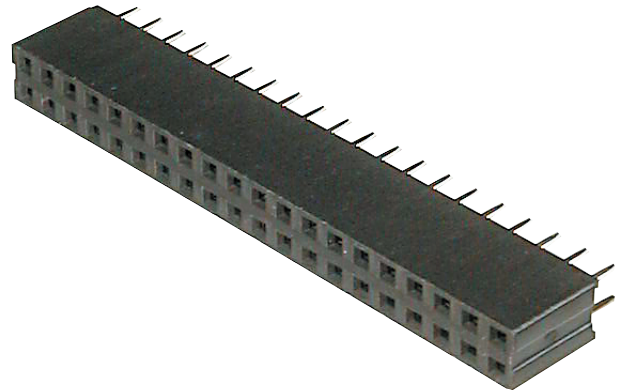

Bestellcode / Ordercode

Kontaktfläche

G - Gold Flash
 Z - Verzinkt

Polzahl

04 - 80

Stiftlänge

D - A = 3.2mm

Plating

G - Gold flash
 Z - Tinned

No. of contacts

04 - 80

Pin length

D - A = 3.20mm

A - BL254 - D G - x xx D

Bitte „x“ durch die geeignete Option ersetzen
 Please replace „x“ with appropriate option

Cable assemblies

D-Sub / Hoods Centronics

Multiflex - DIN41651

Modular

USB IEEE1394

Switches

Powercards Powerinlets

DIN41612 Hardmetric

MiniDIN

Sockets / Strips Jumper

Terminal Blocks

Memory Card

FFC / FPC

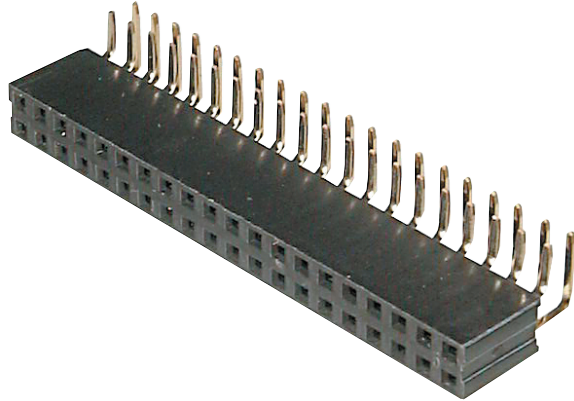

Isolierkörpermaterial
PBT, UL94V-0

Kontaktmaterial
Messing

Kontaktoberfläche
Ni, Au oder Sn

Kontaktwiderstand
20mΩ max

Isolationswiderstand
1000MΩ min

Strombelastbarkeit
3A

Betriebstemperatur
-40°C - +105°C

Betriebsspannung
250V AC

Prüfspannung
500V AC

Verpackung
Blisterverpackung

Insulator material
PBT, UL94V-0

Contact material
Brass

Plating
Ni, Au or Sn

Contact resistance
20mΩ max

Insulation resistance
1000MΩ min

Current rating
3A

Operating temperature
-40°C - +105°C

Operating voltage
250V AC

Test voltage
500V AC

Packing
Tray packing

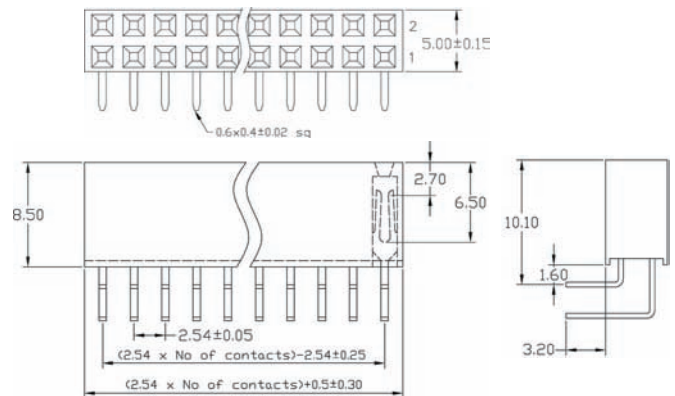

Bestellcode / Ordercode

Kontaktoberfläche

G - Gold Flash
Z - Verzinkt

Polzahl

04 - 80

Stiftlänge

D - A = 3.2mm

Plating

G - Gold flash
Z - Tinned

No. of contacts

04 - 80

Pin length

D - A = 3.20mm

A - BL254 - D A - x xx D

Bitte „x“ durch die geeignete Option ersetzen
Please replace „x“ with appropriate option

Isolierkörpermaterial

Nylon 6T, UL94V-0

Kontaktmaterial

Phosphorbronze

Kontaktfläche

Ni, Au oder Sn

Kontaktwiderstand

20mΩ max

Isolationswiderstand

5000MΩ min

Strombelastbarkeit

1A

Betriebstemperatur

-40°C - +105°C

Betriebsspannung

125V AC

Prüfspannung

500V AC

Verpackung

Blisterverpackung

Insulator material

PBT, UL94V-0

Contact material

Phosphor bronze

Plating

Ni, Au or Sn

Contact resistance

20mΩ max

Insulation resistance

5000MΩ min

Current rating

1A

Operating temperature

-40°C - +105°C

Operating voltage

125V AC

Test voltage

500V AC

Packing

Tray packing

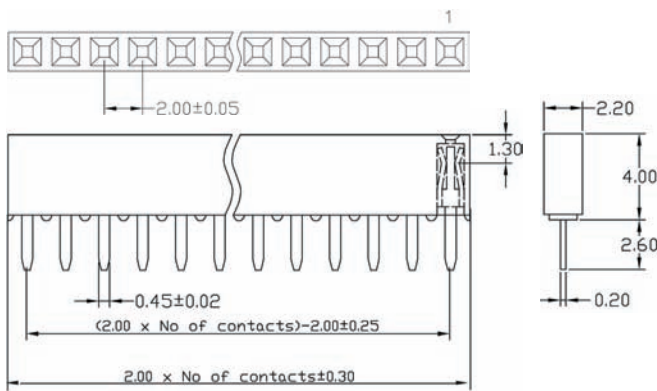
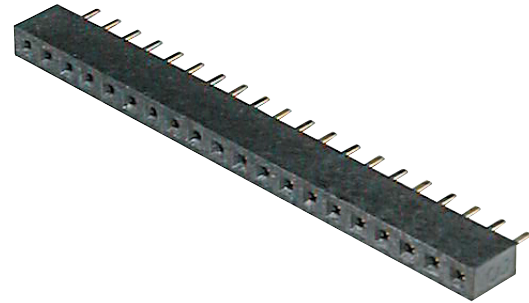

Bestellcode / Ordercode

Kontaktfläche

G - Gold Flash
 Z - Verzinkt

Polzahl

03 - 40

Stiftlänge

D - A = 2.6mm

Plating

G - Gold flash
 Z - Tinned

No. of contacts

03 - 40

Pin length

D - A = 2.6mm

A - BL254 - E G - x xx D

Bitte „x“ durch die geeignete Option ersetzen
 Please replace „x“ with appropriate option

Cable assemblies

D-Sub / Hoods Centronics

Multiflex - DIN41651

Modular

USB IEEE1394

Switches

Powercords Powerinlets

DIN41612 Hardmetric

MiniDIN

Sockets / Strips Jumper

Terminal Blocks

Memory Card

FFC / FPC

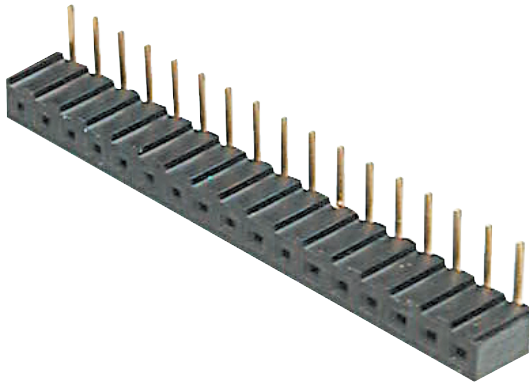

Isolierkörpermaterial

Nylon-6T, UL94V-0

Kontaktmaterial

Phosphorbronze

Kontaktfläche

Ni, Au oder Sn

Kontaktwiderstand

20mΩ max

Isolationswiderstand

5000MΩ min

Strombelastbarkeit

1A

Betriebstemperatur

-40°C - +105°C

Betriebsspannung

125V AC

Prüfspannung

500V AC

Verpackung

Blisterverpackung

Insulator material

Nylon-6T, UL94V-0

Contact material

Phosphor bronze

Plating

Ni, Au or Sn

Contact resistance

20mΩ max

Insulation resistance

5000MΩ min

Current rating

1A

Operating temperature

-40°C - +105°C

Operating voltage

125V AC

Test voltage

500V AC

Packing

Tray packing

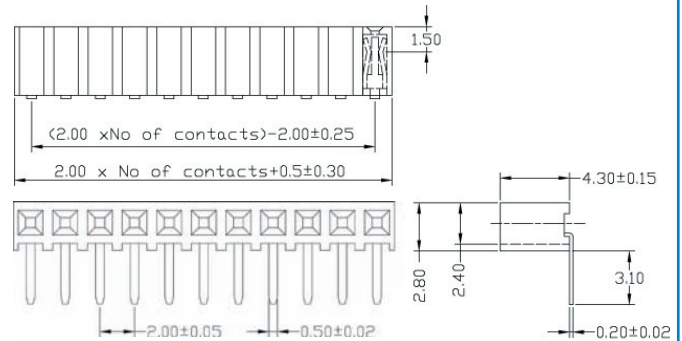

Bestellcode / Ordercode

Kontaktfläche

- G - Gold Flash
- Z - Verzinkt

Polzahl

03 - 25

Stiftlänge

D - A = 3.1mm

Plating

- G - Gold flash
- Z - Tinned

No of contacts

03 - 25

Pin length

D - A = 3.1mm

A - BL200 - E A - x xx D

Bitte „x“ durch die geeignete Option ersetzen
Please replace „x“ with appropriate option

Isolierkörpermaterial

Nylon-6T, UL94V-0

Kontaktmaterial

Phosphorbronze

Kontaktfläche

Ni, Au oder Sn

Kontaktwiderstand

20mΩ max

Isolationswiderstand

5000MΩ min

Strombelastbarkeit

1A

Betriebstemperatur

-40°C - +105°C

Betriebsspannung

125V AC

Prüfspannung

500V AC

Verpackung

Blisterverpackung

Insulator material

Nylon-6T, UL94V-0

Contact material

phosphor bronze

Plating

Ni, Au or Sn

Contact resistance

20mΩ max

Insulation resistance

5000MΩ min

Current rating

1A

Operating temperature

-40°C - +105°C

Operating voltage

125V AC

Test voltage

500V AC

Packing

tray packing

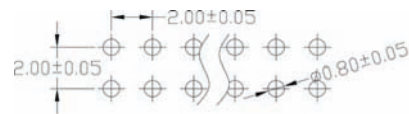
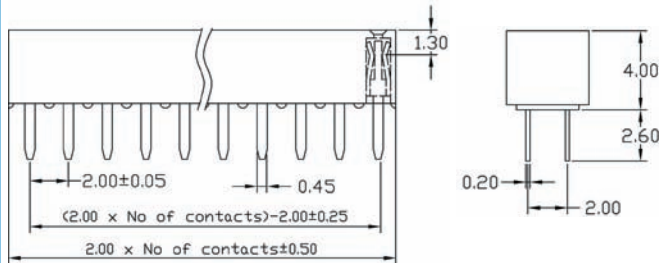
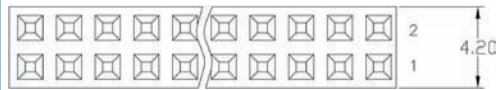
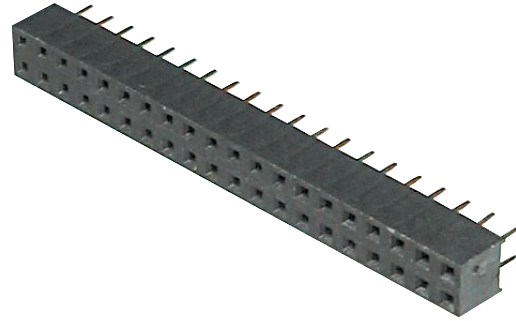

Bestellcode / Ordercode

Kontaktfläche

G - Gold Flash
 Z - Verzinkt

Polzahl

04 - 80

Stiftlänge

D - A = 2.6mm

Plating

G - Gold flash
 Z - Tinned

No. of contacts

04 - 80

Pin length

D - A = 2.6mm

A - BL200 - D G - x xx D

Bitte „x“ durch die geeignete Option ersetzen
 Please replace „x“ with appropriate option

- Cable assemblies
- D-Sub / Hoods Centronics
- Multiflex - DIN41651
- Modular
- USB IEEE1394
- Switches
- Powercords Powerinlets
- DIN41612 Hardmetric
- MiniDIN
- Sockets / Strips Jumper
- Terminal Blocks
- Memory Card
- FFC / FPC

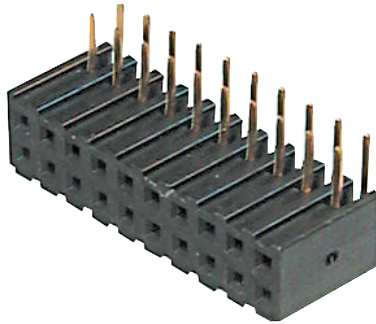

Isolierkörpermaterial

Nylon 6T, UL94V-0

Kontaktmaterial

Messing

Kontaktoberfläche

Ni, Au oder Sn

Kontaktwiderstand

20mΩ max

Isolationswiderstand

500MΩ min

Strombelastbarkeit

3A

Betriebstemperatur

-40°C - +105°C

Betriebsspannung

250V AC

Prüfspannung

500V AC

Verpackung

Blisterverpackung

Insulator material

Nylon 6T, UL94V-0

Contact material

Brass

Plating

Ni, Au or Sn

Contact resistance

20mΩ max

Insulation resistance

500MΩ min

Current rating

3A

Operating temperature

-40°C - +105°C

Operating voltage

250V AC

Test voltage

500V AC

Packing

Tray packing

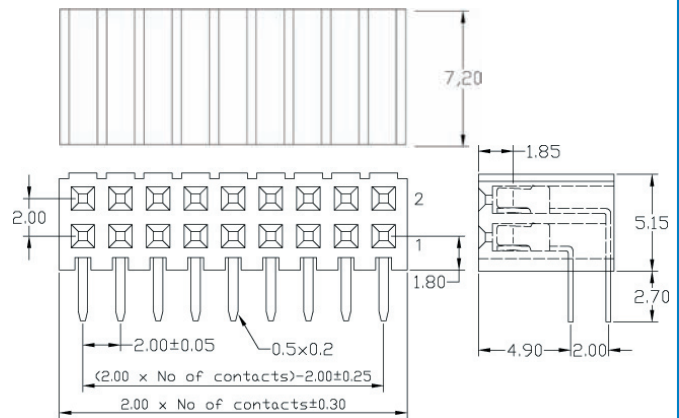
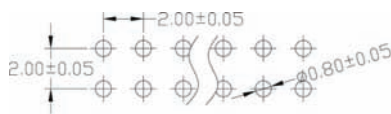

Bestellcode / Ordercode

Kontaktoberfläche

- G - Gold Flash
- Z - Verzinkt

Polzahl

06 - 80

Stiftlänge

D - A = 2.7mm

Plating

- G - Gold flash
- Z - Tinned

No. of contacts

06 - 80

Pin length

D - A = 2.7mm

A - BL200 - D A - x xx D

Bitte „x“ durch die geeignete Option ersetzen
Please replace „x“ with appropriate option

Isolierkörpermaterial
Nylon-6T, UL94V-0

Kontaktmaterial
Phosphorbronze

Kontaktfläche
Ni, Au oder Sn

Kontaktwiderstand
20mΩ max

Isolationswiderstand
5000MΩ min

Strombelastbarkeit
1A

Betriebstemperatur
-40°C - +105°C

Betriebsspannung
125V AC

Prüfspannung
500V AC

Verpackung
Blisterverpackung

Insulator material
Nylon-6T, UL94V-0

Contact material
Phosphor bronze

Plating
Ni, Au or Sn

Contact resistance
20mΩ max

Insulation resistance
5000MΩ min

Current rating
1A

Operating temperature
-40°C - +105°C

Operating voltage
125V AC

Test voltage
500V AC

Packing
Tray packing

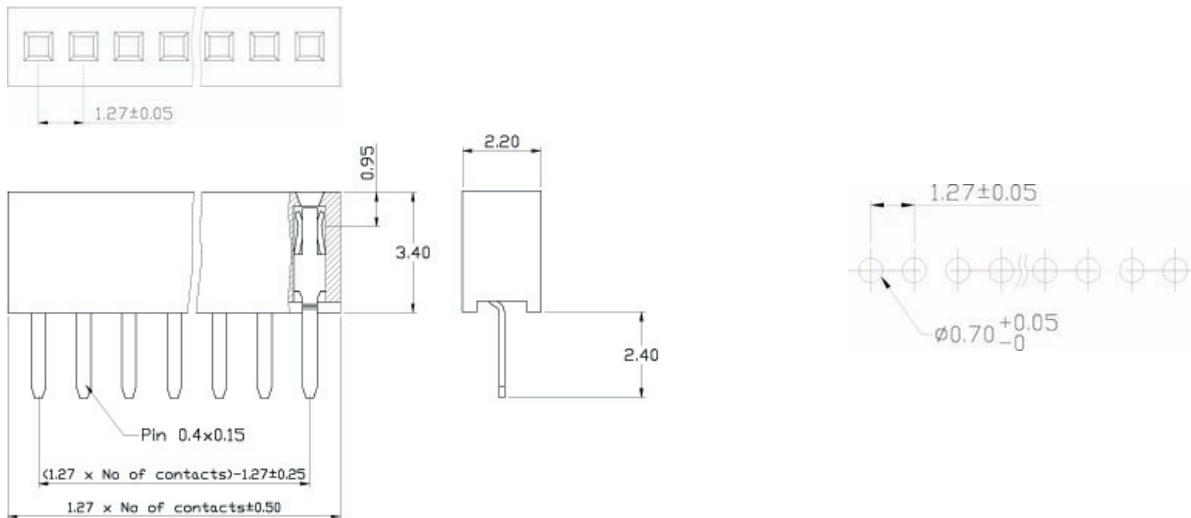
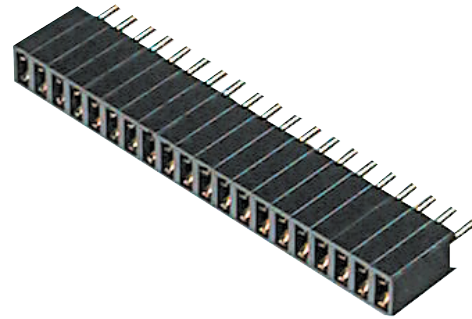

Bestellcode / Ordercode

Kontaktfläche

G - Gold Flash
Z - Verzinkt

Polzahl

03 - 40

Stiftlänge

D - A = 2.4mm

Plating

G - Gold flash
Z - Tinned

No. of contacts

03 - 40

Pin length

D - A = 2.4mm

A - BL127 - E G - x xx D

Bitte „x“ durch die geeignete Option ersetzen
 Please replace „x“ with appropriate option

- Cable assemblies
- D-Sub / Hoods Centronics
- Multiflex - DIN41651
- Modular
- USB IEEE1394
- Switches
- Powercords Powernets
- DIN41612 Hardmetric
- MiniDIN
- Sockets / Strips Jumper
- Terminal Blocks
- Memory Card
- FFC / FPC

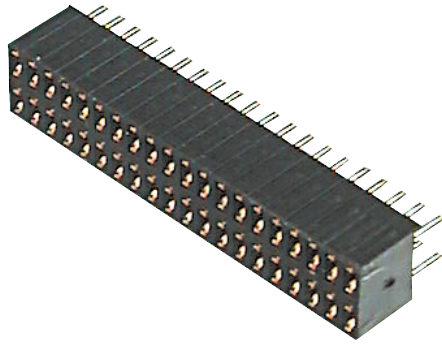

Isolierkörpermaterial
Nylon 6T, UL94V-0

Kontaktmaterial
Phosphorbronze

Kontaktoberfläche
Ni, Au oder Sn

Kontaktwiderstand
20mΩ max

Isolationswiderstand
5000MΩ min

Strombelastbarkeit
1A

Betriebstemperatur
-40°C - +105°C

Betriebsspannung
125V AC

Prüfspannung
500V AC

Verpackung
Blisterverpackung

Insulator material
Nylon 6T, UL94V-0

Contact material
Phosphor bronze

Plating
Ni, Au or Sn

Contact resistance
20mΩ max

Insulation resistance
5000MΩ min

Current rating
1A

Operating temperature
-40°C - +105°C

Operating voltage
125V AC

Test voltage
500V AC

Packing
Tray packing

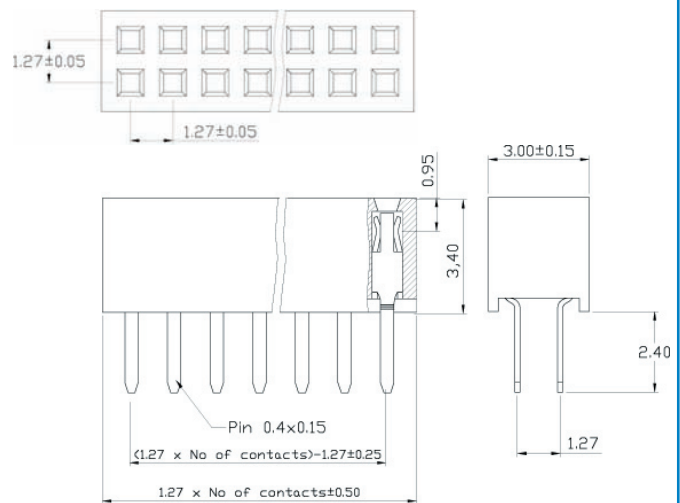
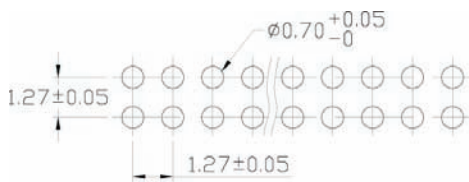

Bestellcode / Ordercode

Kontaktfläche

G - Gold Flash
Z - Verzinkt

Polzahl

06 - 80

Stiftlänge

D - A = 2.4mm

Plating

G - Gold flash
Z - Tinned

No. of contacts

06 - 80

Pin length

D - A = 2.4mm

A - BL127 - D G - x xx D

Bitte „x“ durch die geeignete Option ersetzen
Please replace „x“ with appropriate option

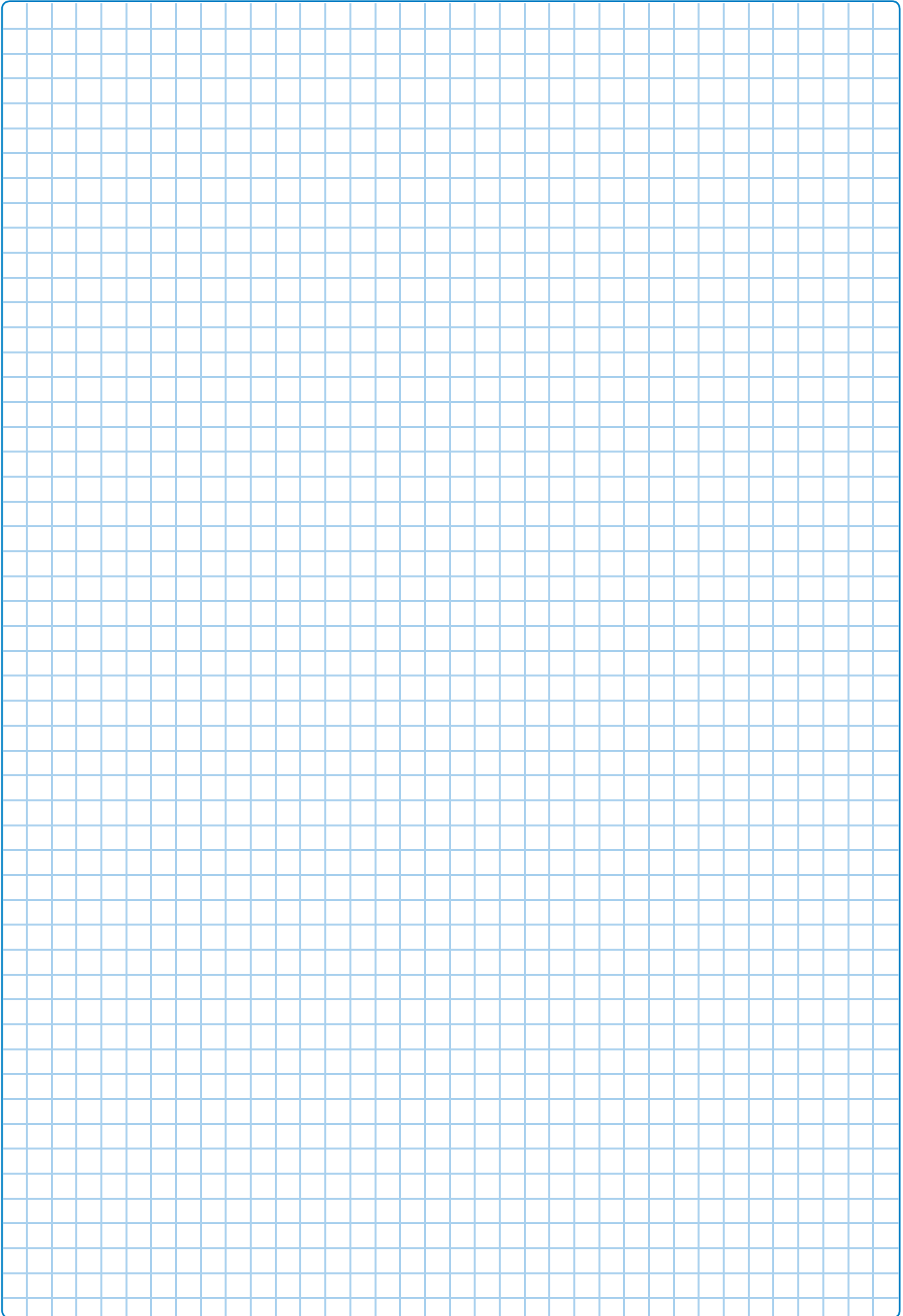

FFC / FPC

Memory Card

Terminal Blocks

Sockets / Strips
Jumper

MiniDIN

DIN41612
Hardmetric

Powercords
Powerinlets

Switches

USB
IEEE1394

Modular

Multiflex -
DIN41651

D-Sub / Hoods
Centronics

Cable
assemblies