



Power line chokes

1.8 μ H / 1 MHz, 21 A, +125 °C

Ordering code: B82116B1224A010

Date: 2016-07-07

Version: 01

Rod core choke

Rated current: 21 A / +125 °C

Rated inductance: 1.8 μ H / 1 MHz

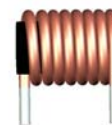
Construction

- Rod core choke
- Ferrite core
- Single layer winding
- Core and winding glued

Features

- High resonance frequency
- Enameled wire in accordance to EN 60317-13, Grade 1
- Wire class 200, UL listed
- Suitable for wave soldering or welding
- RoHS compatible

Applications

- EMC choke

Terminals

- Ends of winding wire
- Pins hot dip tinned with Sn99Cu

Delivery mode

- Trays in cardboard box

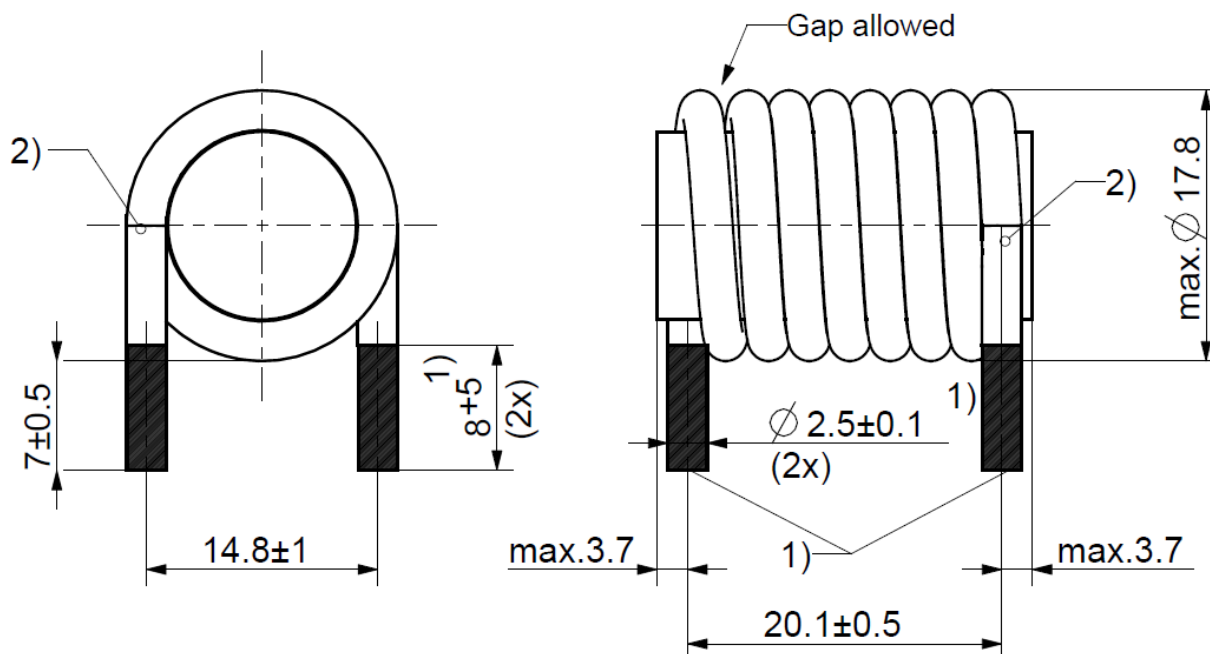
Dimensional drawing

- 1) Solderable tinned with Sn99Cu.
Bare copper wire above the tinned area is permissible.
- 2) At this position a little press mark on the first turn appears caused by wire holder of winding machine.
An additional hole in the wire coating may appear.

Longitudinal axis of core is not central to the winding.

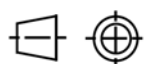

All dimensions in mm
ISO 2768-cL

Tolerance
ISO 8015

Dimensions
ISO 14405

Rod core choke
Technical data and measuring conditions

Rated temperature T_R	+125 °C
Rated current I_R	21 A Referred to DC current and rated temperature.
Rated inductance L_R	1.8 μ H / 1 MHz Measured with Agilent 4284A, 1 mA, at +20 °C
Inductance $L_{(1\text{ kHz})}$ (only for information)	2.3 μ H / 1kHz Measured with Agilent 4284A, 1 mA, at +20 °C
Inductance tolerance	\pm 20% at +20 °C
Inductance decrease $\Delta L/L_0$	\leq 10% at DC magnetic bias with 110 A, +20 °C
DC resistance R_{typ}	1.4 m Ω typical value, measured at +20 °C
Operating temperature range	-40°C ... +150°C
Weight	Approx. 29 g
Wire insulation	Leaks in insulation of wire in accordance to EN 60317-0-1 allowed
Ferrite core surface irregularities	The standard IEC 60424-4 is the basis for the visual inspection of surface irregularities. These surface irregularities have no impact regarding function, manufacture ability and reliability of the component. No further spalling of core material permissible.

Rod core choke

Impedance |Z| versus frequency
(Typical values measured at +20 °C)

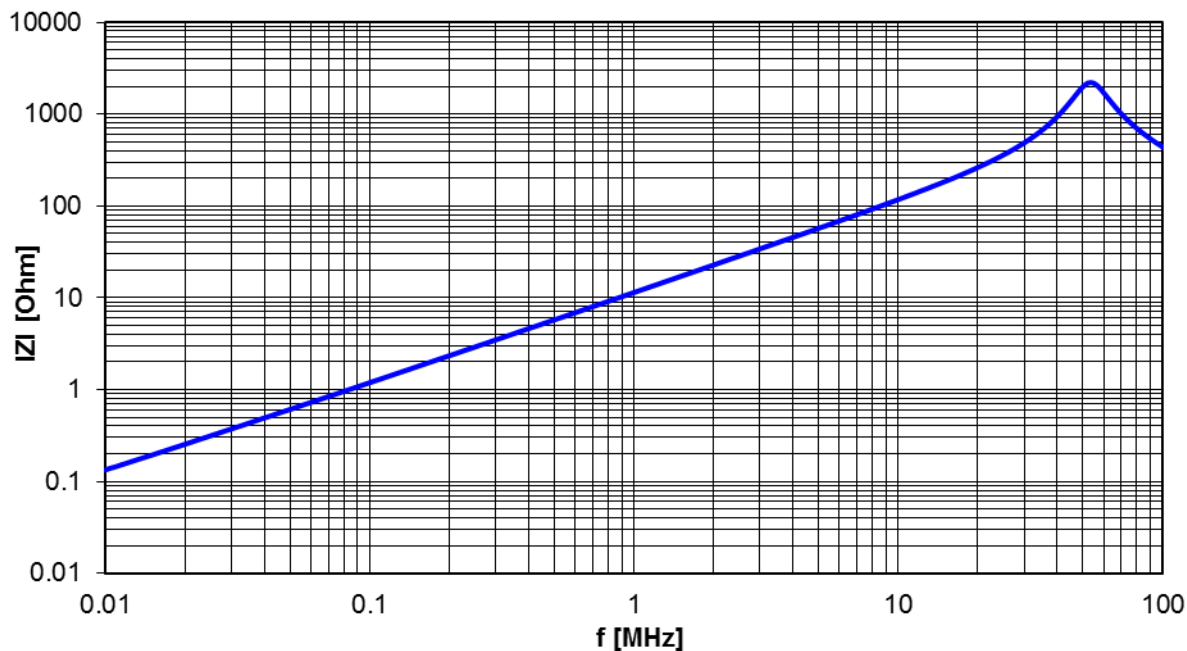

Inductance Ls versus frequency
(Typical values measured at +20 °C)

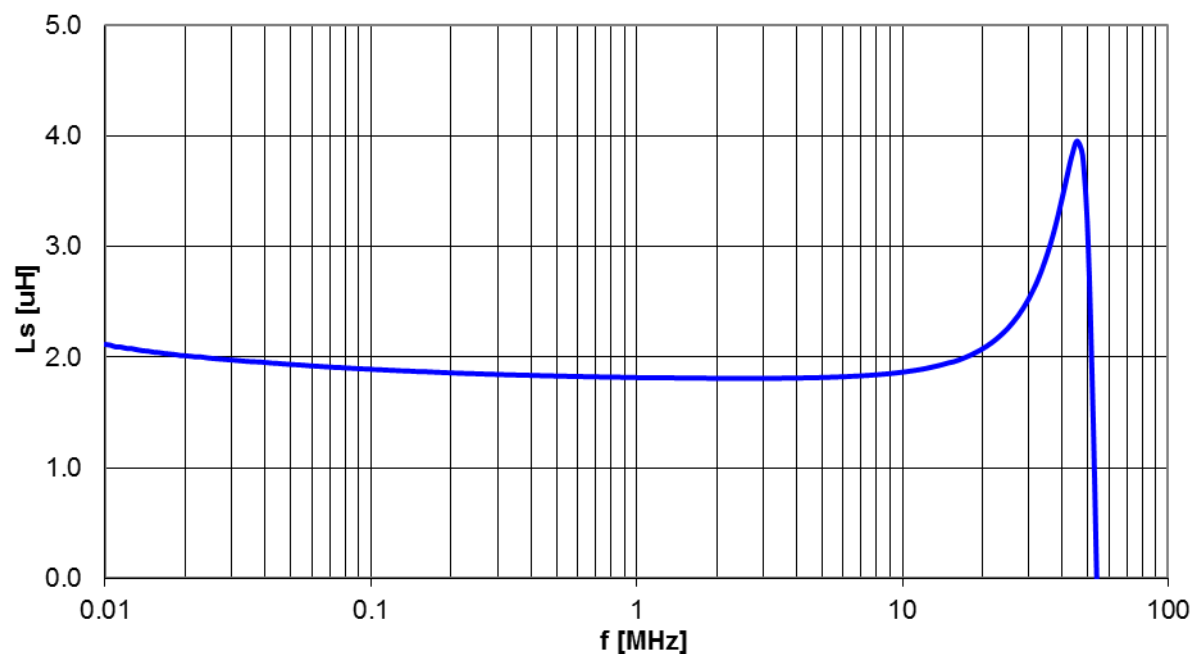

Rod core choke

Inductance L/L_0 versus DC bias current I

(Typical values measured at +20 °C, +125 °C Measured with DC BIAS method)

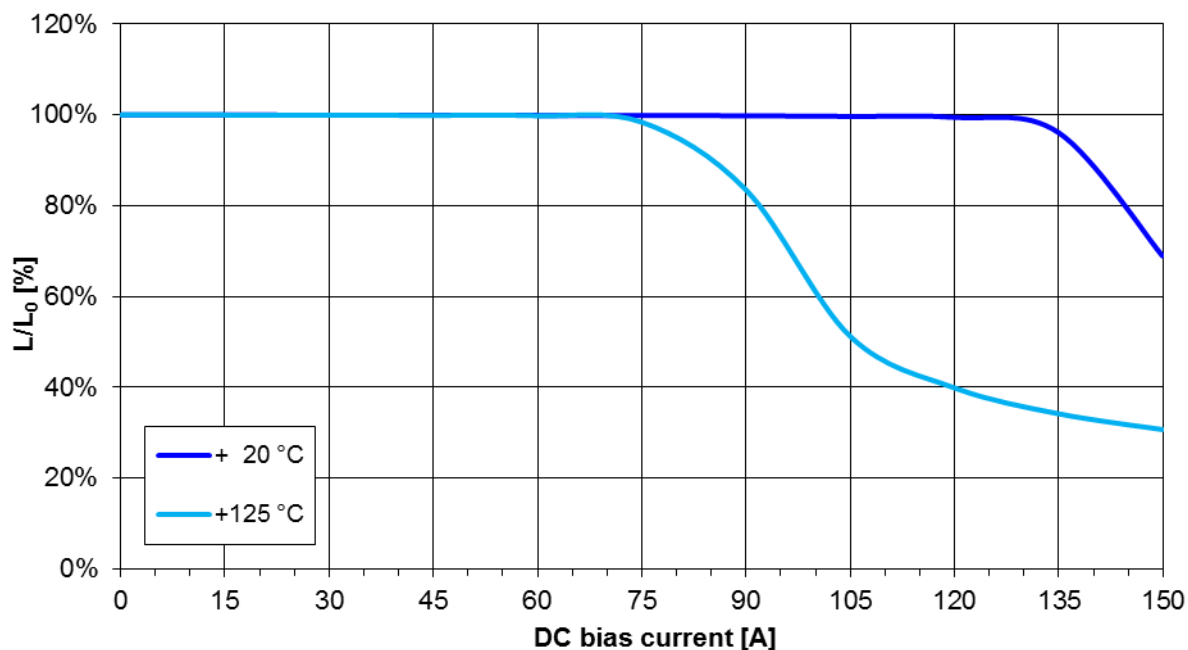

Current derating I_{op}/I_R versus ambient temperature T_A

(rated temperature $T_R = +125$ °C)

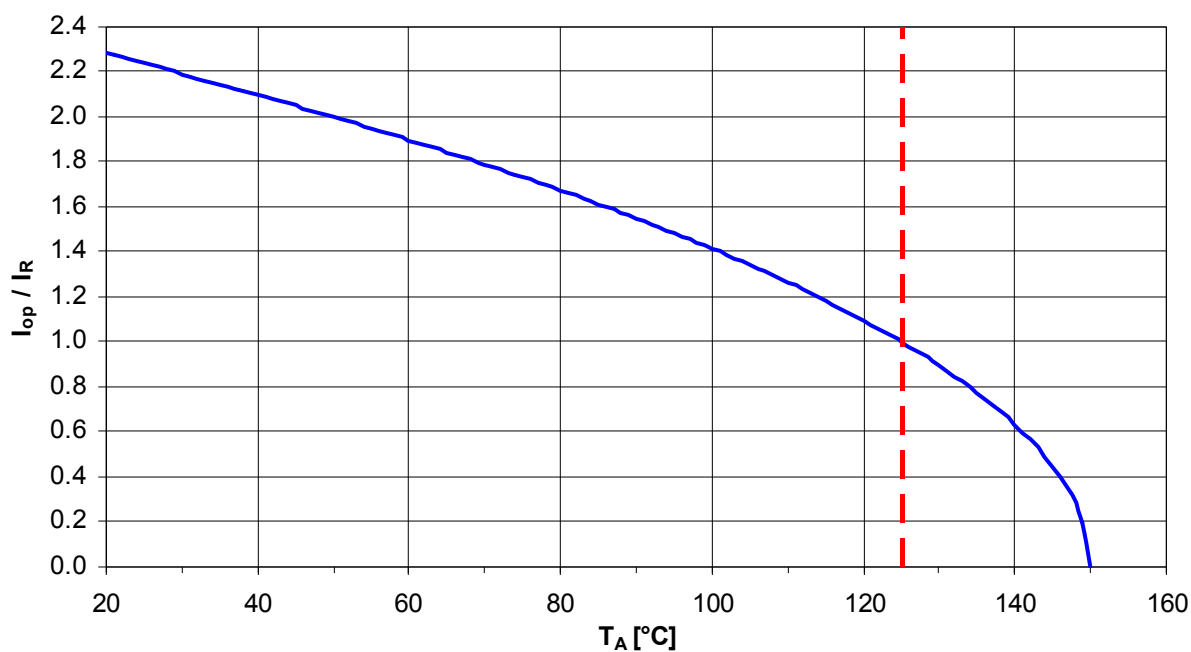

Rod core choke
Cautions and warnings

- Please note the recommendations in our Inductors data book (latest edition) and in the data sheets.
 - Particular attention should be paid to the derating curves given there. Derating must be applied in case the ambient temperature in the application exceeds the rated temperature of the component.
 - Ensure the operation temperature (which is the sum of the ambient temperature and the temperature rise caused by losses / self-heating) of the component in the application does not exceed the maximum value specified in operating temperature range.
 - The soldering conditions should also be observed. Temperatures quoted in relation to wave soldering refer to the pin, not to the housing.

- If the components are to be washed varnished, it is necessary to check whether the washing varnish agent that is used has a negative effect on the wire insulation, any plastics that are used, or on glued joints. In particular, it is possible for washing varnish agent residues to have a negative effect in the long-term on wire insulation.
 Washing processes may damage the product due to the possible static or cyclic mechanical loads (e.g. ultrasonic cleaning). They may cause cracks to develop on the product and its parts, which might lead to reduced reliability or lifetime.

- The following points must be observed if the components are potted in customer application:
 - Many potting materials shrink as they harden. They therefore exert a pressure on the plastic housing or core. This pressure can have a deleterious effect on electrical properties and, in extreme cases, can damage the core or plastic housing mechanically;
 - It is necessary to check whether the potting material used attacks or destroys the wire insulation, plastics or glue;
 - The effect of the potting material can change the high-frequency behaviour of the components.

- Ferrites are sensitive to direct impact. This can cause the core material to flake, or lead to breakage of the core.

- Even for customer-specific products, conclusive validation of the components in the circuit can only be carried out by the customer.

Display of ordering codes for EPCOS products

The ordering code for one and the same EPCOS product can be represented differently in data sheets, data books, other publications, on the EPCOS website, or in order-related documents such as shipping notes, order confirmations and product labels. **The varying representations of the ordering codes are due to different processes employed and do not affect the specifications of the respective products.** Detailed information can be found on the Internet under www.epcos.com/orderingcodes

Important notes

The following applies to all products named in this publication:

1. Some parts of this publication contain **statements about the suitability of our products for certain areas of application**. These statements are based on our knowledge of typical requirements that are often placed on our products in the areas of application concerned. We nevertheless expressly point out **that such statements cannot be regarded as binding statements about the suitability of our products for a particular customer application**. As a rule we are either unfamiliar with individual customer applications or less familiar with them than the customers themselves. For these reasons, it is always ultimately incumbent on the customer to check and decide whether a product with the properties described in the product specification is suitable for use in a particular customer application.
2. We also point out that **in individual cases, a malfunction of electronic components or failure before the end of their usual service life cannot be completely ruled out in the current state of the art, even if they are operated as specified**. In customer applications requiring a very high level of operational safety and especially in customer applications in which the malfunction or failure of an electronic component could endanger human life or health (e.g. in accident prevention or life-saving systems), it must therefore be ensured by means of suitable design of the customer application or other action taken by the customer (e.g. installation of protective circuitry or redundancy) that no injury or damage is sustained by third parties in the event of malfunction or failure of an electronic component.
3. **The warnings, cautions and product-specific notes must be observed.**
4. In order to satisfy certain technical requirements, **some of the products described in this publication may contain substances subject to restrictions in certain jurisdictions (e.g. because they are classed as hazardous)**. Useful information on this will be found in our Material Data Sheets on the Internet (www.tdk-electronics.tdk.com/material). Should you have any more detailed questions, please contact our sales offices.
5. We constantly strive to improve our products. Consequently, **the products described in this publication may change from time to time**. The same is true of the corresponding product specifications. Please check therefore to what extent product descriptions and specifications contained in this publication are still applicable before or when you place an order.

We also **reserve the right to discontinue production and delivery of products**. Consequently, we cannot guarantee that all products named in this publication will always be available. The aforementioned does not apply in the case of individual agreements deviating from the foregoing for customer-specific products.
6. Unless otherwise agreed in individual contracts, **all orders are subject to our General Terms and Conditions of Supply**.
7. **Our manufacturing sites serving the automotive business apply the IATF 16949 standard**. The IATF certifications confirm our compliance with requirements regarding the quality management system in the automotive industry. Referring to customer requirements and customer specific requirements ("CSR") TDK always has and will continue to have the policy of respecting individual agreements. Even if IATF 16949 may appear to support the acceptance of unilateral requirements, we hereby like to emphasize that **only requirements mutually agreed upon can and will be implemented in our Quality Management System**. For clarification purposes we like to point out that obligations from IATF 16949 shall only become legally binding if individually agreed upon.
8. The trade names EPCOS, CeraCharge, CeraDiode, CeraLink, CeraPad, CeraPlas, CSMP, CTVS, DeltaCap, DigiSiMic, ExoCore, FilterCap, FormFit, LeaXield, MiniBlue, MiniCell, MKD, MKK, MotorCap, PCC, PhaseCap, PhaseCube, PhaseMod, PhiCap, PowerHap, PQSine, PQvar, SIFERRIT, SIFI, SIKOREL, SilverCap, SIMDAD, SiMic, SIMID, SineFormer, SIOV, ThermoFuse, WindCap are **trademarks registered or pending** in Europe and in other countries. Further information will be found on the Internet at www.tdk-electronics.tdk.com/trademarks.

Release 2018-10

SZ MAG PD T

2016-07-07