

4

3

2

1

THIS DRAWING IS UNPUBLISHED.

RELEASED FOR PUBLICATION

2008

© COPYRIGHT 2008

BY -

ALL RIGHTS RESERVED.

REVISIONS

P	LTR	DESCRIPTION	DATE	DWN	APVD
	BA1	ECR-17-011125	01AUG2017	RK	TN

FOR FURTHER INFORMATION SEE DATA SHEET FOR
SERIES TYPE SBC(SQUARE CERAMIC), HIGH POWER RESISTORS

50.0±1.5

Ø0.80±0.02

1.6

2.6

10.0±0.5

9.0±0.5

70±3

30±3

RoHS Compliant

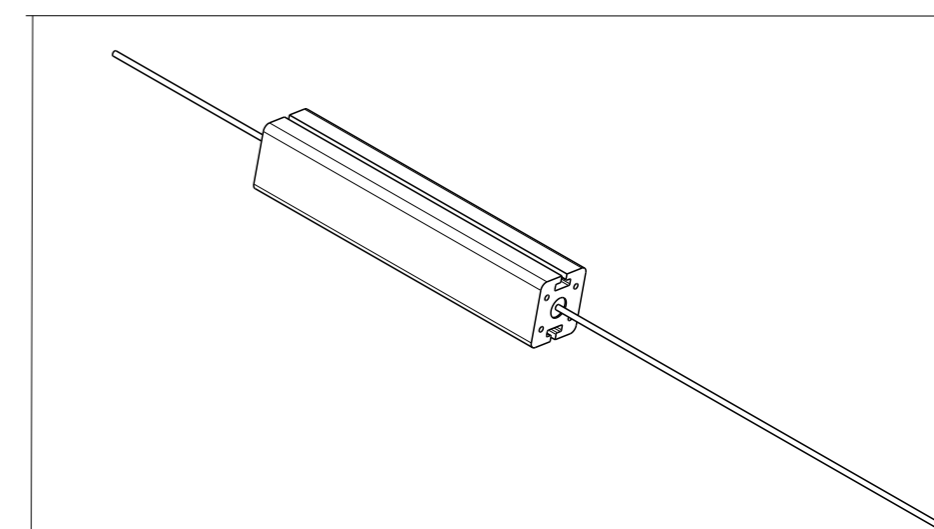

THIS DRAWING IS A CONTROLLED DOCUMENT.

DWN 28 JULY 2010
PARUSURAM.ICHK 28 JULY 2010
STEPHEN.PAPVD 28 JULY 2010
STEPHEN.P

PRODUCT SPEC

APPLICATION SPEC

WEIGHT 10g

CUSTOMER DRAWING



TE Connectivity

NAME
HIGH POWER RESISTOR TYPE
SBC (SQUARE CERAMIC) SERIES SBCHE11

SIZE CAGE CODE DRAWING NO RESTRICTED TO

A3 00779 C-1623728 -

SCALE 4:1 SHEET 1 OF 1 REV BA1

DIMENSIONS:

mm

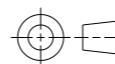
TOLERANCES UNLESS
OTHERWISE SPECIFIED:

0 PLC	±0.2
1 PLC	±0.1
2 PLC	±
3 PLC	±
4 PLC	±
ANGLES	±5°

MATERIAL

-

FINISH

-

1470-19 (3/13)

Mouser Electronics

Authorized Distributor

Click to View Pricing, Inventory, Delivery & Lifecycle Information:

[TE Connectivity:](#)

[2-1623728-1](#)