

YASMEEN-70-M

~26° wide beam. Assembly with holder C (LEDiL HEKLA) and B (BJB and B+W). Black and white versions.

SPECIFICATION:

Dimensions	Ø 70.0 mm
Height	37.7 mm
Fastening	socket
ROHS compliant	yes ⓘ



MATERIALS:

Component	Type	Material	Colour	Finish
YASMEEN-70-M	Single lens	PMMA	clear	
YASMEEN-70-HLD2-C	Holder C	PC	black	
YASMEEN-70-HLD2-B	Holder B	PC	black	
YASMEEN-70-HLD2-C-WHT	Holder C	PC	white	
YASMEEN-70-HLD2-B-WHT	Holder B	PC	white	

ORDERING INFORMATION:

Component	Qty in box	MOQ	MPQ	Box weight (kg)
C17239_YASMEEN-70-M	105	105	15	8.4
Assembly				
CP18783_YASMEEN-70-M-B2-WHT	105	105	15	9.9
CP18776_YASMEEN-70-M-C2-WHT	105	105	15	9.8
CP18769_YASMEEN-70-M-B2	105	105	15	9.9
CP18762_YASMEEN-70-M-C2	105	105	15	9.8

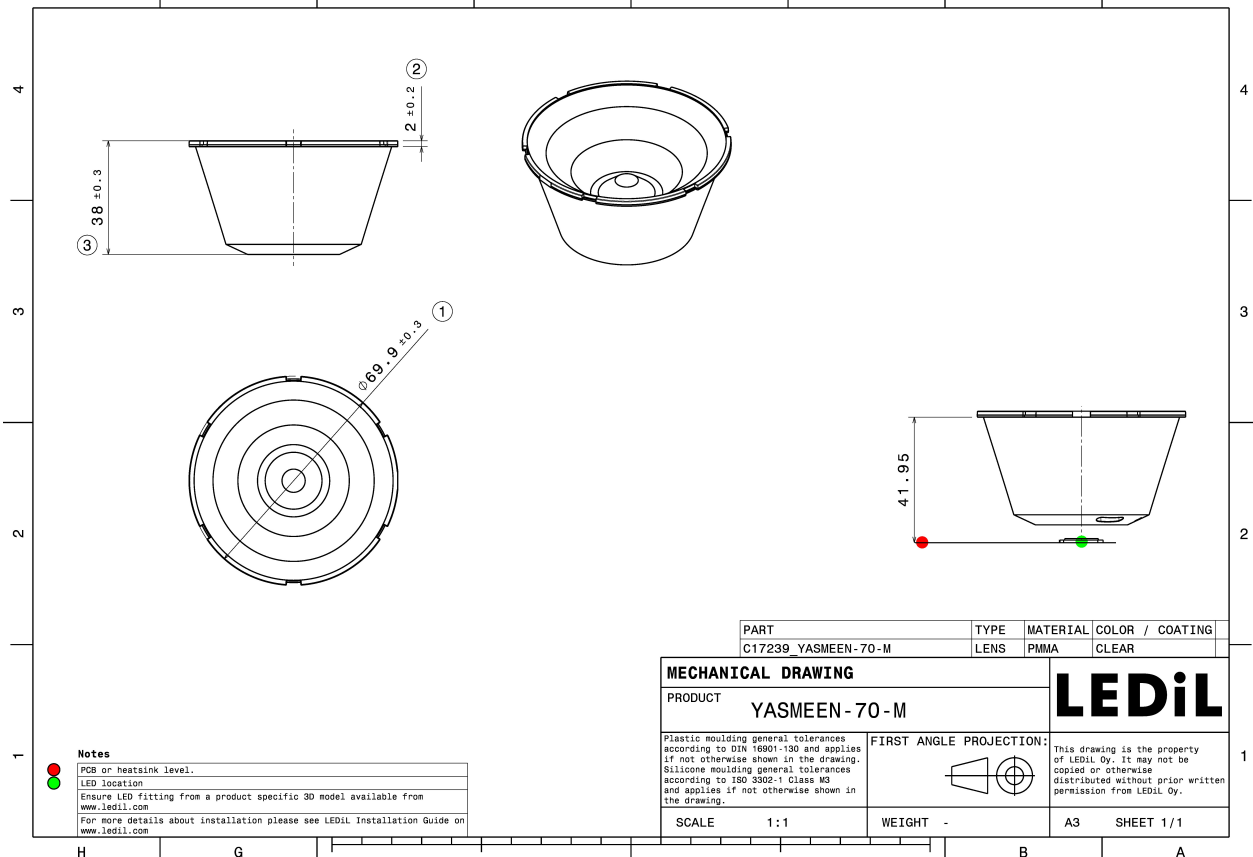
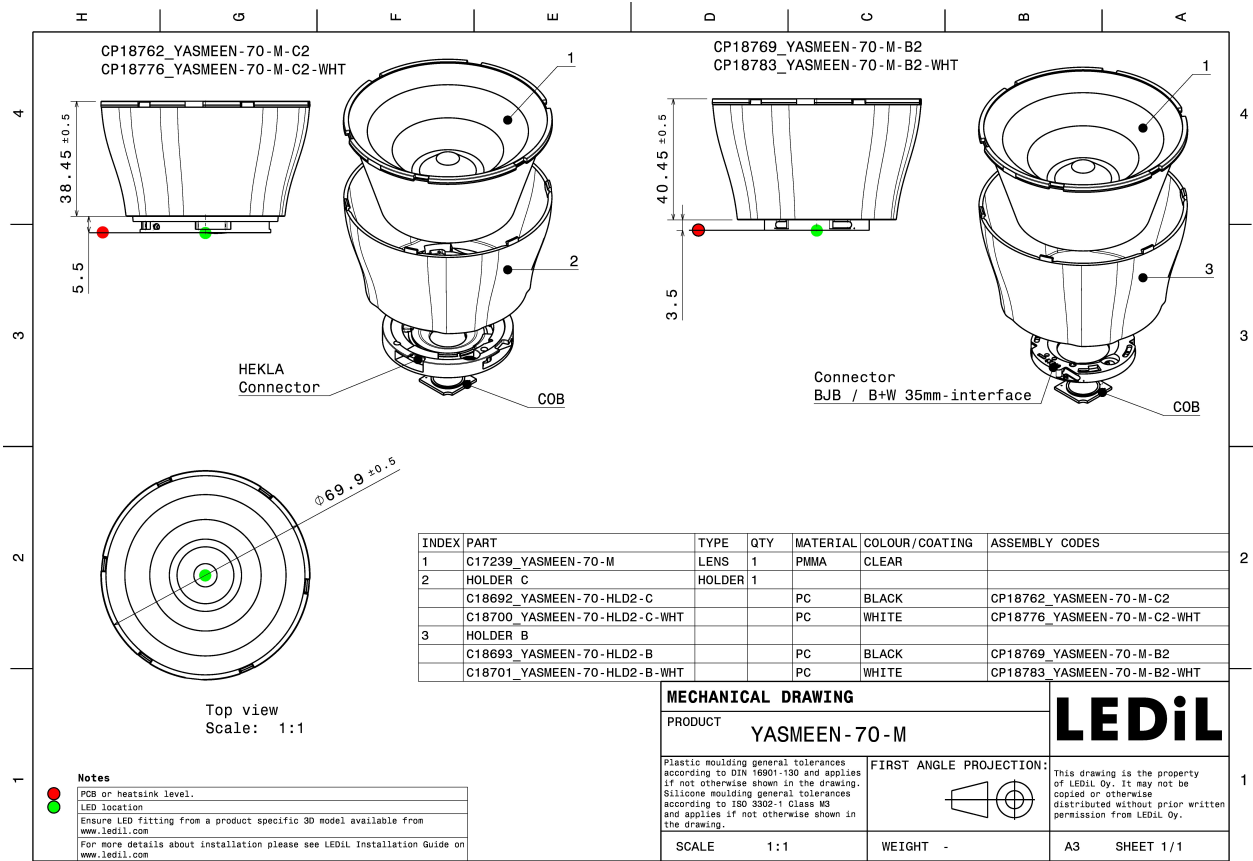

See also our general installation guide: www.ledil.com/installation_guide

OPTICAL RESULTS (MEASURED):

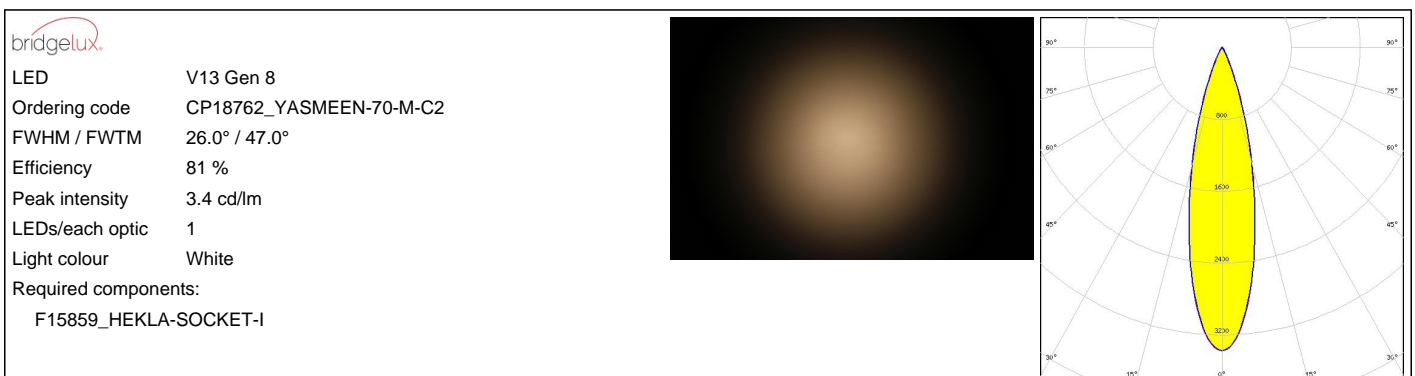
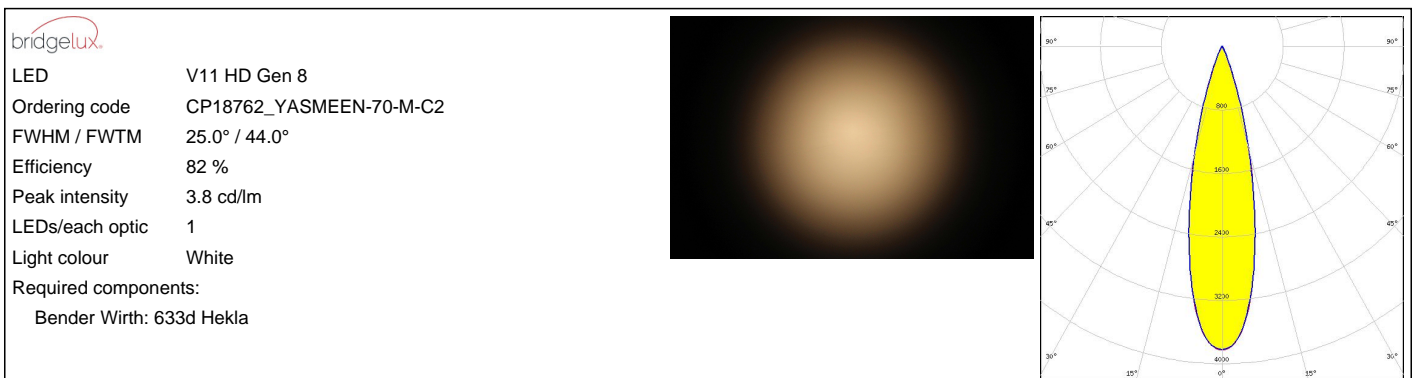
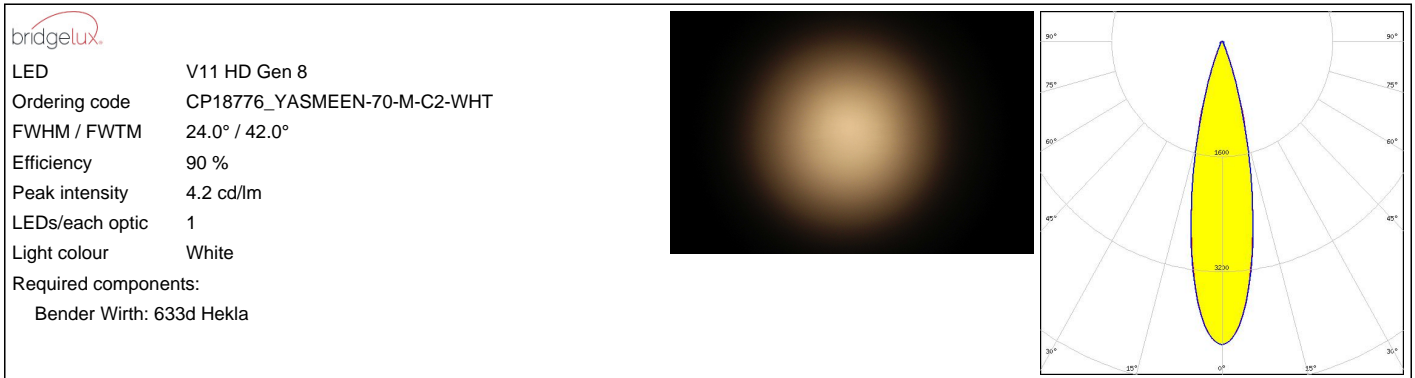

OPTICAL RESULTS (MEASURED):

bridgelux

LED V8 Gen 8
 Ordering code CP18762_YASMEEN-70-M-C2
 FWHM / FWTM 27.0° / 43.0°
 Efficiency 85 %
 Peak intensity 3.7 cd/lm
 LEDs/each optic 1
 Light colour White
 Required components:
 F15253_HEKLA-SOCKET-A

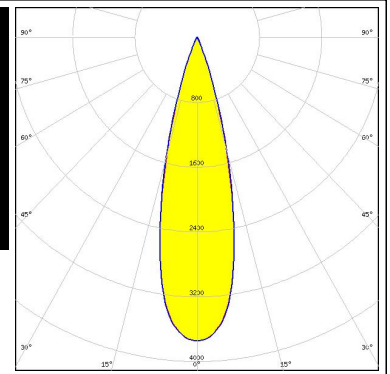

bridgelux

LED V9 HD Gen7
 Ordering code CP18776_YASMEEN-70-M-C2-WHT
 FWHM / FWTM 26.0° / 41.0°
 Efficiency 89 %
 Peak intensity 3.9 cd/lm
 LEDs/each optic 1
 Light colour White
 Required components:
 F15859_HEKLA-SOCKET-I

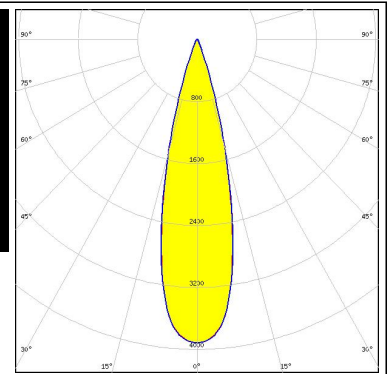
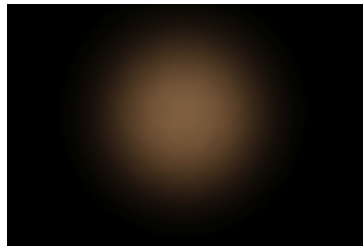

bridgelux

LED V9 HD Gen7
 Ordering code CP18762_YASMEEN-70-M-C2
 FWHM / FWTM 26.0° / 42.0°
 Efficiency 83 %
 Peak intensity 3.9 cd/lm
 LEDs/each optic 1
 Light colour White
 Required components:
 F15859_HEKLA-SOCKET-I

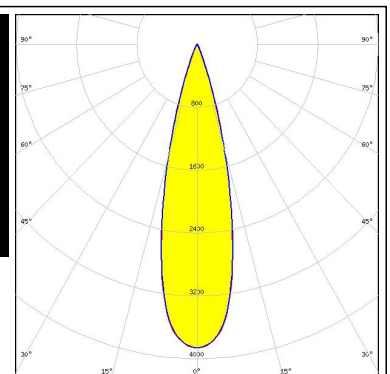
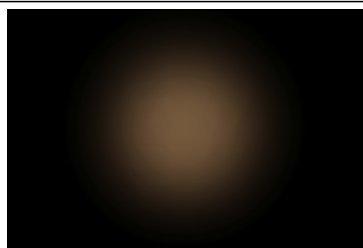

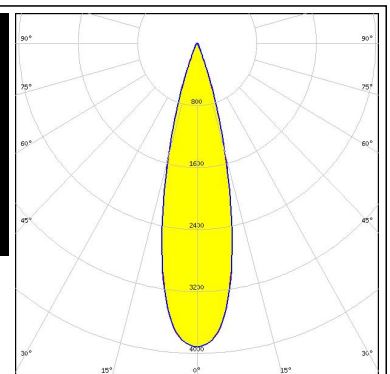

bridgelux

LED VERO10
 Ordering code CP18776_YASMEEN-70-M-C2-WHT
 FWHM / FWTM 26.0° / 42.0°
 Efficiency 90 %
 Peak intensity 3.9 cd/lm
 LEDs/each optic 1
 Light colour White
 Required components:
 F15616_HEKLA-SOCKET-F

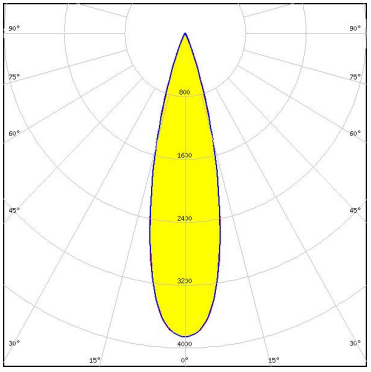

OPTICAL RESULTS (MEASURED):

			
LED	VERO10		
Ordering code	CP18762_YASMEEN-70-M-C2		
FWHM / FWTM	26.0° / 42.5°		
Efficiency	84 %		
Peak intensity	3.9 cd/m		
LEDs/each optic	1		
Light colour	White		
Required components:			
F15616_HEKLA-SOCKET-F			

			
LED	Vesta DTW 13mm (21W)		
Ordering code	CP18762_YASMEEN-70-M-C2		
FWHM / FWTM	25.0° / 46.0°		
Efficiency	81 %		
Peak intensity	3.7 cd/m		
LEDs/each optic	1		
Light colour	White		
Required components:			
Bender Wirth: 632b Hekla XL			

			
LED	Vesta DTW 15mm (33W)		
Ordering code	CP18776_YASMEEN-70-M-C2-WHT		
FWHM / FWTM	26.0° / 48.0°		
Efficiency	89 %		
Peak intensity	3.4 cd/m		
LEDs/each optic	1		
Light colour	White		
Required components:			
Bender Wirth: 632b Hekla XL			

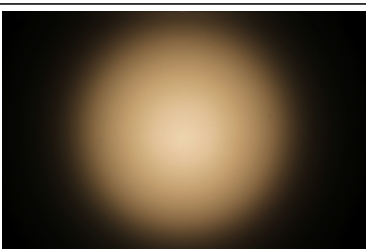
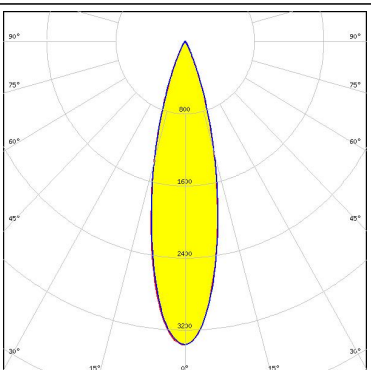
			
LED	Vesta DTW 15mm (33W)		
Ordering code	CP18762_YASMEEN-70-M-C2		
FWHM / FWTM	26.0° / 48.0°		
Efficiency	81 %		
Peak intensity	3.4 cd/m		
LEDs/each optic	1		
Light colour	White		
Required components:			
Bender Wirth: 632b Hekla XL			

OPTICAL RESULTS (MEASURED):



LED Vesta DTW 9mm (4W/6W/12W)
Ordering code CP18762_YASMEEN-70-M-C2
FWHM / FWTM 27.0° / 43.0°
Efficiency 83 %
Peak intensity 3.9 cd/lm
LEDs/each optic 1
Light colour White
Required components:
 Bender Wirth: 652b Hekla

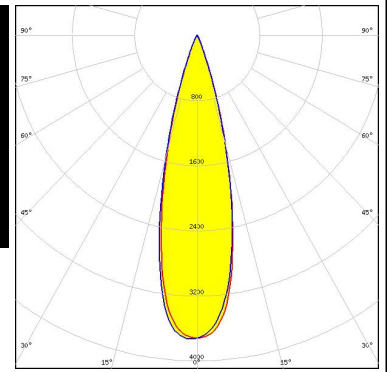
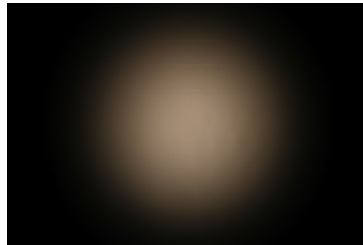

CITIZEN

LED CLL02x/CLU02x (LES10)
Ordering code CP18762_YASMEEN-70-M-C2
FWHM / FWTM 25.0° / 42.0°
Efficiency 83 %
Peak intensity 3.9 cd/lm
LEDs/each optic 1
Light colour White
Required components:
 F17435_HEKLA-G2-C

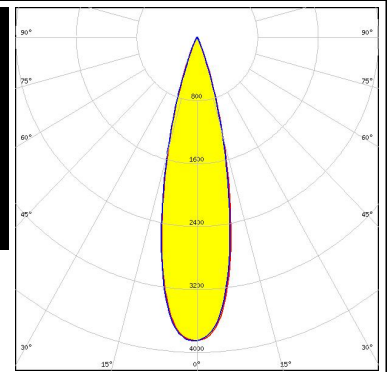
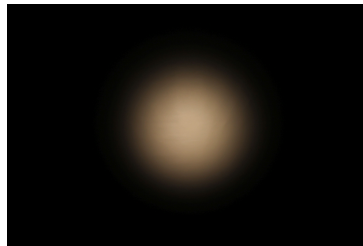

CITIZEN

LED CLL02x/CLU02x (LES10)
Ordering code CP18776_YASMEEN-70-M-C2-WHT
FWHM / FWTM 25.5° / 42.5°
Efficiency 89 %
Peak intensity 3.9 cd/lm
LEDs/each optic 1
Light colour White
Required components:
 F17435_HEKLA-G2-C

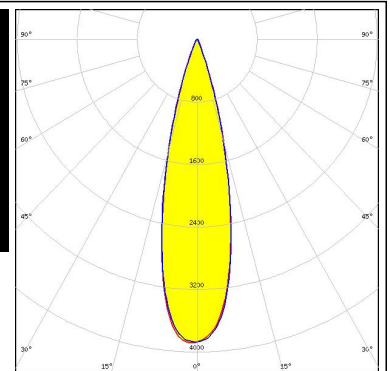
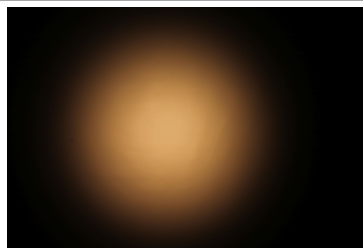

CITIZEN

LED CLL03x/CLU03x
Ordering code CP18762_YASMEEN-70-M-C2
FWHM / FWTM 25.0° / 45.0°
Efficiency 82 %
Peak intensity 3.7 cd/lm
LEDs/each optic 1
Light colour White
Required components:
 F17438_HEKLA-G2-I

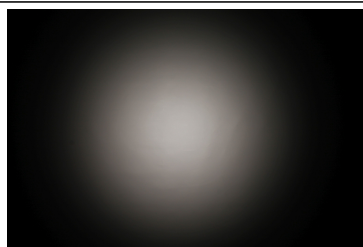

OPTICAL RESULTS (MEASURED):

CITIZEN

LED CLL03x/CLU03x
Ordering code CP18776_YASMEEN-70-M-C2-WHT
FWHM / FWTM 24.5° / 45.5°
Efficiency 89 %
Peak intensity 3.7 cd/lm
LEDs/each optic 1
Light colour White
Required components:
F17438_HEKLA-G2-I

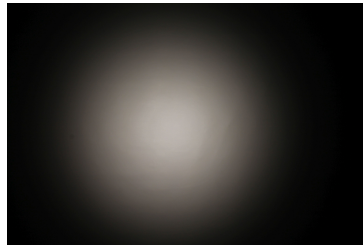

CREE LED

LED CMA1516
Ordering code CP18762_YASMEEN-70-M-C2
FWHM / FWTM 26.0° / 42.0°
Efficiency 83 %
Peak intensity 3.9 cd/lm
LEDs/each optic 1
Light colour White
Required components:
F17436_HEKLA-G2-D

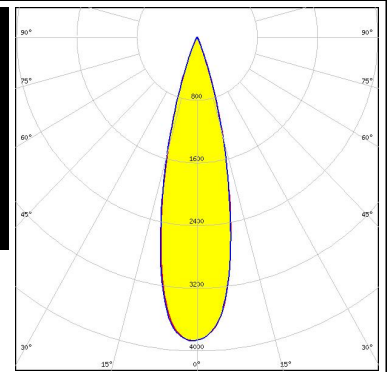
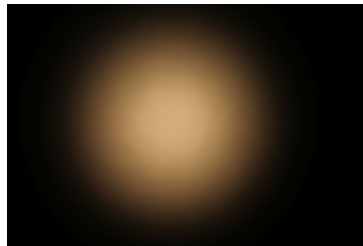

CREE LED

LED CMA1516
Ordering code CP18776_YASMEEN-70-M-C2-WHT
FWHM / FWTM 26.0° / 42.0°
Efficiency 90 %
Peak intensity 3.9 cd/lm
LEDs/each optic 1
Light colour White
Required components:
F17436_HEKLA-G2-D

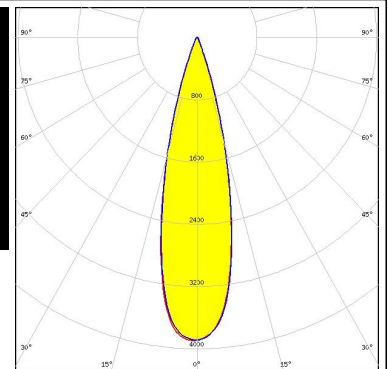
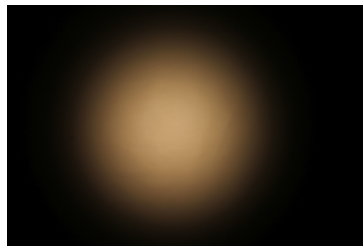

CREE LED

LED CMA1825
Ordering code CP18762_YASMEEN-70-M-C2
FWHM / FWTM 25.0° / 44.0°
Efficiency 83 %
Peak intensity 3.8 cd/lm
LEDs/each optic 1
Light colour White
Required components:
F15254_HEKLA-SOCKET-B

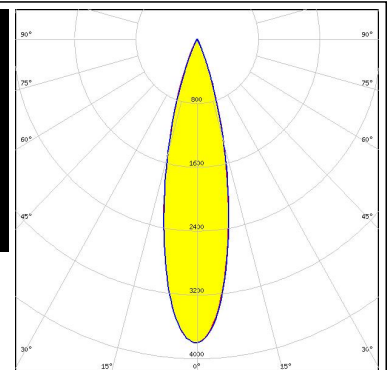
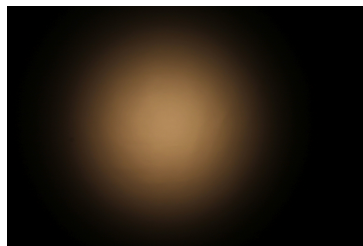

OPTICAL RESULTS (MEASURED):



LED CMA1825
Ordering code CP18776_YASMEEN-70-M-C2-WHT
FWHM / FWTM 25.0° / 44.0°
Efficiency 90 %
Peak intensity 3.8 cd/lm
LEDs/each optic 1
Light colour White
Required components:
F15254_HEKLA-SOCKET-B

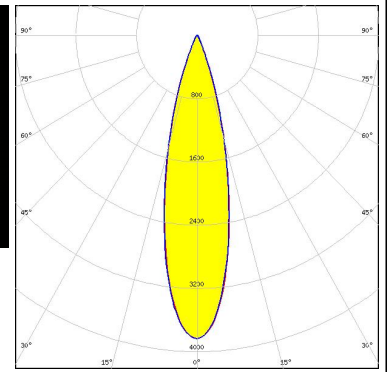
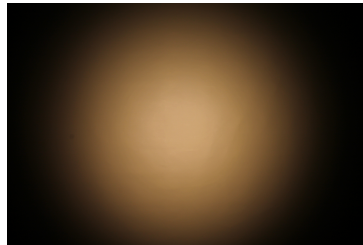

LED CMT14xx
Ordering code CP18762_YASMEEN-70-M-C2
FWHM / FWTM 26.0° / 42.0°
Efficiency 83 %
Peak intensity 3.8 cd/lm
LEDs/each optic 1
Light colour White
Required components:
F17435_HEKLA-G2-C

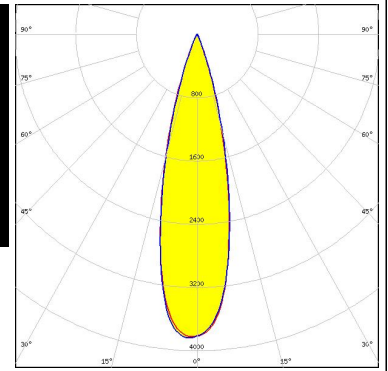

LED CMT14xx
Ordering code CP18776_YASMEEN-70-M-C2-WHT
FWHM / FWTM 26.0° / 43.0°
Efficiency 90 %
Peak intensity 3.8 cd/lm
LEDs/each optic 1
Light colour White
Required components:
F17435_HEKLA-G2-C

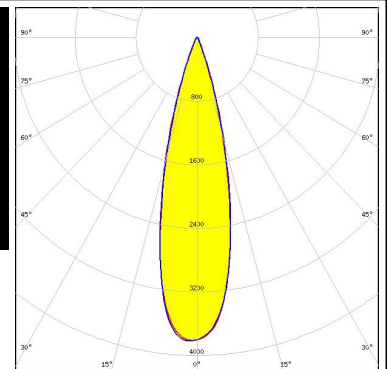
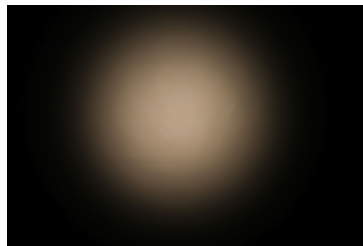

LED CMT19xx
Ordering code CP18762_YASMEEN-70-M-C2
FWHM / FWTM 24.0° / 45.0°
Efficiency 81 %
Peak intensity 3.6 cd/lm
LEDs/each optic 1
Light colour White
Required components:
F17438_HEKLA-G2-I

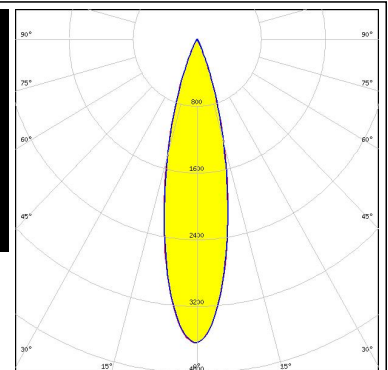
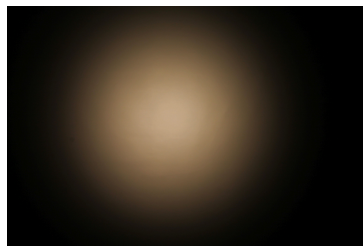

OPTICAL RESULTS (MEASURED):



LED CMT19xx
Ordering code CP18776_YASMEEN-70-M-C2-WHT
FWHM / FWTM 25.0° / 46.0°
Efficiency 89 %
Peak intensity 3.7 cd/lm
LEDs/each optic 1
Light colour White
Required components:
 F17438_HEKLA-G2-I

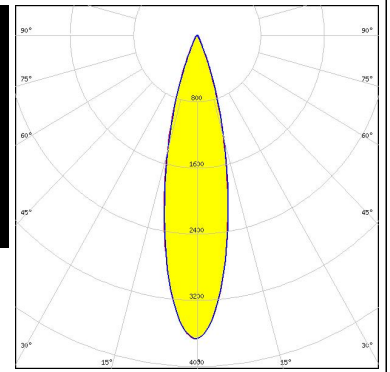
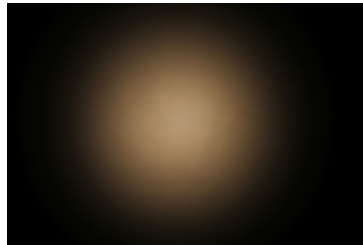

LED CMU15xx
Ordering code CP18762_YASMEEN-70-M-C2
FWHM / FWTM 26.0° / 47.0°
Efficiency 79 %
Peak intensity 3.3 cd/lm
LEDs/each optic 1
Light colour White
Required components:
 F17438_HEKLA-G2-I

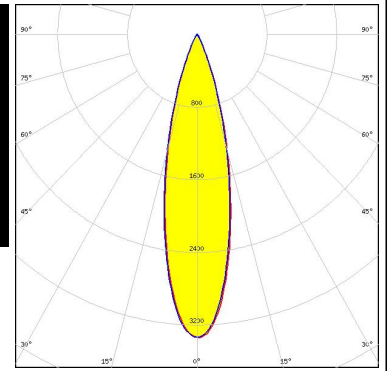

LED LUXEON CoB 1202/1203
Ordering code CP18762_YASMEEN-70-M-C2
FWHM / FWTM 26.0° / 42.0°
Efficiency 82 %
Peak intensity 3.9 cd/lm
LEDs/each optic 1
Light colour White
Required components:
 F17437_HEKLA-G2-H

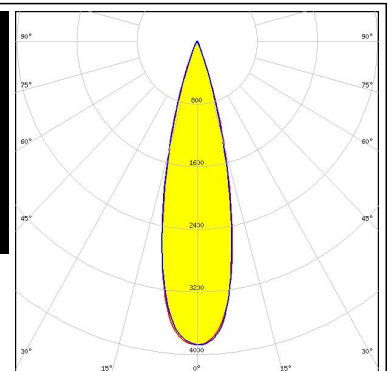
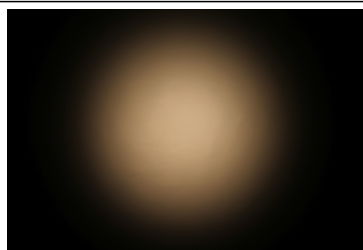

LED LUXEON CoB 1202/1203
Ordering code CP18776_YASMEEN-70-M-C2-WHT
FWHM / FWTM 26.0° / 42.0°
Efficiency 90 %
Peak intensity 3.9 cd/lm
LEDs/each optic 1
Light colour White
Required components:
 F17437_HEKLA-G2-H

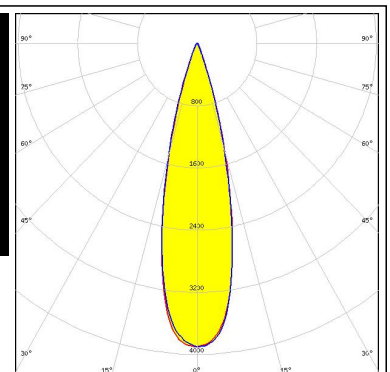
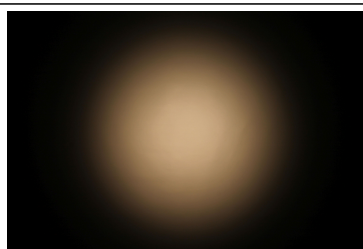

OPTICAL RESULTS (MEASURED):



LED COB L-Type (LES 11)
Ordering code CP18762_YASMEEN-70-M-C2
FWHM / FWTM 24.0° / 43.0°
Efficiency 82 %
Peak intensity 3.9 cd/lm
LEDs/each optic 1
Light colour White
Required components:
 F17437_HEKLA-G2-H

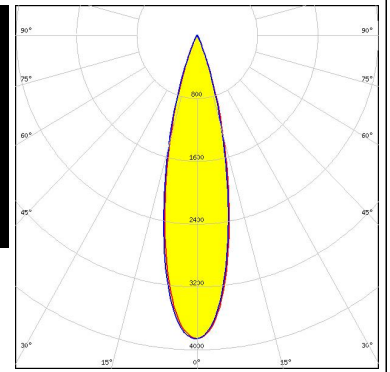
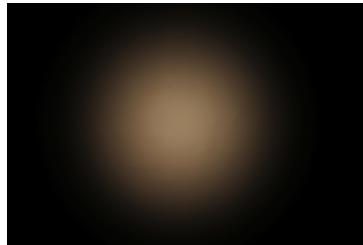

LED COB L-Type (LES 9)
Ordering code CP18762_YASMEEN-70-M-C2
FWHM / FWTM 26.0° / 42.0°
Efficiency 82 %
Peak intensity 3.8 cd/lm
LEDs/each optic 1
Light colour White
Required components:
 F17437_HEKLA-G2-H

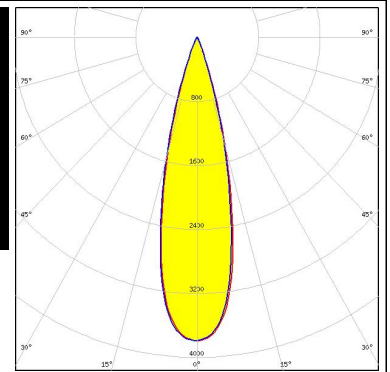
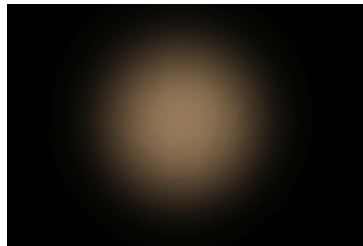

LED COB S-Type (LES 7)
Ordering code CP18762_YASMEEN-70-M-C2
FWHM / FWTM 24.0° / 45.0°
Efficiency 81 %
Peak intensity 3.8 cd/lm
LEDs/each optic 1
Light colour White
Required components:
 F17438_HEKLA-G2-I

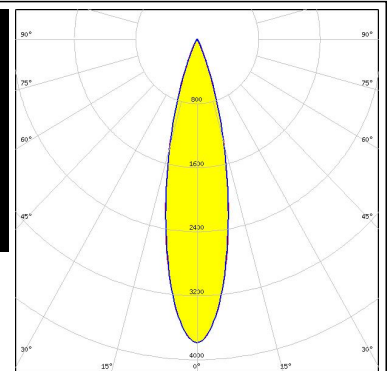
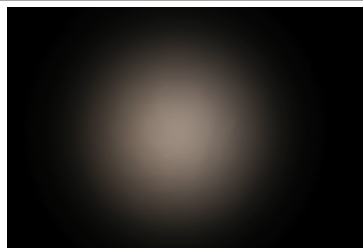

LED COB S-Type (LES 7)
Ordering code CP18776_YASMEEN-70-M-C2-WHT
FWHM / FWTM 24.0° / 44.0°
Efficiency 89 %
Peak intensity 3.8 cd/lm
LEDs/each optic 1
Light colour White
Required components:
 F17438_HEKLA-G2-I

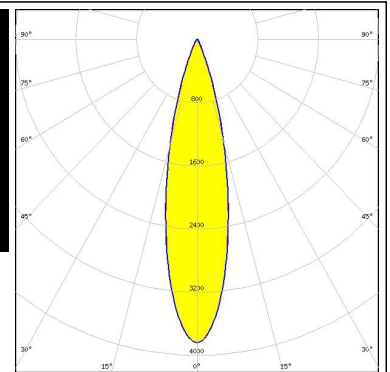
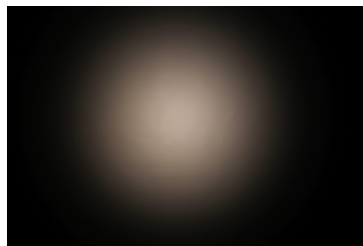

OPTICAL RESULTS (MEASURED):

PHILIPS

LED Fortimo SLM L09 CoB
Ordering code CP18762_YASMEEN-70-M-C2
FWHM / FWTM 25.0° / 42.0°
Efficiency 82 %
Peak intensity 3.9 cd/lm
LEDs/each optic 1
Light colour White
Required components:
F17437_HEKLA-G2-H

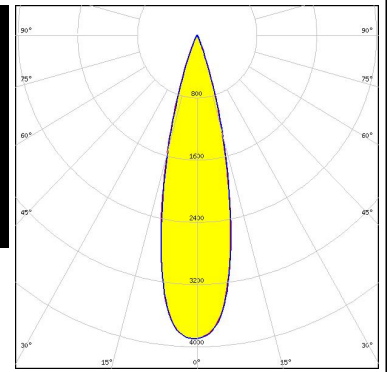

PHILIPS

LED Fortimo SLM L09 CoB
Ordering code CP18776_YASMEEN-70-M-C2-WHT
FWHM / FWTM 26.0° / 41.0°
Efficiency 90 %
Peak intensity 3.9 cd/lm
LEDs/each optic 1
Light colour White
Required components:
F17437_HEKLA-G2-H

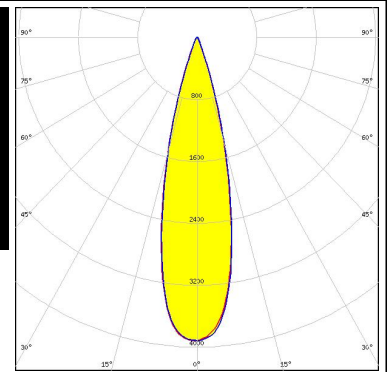
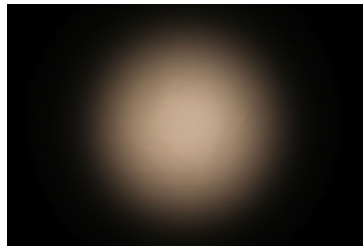

SAMSUNG

LED LC016D / LC019D / LC026D / LC033D
Ordering code CP18776_YASMEEN-70-M-C2-WHT
FWHM / FWTM 26.0° / 47.0°
Efficiency 89 %
Peak intensity 3.4 cd/lm
LEDs/each optic 1
Light colour White
Required components:
F17438_HEKLA-G2-I

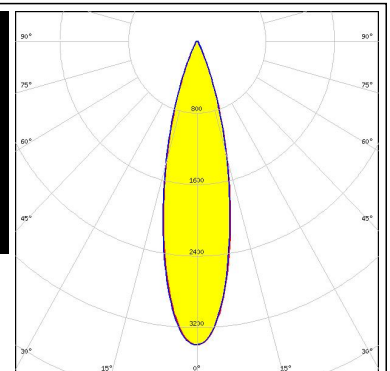
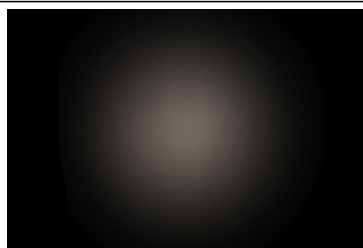

SAMSUNG

LED LC016D / LC019D / LC026D / LC033D
Ordering code CP18762_YASMEEN-70-M-C2
FWHM / FWTM 26.0° / 47.0°
Efficiency 81 %
Peak intensity 3.4 cd/lm
LEDs/each optic 1
Light colour White
Required components:
F17438_HEKLA-G2-I

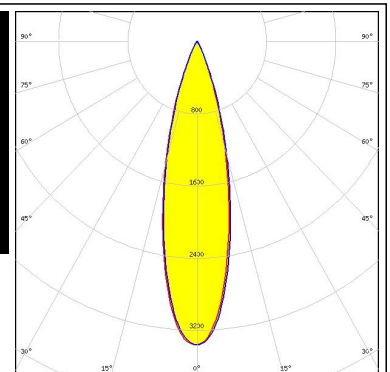

OPTICAL RESULTS (MEASURED):

SAMSUNG

LED LC030C/040C G2
 Ordering code CP18762_YASMEEN-70-M-C2
 FWHM / FWTM 25.0° / 45.0°
 Efficiency 82 %
 Peak intensity 3.9 cd/m
 LEDs/each optic 1
 Light colour White
 Required components:
 F17438_HEKLA-G2-I

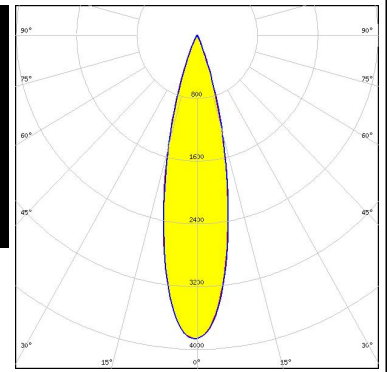
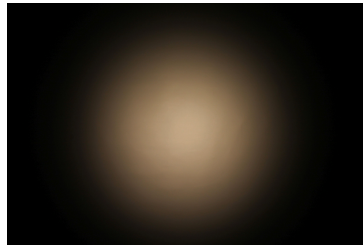

SAMSUNG

LED LC030C/040C G2
 Ordering code CP18776_YASMEEN-70-M-C2-WHT
 FWHM / FWTM 24.0° / 43.0°
 Efficiency 90 %
 Peak intensity 3.9 cd/m
 LEDs/each optic 1
 Light colour White
 Required components:
 F17438_HEKLA-G2-I

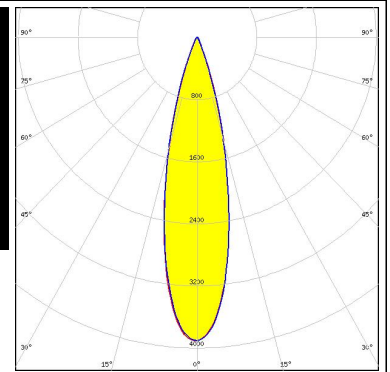
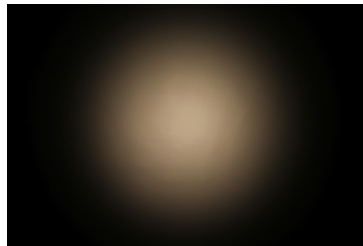

SEOUL SEMICONDUCTOR
 LED MJT COB LES 14.5
 Ordering code CP18776_YASMEEN-70-M-C2-WHT
 FWHM / FWTM 25.0° / 46.0°
 Efficiency 89 %
 Peak intensity 3.6 cd/m
 LEDs/each optic 1
 Light colour White
 Required components:
 F17438_HEKLA-G2-I

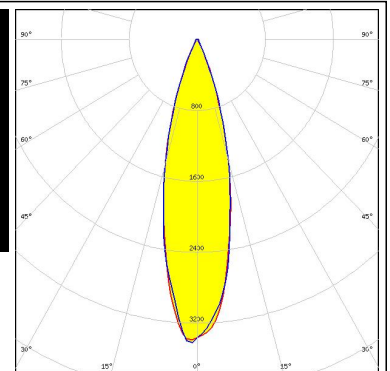
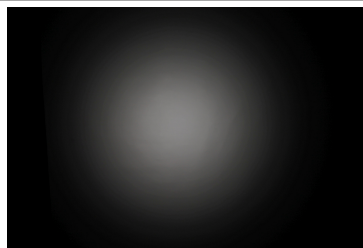

SEOUL SEMICONDUCTOR
 LED MJT COB LES 14.5
 Ordering code CP18762_YASMEEN-70-M-C2
 FWHM / FWTM 25.0° / 46.0°
 Efficiency 81 %
 Peak intensity 3.6 cd/m
 LEDs/each optic 1
 Light colour White
 Required components:
 F17438_HEKLA-G2-I

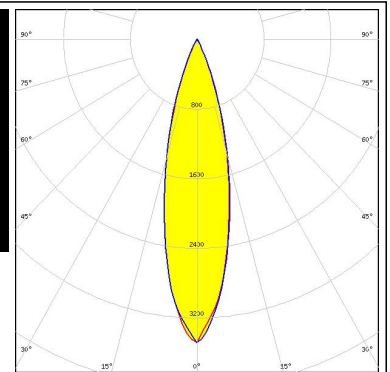

OPTICAL RESULTS (MEASURED):

TRIDONIC

LED SLE G7 LES09
Ordering code CP18762_YASMEEN-70-M-C2
FWHM / FWTM 26.0° / 42.0°
Efficiency 83 %
Peak intensity 3.9 cd/lm
LEDs/each optic 1
Light colour White
Required components:
F17435_HEKLA-G2-C

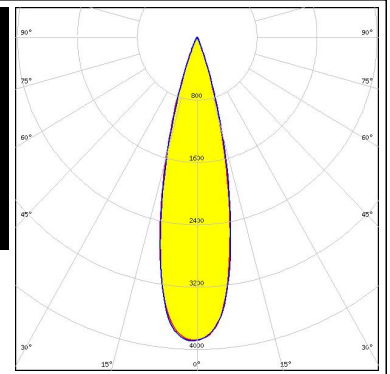

TRIDONIC

LED SLE G7 LES15
Ordering code CP18776_YASMEEN-70-M-C2-WHT
FWHM / FWTM 25.0° / 46.0°
Efficiency 90 %
Peak intensity 3.6 cd/lm
LEDs/each optic 1
Light colour White
Required components:
F17438_HEKLA-G2-I

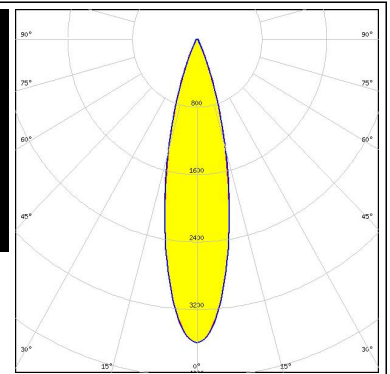
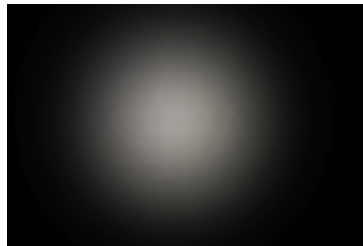

TRIDONIC

LED SLE G7 LES15
Ordering code CP18762_YASMEEN-70-M-C2
FWHM / FWTM 25.0° / 46.0°
Efficiency 81 %
Peak intensity 3.6 cd/lm
LEDs/each optic 1
Light colour White
Required components:
F17438_HEKLA-G2-I

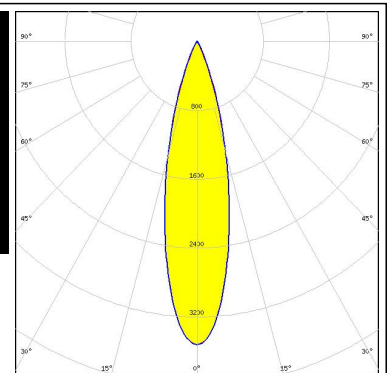
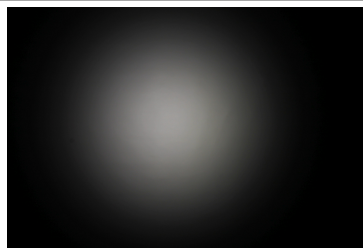

OPTICAL RESULTS (SIMULATED):



LED V13 Gen7
Ordering code CP18762_YASMEEN-70-M-C2
FWHM / FWTM 30.0° / 50.0°
Efficiency 86 %
Peak intensity 3.1 cd/lm
LEDs/each optic 1
Light colour White
Required components:

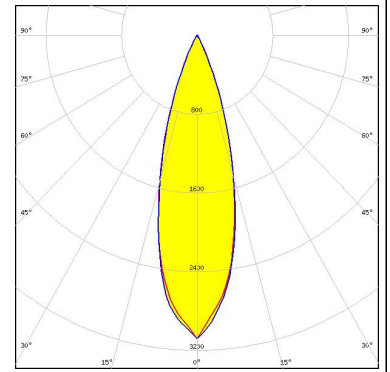

LED V6 HD Gen 7
Ordering code CP18762_YASMEEN-70-M-C2
FWHM / FWTM 30.0° / 42.0°
Efficiency 86 %
Peak intensity 3.7 cd/lm
LEDs/each optic 1
Light colour White
Required components:
F15255_HEKLA-SOCKET-C

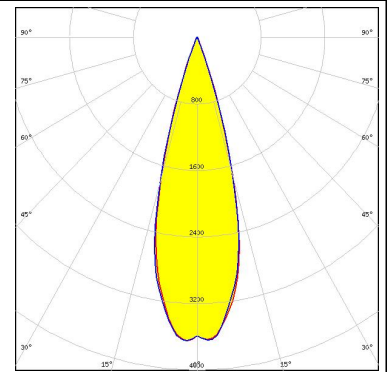

CITIZEN

LED CLL03x/CLU03x
Ordering code CP18769_YASMEEN-70-M-B2
FWHM / FWTM 26.0° / 46.0°
Efficiency 83 %
Peak intensity 3.5 cd/lm
LEDs/each optic 1
Light colour White
Required components:
BJB: 47.360.1010

CITIZEN

LED CLU712/713
Ordering code CP18762_YASMEEN-70-M-C2
FWHM / FWTM 28.0° / 42.0°
Efficiency 84 %
Peak intensity 3.8 cd/lm
LEDs/each optic 1
Light colour White
Required components:
F17438_HEKLA-G2-I

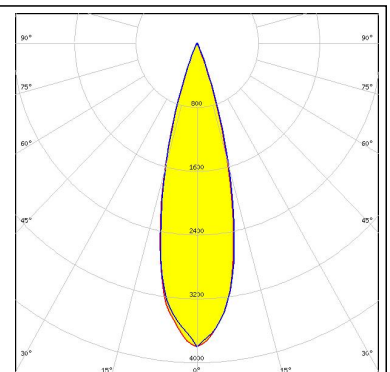

OPTICAL RESULTS (SIMULATED):



LED CHA0304
Ordering code CP18762_YASMEEN-70-M-C2
FWHM / FWTM 30.0° / 41.0°
Efficiency 85 %
Peak intensity 3.8 cd/lm
LEDs/each optic 1
Light colour White
Required components:
 F17435_HEKLA-G2-C

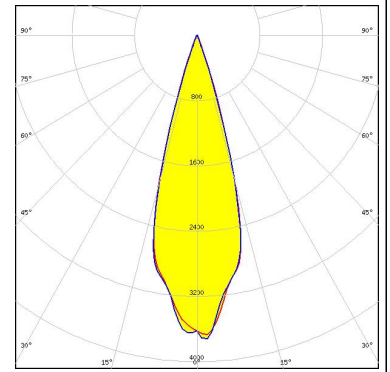

LED CHA0410
Ordering code CP18762_YASMEEN-70-M-C2
FWHM / FWTM 30.0° / 41.0°
Efficiency 85 %
Peak intensity 3.9 cd/lm
LEDs/each optic 1
Light colour White
Required components:
 F17435_HEKLA-G2-C

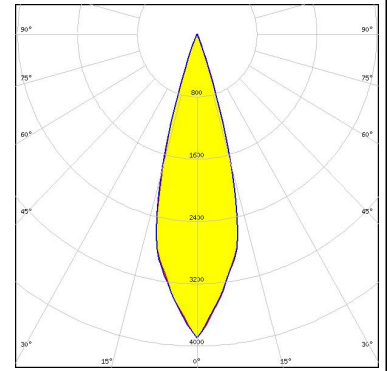

LED CHA0612
Ordering code CP18762_YASMEEN-70-M-C2
FWHM / FWTM 30.0° / 42.0°
Efficiency 85 %
Peak intensity 3.7 cd/lm
LEDs/each optic 1
Light colour White
Required components:
 F17435_HEKLA-G2-C

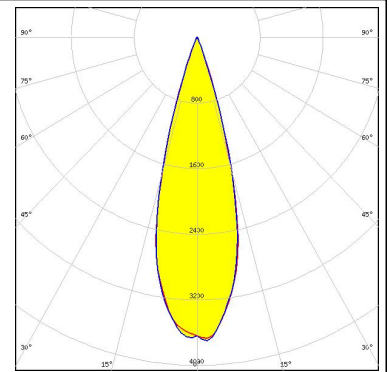

LED CMU10xx
Ordering code CP18762_YASMEEN-70-M-C2
FWHM / FWTM 27.0° / 44.0°
Efficiency 85 %
Peak intensity 3.9 cd/lm
LEDs/each optic 1
Light colour White
Required components:
 F17435_HEKLA-G2-C

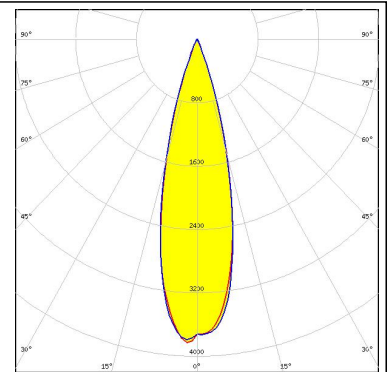

OPTICAL RESULTS (SIMULATED):



LED CXA/B 13xx
Ordering code CP18762_YASMEEN-70-M-C2
FWHM / FWTM 30.0° / 43.0°
Efficiency 85 %
Peak intensity 3.6 cd/lm
LEDs/each optic 1
Light colour White
Required components:
 F17439_HEKLA-G2-J

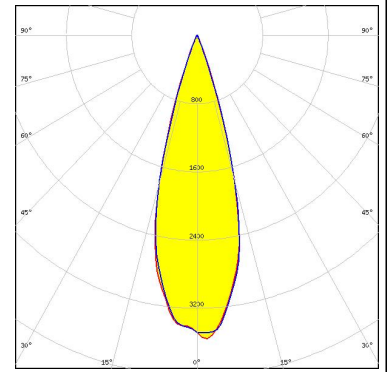

LED CXA/B 15xx
Ordering code CP18762_YASMEEN-70-M-C2
FWHM / FWTM 28.0° / 42.0°
Efficiency 84 %
Peak intensity 3.8 cd/lm
LEDs/each optic 1
Light colour White
Required components:
 F17436_HEKLA-G2-D

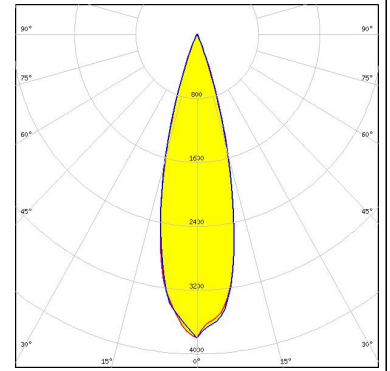

LED CXA/B 1830
Ordering code CP18762_YASMEEN-70-M-C2
FWHM / FWTM 26.0° / 46.0°
Efficiency 83 %
Peak intensity 3.6 cd/lm
LEDs/each optic 1
Light colour White
Required components:
 Bender Wirth: 637b Hekla

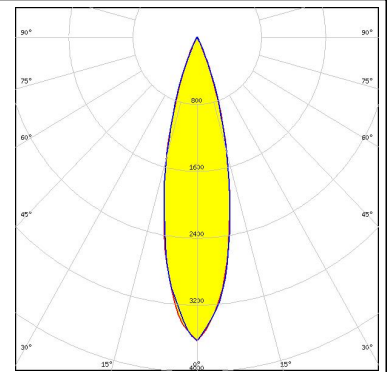

LED LC003D / LC006D / LC009D / LC013D
Ordering code CP18762_YASMEEN-70-M-C2
FWHM / FWTM 26.0° / 43.0°
Efficiency 84 %
Peak intensity 4 cd/lm
LEDs/each optic 1
Light colour White
Required components:
 F17435_HEKLA-G2-C

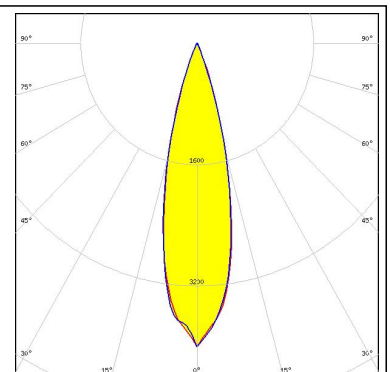

OPTICAL RESULTS (SIMULATED):

TRIDONIC

LED	SLE G7 LES13
Ordering code	CP18762_YASMEEN-70-M-C2
FWHM / FWTM	26.0° / 46.0°
Efficiency	83 %
Peak intensity	3.8 cd/lm
LEDs/each optic	1
Light colour	White
Required components:	
	F17438_HEKLA-G2-I

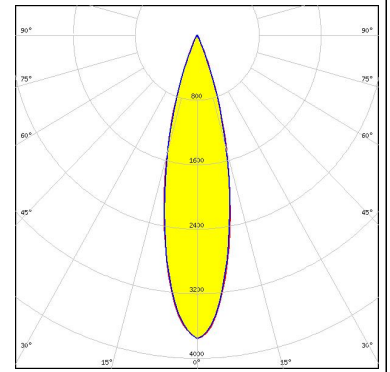

GENERAL INFORMATION:

NOTE: The typical beam angle will be changed by different color, chip size and chip position tolerance. The typical total beam angle is the full angle measured where the luminous intensity is half of the peak value.

Due to use of high power COB's with this product, special attention to proper thermal design is highly recommended. LEDiL has no liability for direct, indirect or consecutive damages arising from the LEDiL products being used outside of the recommended temperature range.

MATERIALS:

As part of our continuous research and improvement processes, and to ensure the best possible quality and availability of our products, LEDiL reserves the right to change material grades without notice.

PRODUCT DATA USER AGREEMENT AND DISCLAIMER:

The measured data in the provided downloadable LEDiL Product Datasheets and Mechanical 2D-Drawings is rounded and provided as reference for planning. LEDiL Oy's optical specifications have been verified by conducting performance testing of the products in accordance with the company's quality system. The reported data are averaged results of multiple measurements with typical variation. LEDiL Oy reserves the right to without prior notification make changes and improvements to its products.

LEDiL Oy assumes neither warranty, nor guarantee nor any other liability of any kind for the contents and correctness of the provided data. The provided data has been generated with highest diligence but the provided data may in reality not represent the complete possible variation range of all intrinsic parameters. Therefore, in certain cases a deviation from the provided data could occur.

LEDiL Oy reserves the right to undertake technical changes of its products without further notification which could lead to changes in the provided data. LEDiL Oy assumes no liability of any kind for the possible deviation from any provided data or any other damage resulting from the usage of the provided data.

The user agrees to this disclaimer and user agreement with the download or usage of the provided files.

LEDiL Oy

Joensuunkatu 13
FI-24240 SALO
Finland

LEDiL Inc.

228 West Page Street
Suite D
Sycamore IL 60178
USA

Ledil Optics Technology (Shenzhen) Co., Ltd.

405 , Block B
Casic Motor Building
Shenzhen 518057
P.R.CHINA

Local sales and technical support

[www.ledil.com/
where_to_buy](http://www.ledil.com/where_to_buy)

Shipping locations

Salo, Finland
Hong Kong, China

Distribution Partners

[www.ledil.com/
where_to_buy](http://www.ledil.com/where_to_buy)

Mouser Electronics

Authorized Distributor

Click to View Pricing, Inventory, Delivery & Lifecycle Information:

Ledil:

[CP18762_YASMEEN-70-M-C2](#) [CP18769_YASMEEN-70-M-B2](#) [CP18776_YASMEEN-70-M-C2-WHT](#)
[CP18783_YASMEEN-70-M-B2-WHT](#)