

REV.	ECN NO.	DATE	SIGN	DESCRIPTION
D	LEN1690093~104	2016/09/03	Joyy	Modify the packaging and quantity
E	LEN1790140~51	2017-08-29	Lingpeng	Change The Note
F	NI80019	2017-08-29	Lingpeng	Add 5 Pole

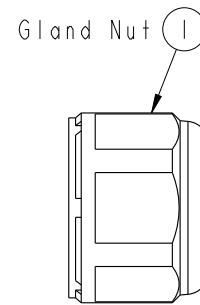

ALTW
CONFIDENTIAL
 2019-03-14
 R&D DEPT.

6 Connector

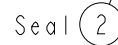
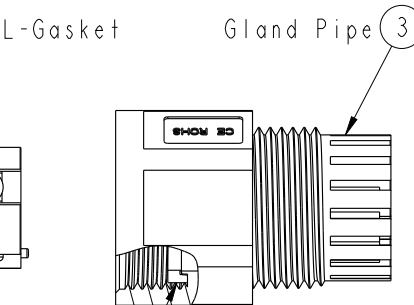
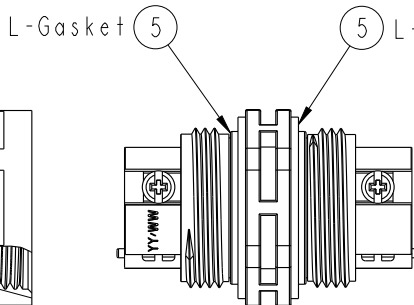
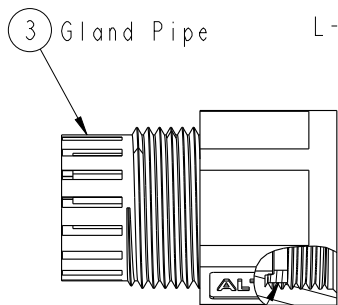
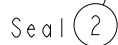
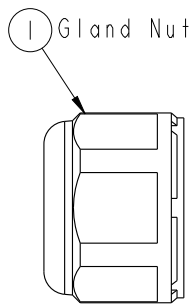
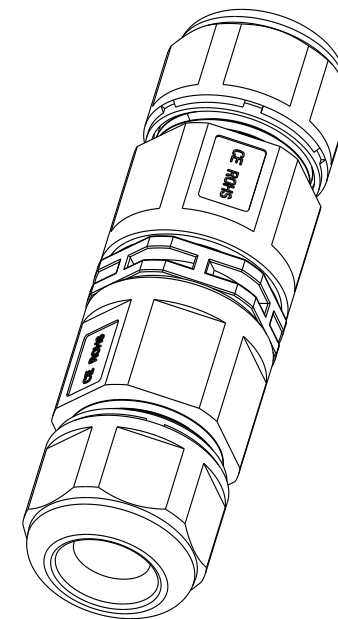
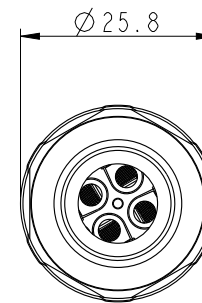
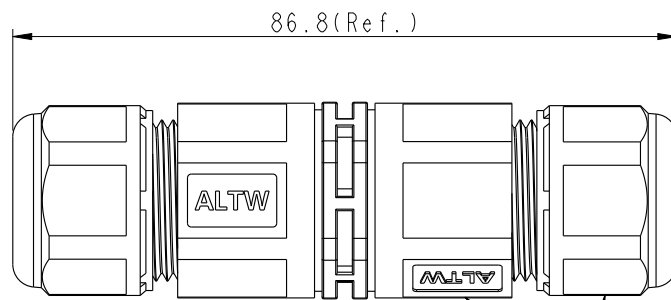
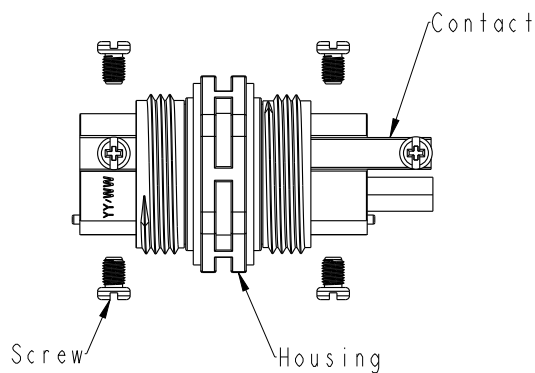

UNIT:mm
 TOLERANCE ±0.5mm

TITLE
 PG11 Cable Joiner
 Screw-in Type

SCALE 1:1
 SIZE A4
 SHEET 1 OF 2







REV. F
 WC-REV. A.13
 Inspection item

Amphenol LTW
 安費諾亮泰企業股份有限公司

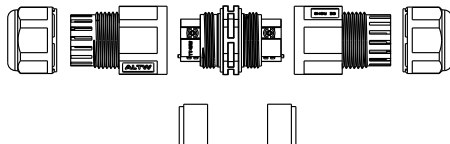
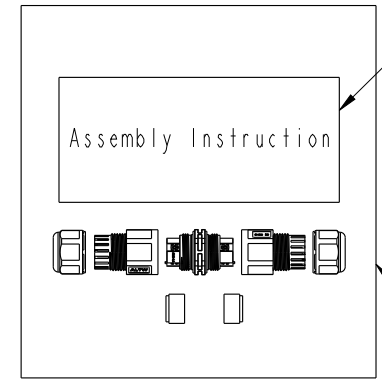
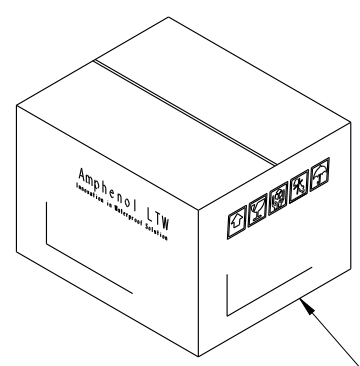
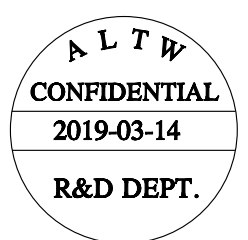
ITEM NO	DRAWN BY	DATE
	Lingpeng	2019-03-14
DWG NO	CHECKED BY	DATE
SC-L-PG11-XX-XX	Ma Fei	2019-03-14
CUSTOMER	APPROVED BY	DATE
ALTW	Jerry	2019-03-14

THIS DOCUMENT IS SUBJECT TO CHANGE WITHOUT NOTICE. IT IS CONFIDENTIAL AND A PROPERTY OF Amphenol LTW. DISCLOSURE TO THIRD PARTY HAS TO BE AUTHORIZED BY Amphenol LTW.

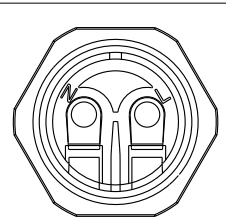
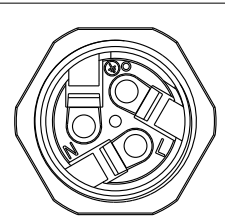
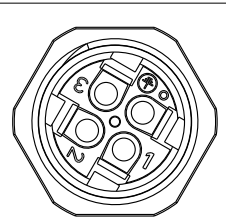
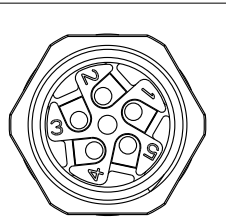
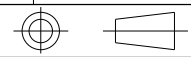
THIS DOCUMENT IS SUBJECT TO CHANGE WITHOUT NOTICE. IT IS CONFIDENTIAL AND A PROPERTY OF Amphenol LTW. DISCLOSURE TO THIRD PARTY HAS TO BE AUTHORIZED BY Amphenol LTW.

D	 <p>QTY: 1PCS</p> <p>→</p>		 <p>8 Instruction</p> <p>Assembly Instruction</p> <p>QTY: 120PCS</p> <p>→</p> <p>7 PE Bag</p>		 <p>9 Carton</p>			
E	<p>SC-L-PGII-XX-XX</p> <p>L: Cable Joiner</p> <p>Type: PGII</p>		<p>Both A Unassembled product And An Instruction Are In A PE Bag. (將一套未組裝的產品和說明書，放置於一個PE袋，並封口)</p> <p>Seal's Color: BL-Blue(藍色) For Cable Range: $\varnothing 4.5\sim\varnothing 6.5\text{mm}$ YW-Yellow(黃色) For Cable Range: $\varnothing 6.5\sim\varnothing 8.5\text{mm}$ GN-Green(綠色) For Cable Range: $\varnothing 8.5\sim\varnothing 10.5\text{mm}$ RD-Red(紅色) For Cable Range: $\varnothing 10.5\sim\varnothing 12.5\text{mm}$ AA-All Seals For Cable Range: $\varnothing 4.5\sim\varnothing 12.5\text{mm}$</p> <p>No. of Conductor: 02-2Poles 03-3Poles 04-4Poles 05-5Poles</p>		<p>Note:  </p> <ul style="list-style-type: none"> *  Important Dimension To Check. * Waterproof Rate: IP68 (50M,24H) * Housing: PA66+GF, Black. * Gland Nut: PA6+GF, Black. * Gland Pipe: PA66, Black. * Contact: Brass, Nickel Plated * Gasket & L-Gasket : Silicone, Yellow. * Seal: Silicone, Blue & Yellow & Green & Red. * Rated Voltage: 2~4 Pole 450V AC * Rated Current: 2 Pole Max. 30A , 3 & 4 Pole Max. 20A, 5 Pole Max. 16A * Operating Temperature: $-40^{\circ}\sim+105^{\circ}$. * Gland Pipe Recommended Tightening Torque: 8~10 Kgf.cm(0.78~0.98 N.m) * Gland Nut Recommended Tightening Torque: 8~10 Kgf.cm(0.78~0.98 N.m) * Seal For Cable OD: $\varnothing 4.5\sim\varnothing 6.5\text{mm}$, Blue. $\varnothing 6.5\sim\varnothing 8.5\text{mm}$, Yellow. $\varnothing 8.5\sim\varnothing 10.5\text{mm}$, Green . $\varnothing 10.5\sim\varnothing 12.5\text{mm}$, Red. * Screws for Wire connection recommended tightening torque: 2.00~4.50kgf.cm / 0.196~0.44 N.m * Applicable Wire gauge (Stranded wire cross section) 2~4Pole: 0.75mm^2 (18AWG) ~ 2.5mm^2 (14AWG) 5Pole: 0.5mm^2 (20AWG) ~ 1.5mm^2 (16AWG) 			
D	<p>SC-L-PGII-XX-XX</p>							
C								
B	<p>Pole Assignments Front View</p>  <p>2 Pole</p>		 <p>3 Pole</p>		 <p>4 Pole</p>		 <p>5 Pole</p>	
A	<p>UNIT:mm</p>  <p>TOLERANCE $\pm 0.5\text{mm}$</p>	<p>TITLE PGII Cable Joiner Screw-in Type</p> <p>SCALE 1:1 SIZE A4 SHEET 2 OF 2</p> <p>REV. F WC-REV. A.13  Inspection item</p>		<h1>Amphenol LTW</h1> <p>安費諾亮泰企業股份有限公司</p>		<p>ITEM NO</p> <p>DWG NO SC-L-PGII-XX-XX</p> <p>CUSTOMER ALTW</p>	<p>DRAWN BY Lingpeng</p> <p>CHECKED BY Ma Fei</p> <p>APPROVED BY Jerry</p>	<p>DATE 2019-03-14</p> <p>DATE 2019-03-14</p> <p>DATE 2019-03-14</p>
							8 W10814-03-001A2	

Mouser Electronics

Authorized Distributor

Click to View Pricing, Inventory, Delivery & Lifecycle Information:

[Amphenol:](#)

[SC-L-PG11-03-GN](#) [SC-L-PG11-02-YW](#) [SC-L-PG11-03-BL](#) [SC-L-PG11-04-YW](#) [SC-L-PG11-04-RD](#) [SC-L-PG11-02-RD](#) [SC-L-PG11-03-YW](#) [SC-L-PG11-04-GN](#) [SC-L-PG11-02-GN](#) [SC-L-PG11-03-RD](#) [SC-L-PG11-04-BL](#) [SC-L-PG11-02-BL](#) [SC-L-PG11-02-00](#) [SC-L-PG11-04-00](#) [SC-L-PG11-03-00](#)