

CGRA4001-G Thru. CGRA4007-G

Reverse Voltage: 50 to 1000 Volts
 Forward Current: 1.0 Amp
 RoHS Device

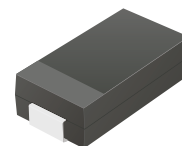

Features

- Glass Passivation Junction.
- High current capability.
- High surge current capability.
- Low reverse current.

Mechanical data

- Case: DO-214AC / SMA, molded plastic.
- Epoxy: UL flammability classification rate 94V-0.
- Terminals: Lead free plating (Tin finish).
 Solderable per MIL-STD-750, Method 2026.
- Polarity: Indicated by cathode band.
- Weight: 0.062 grams(approx.).

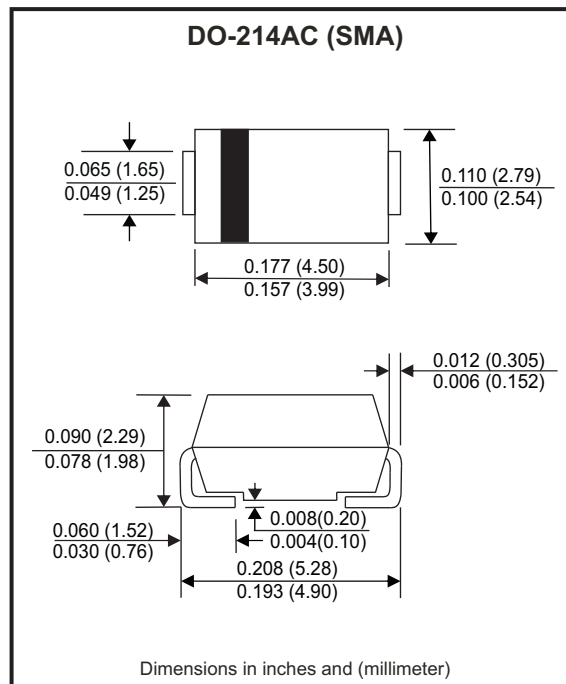

Circuit diagram



Maximum Ratings (at TA=25°C unless otherwise noted)

Parameter	Symbol	CGRA 4001-G	CGRA 4002-G	CGRA 4003-G	CGRA 4004-G	CGRA 4005-G	CGRA 4006-G	CGRA 4007-G	Units	
Max. repetitive peak reverse voltage	V_{RRM}	50	100	200	400	600	800	1000	V	
Max. DC blocking voltage	V_{DC}	50	100	200	400	600	800	1000	V	
Max. RMS voltage	V_{RMS}	35	70	140	280	420	560	700	V	
Peak forward surge current, 8.3ms single half sine-wave superimposed on rated load (JEDEC method)	I_{FSM}	30							A	
Max. average forward rectified current	I_F	1.0							A	
Max. instantaneous forward voltage $I_F=1.0A @ 25^\circ C$	V_F	1.1							V	
Max. DC reverse current at rated	I_R	$T_A=25^\circ C$	5							μA
DC blocking voltage		$T_A=100^\circ C$	50							
Typical junction capacitance (Note 1)	C_J	10							pF	
Typical thermal resistance	$R_{\theta JC}$	70							$^\circ C/W$	
Operating temperature range	T_J	-55 to +150							$^\circ C$	
Storage temperature range	T_{STG}	-55 to +150							$^\circ C$	

Notes: 1. Measured at 1.0MHZ and applied reverse voltage of 4.0V DC.

Company reserves the right to improve product design , functions and reliability without notice.

REV: E

Rating and Characteristic Curves (CGRA4001-G thru. CGRA4007-G)

Fig.1 - Typical Forward Current Derating Curve

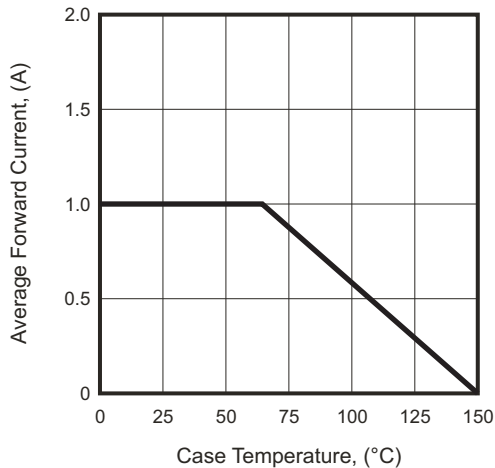

Fig.2 - Typical Forward Characteristics

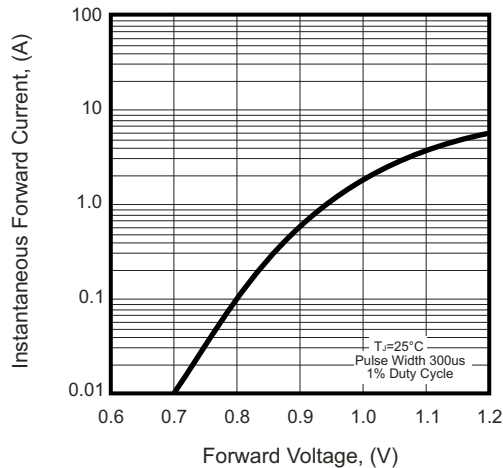

Fig.3 - Maximum Non-repetitive Forward Surge Current

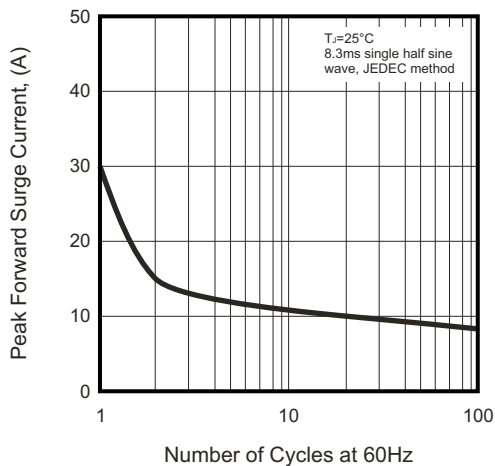

Fig.4 - Typical Reverse Characteristics

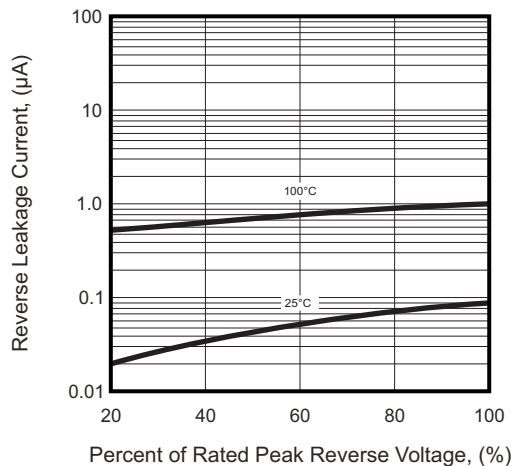
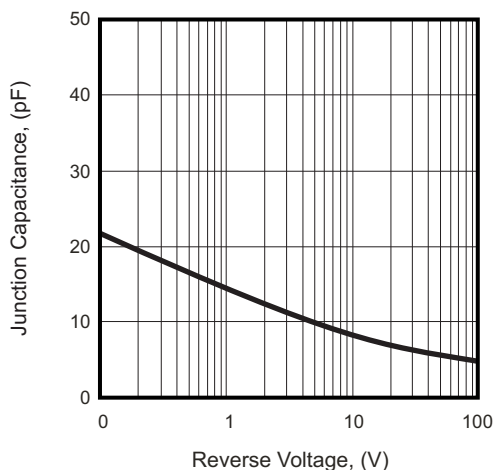

Fig.5 - Typical Junction Capacitance



Company reserves the right to improve product design, functions and reliability without notice.

REV: E

Reel Taping Specification

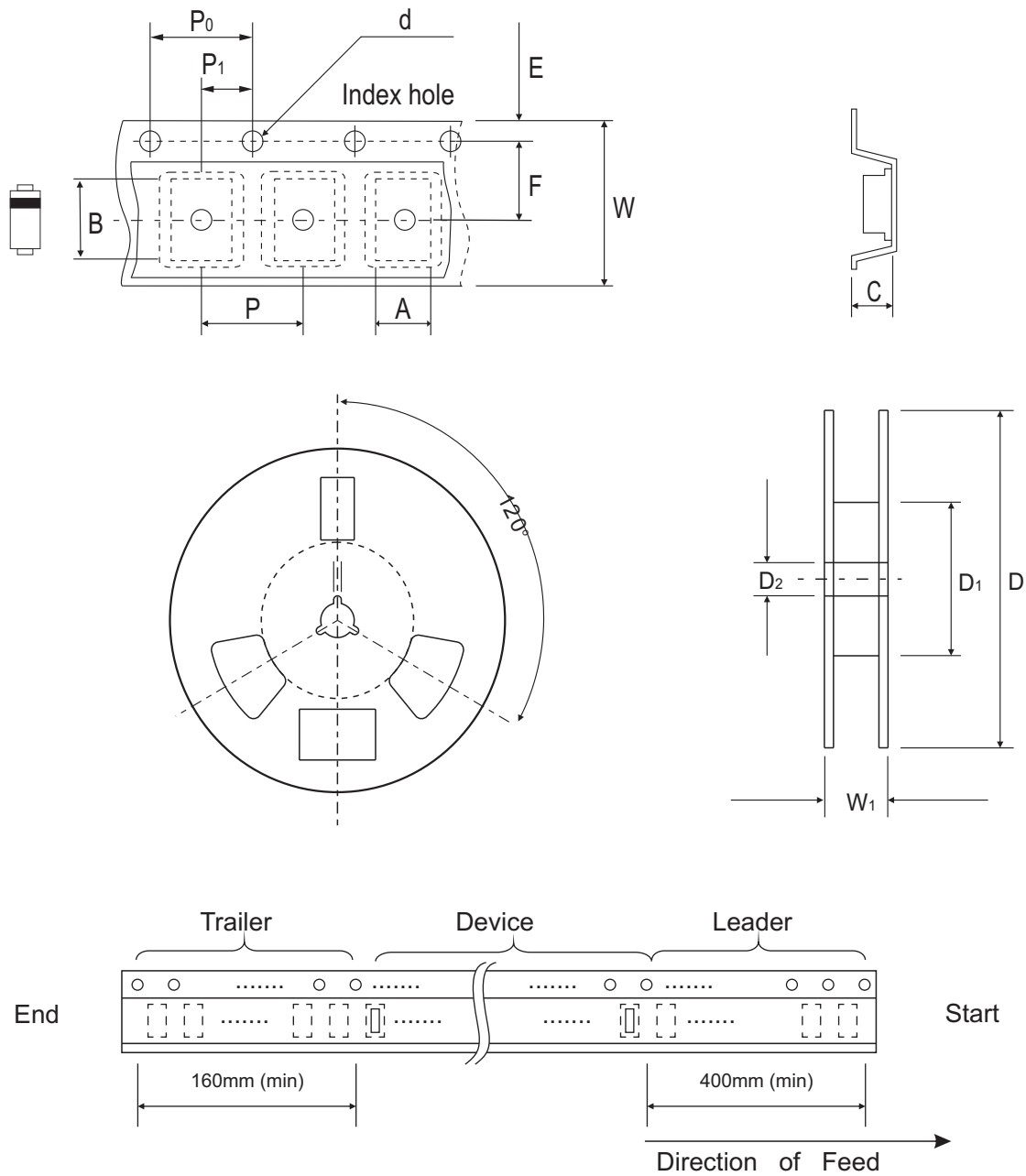

DO-214AC (SMA)	SYMBOL	A	B	C	d	D	D ₁	D ₂
	(mm)	2.90 MAX.	5.90 MAX.	2.66 MAX.	1.50 ± 0.10	330 ± 2.00	50 MIN.	13.50 ± 1.00
	(inch)	0.114 MAX.	0.232 MAX.	0.105 MAX.	0.059 ± 0.004	13.00 ± 0.079	1.969 MIN.	0.531 ± 0.039

DO-214AC (SMA)	SYMBOL	E	F	P	P ₀	P ₁	W	W ₁
	(mm)	1.75 ± 0.10	5.50 ± 0.05	4.00 ± 0.10	4.00 ± 0.10	2.00 ± 0.05	12.00 ± 0.30	18.40 MAX.
	(inch)	0.069 ± 0.004	0.217 ± 0.002	0.157 ± 0.004	0.157 ± 0.004	0.079 ± 0.002	0.472 ± 0.012	0.724 MAX.

Company reserves the right to improve product design, functions and reliability without notice.

REV: E

Marking Code

Part Number	Marking code
CGRA4001-G	4001
CGRA4002-G	4002
CGRA4003-G	4003
CGRA4004-G	4004
CGRA4005-G	4005
CGRA4006-G	4006
CGRA4007-G	4007

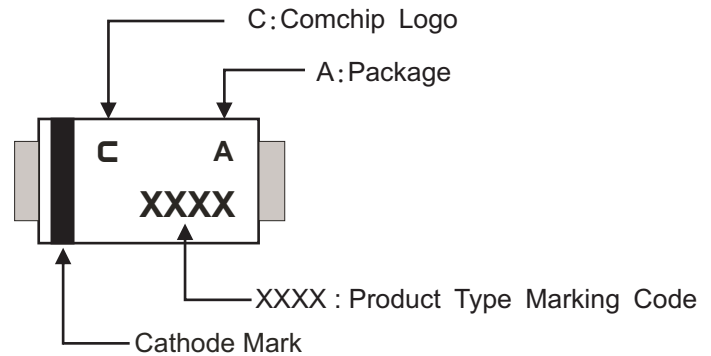

Suggested PAD Layout

SIZE	DO-214AC (SMA)	
	(mm)	(inch)
A	1.70	0.067
B	2.50	0.098
C	1.50	0.059
D	4.00	0.157
E	6.50	0.256

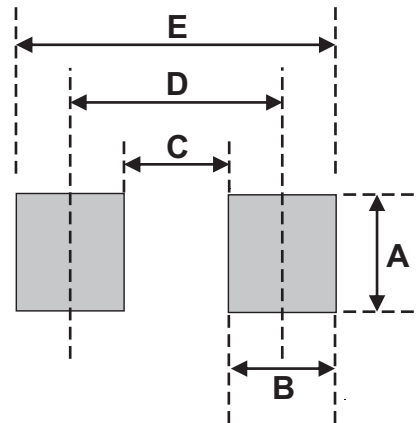

Note:

1. The pad layout is for reference purposes only.

Standard Packaging

Case Type	REEL PACK	
	REEL (pcs)	Reel Size (inch)
DO-214AC (SMA)	5,000	13

Mouser Electronics

Authorized Distributor

Click to View Pricing, Inventory, Delivery & Lifecycle Information:

[Comchip Technology:](#)

[CGRA4001-G](#)