

USB3 female to female keystone coupler, wired 1:1



USB3 A female to A female keystone coupler (KCUAA311wh)

This USB3 keystone coupler can be used as an interconnection point between two A-A cables. With its standardised dimensions it can be used for easy snap-in mounting in a keystone patch panel, face plate or surface-mount box.

Features

- USB 3.0 style keystone coupler type (A female connectors on the front and back)
- Wired pin 1 : 1 and clearly marked with wiring
- Connection from and to USB1.1, USB2.0 and USB3.0
- Standard format keystone fits a wide range of panels, adaptors and faceplates
- Available as part of our innovative new panel mount and D UNIVERSAL ranges

Specifications:

- Dimensions: 34.3x16.2x19.5mm (LxWxH)
- Weight: approx. 10g
- Housing: ABS UL94V-0
- Colour: white
- Connection: USB3.0 F/F
- Packaging: Supplied in individual polythene bags, then in bags of 20.

ROHS Compliant

Code: KCUAA311wh

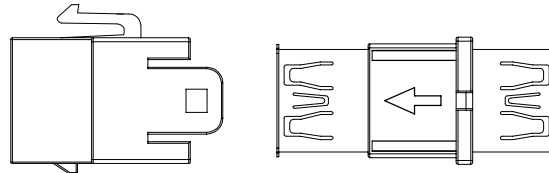
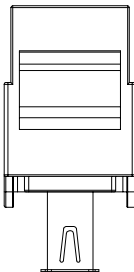
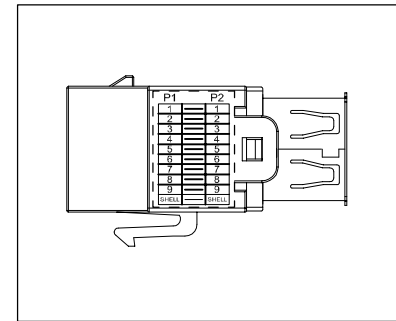
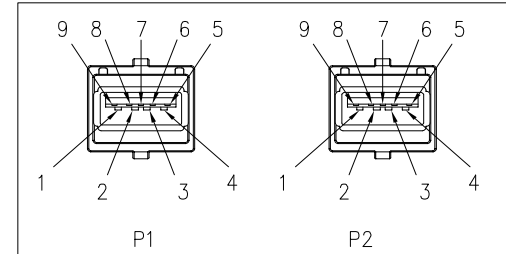
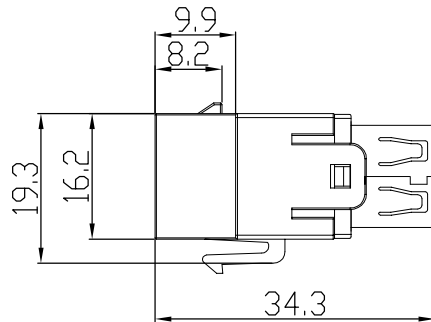
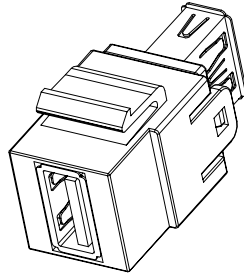
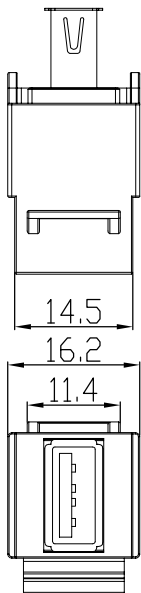

P1		P2	
1	---	1	---
2	---	2	---
3	---	3	---
4	---	4	---
5	---	5	---
6	---	6	---
7	---	7	---
8	---	8	---
9	---	9	---
SHELL	---	SHELL	---