

THIS DOCUMENT IS THE PROPERTY OF KEYSTONE ELECTRONICS CORP. AND SHALL NOT BE REPRODUCED, DISTRIBUTED OR USED AS A BASIS FOR MANUFACTURE WITHOUT PRIOR WRITTEN PERMISSION FROM KEYSTONE ELECTRONICS CORP.

MOUNTING DETAIL

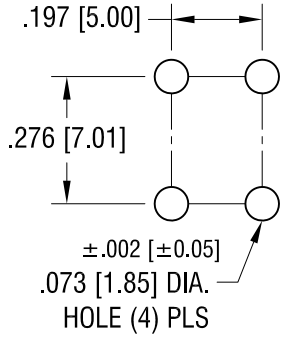

6-32 x 1/4 L.
CAPTIVATED SCREW

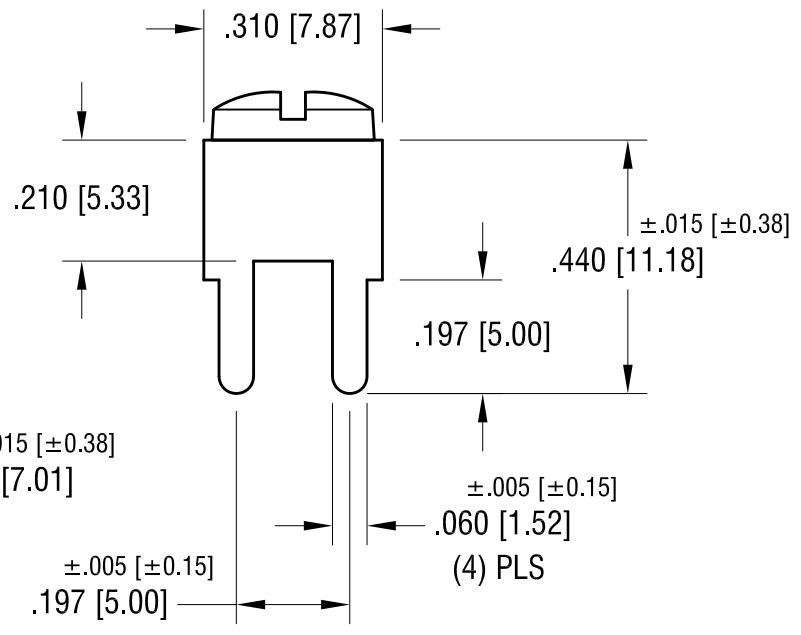
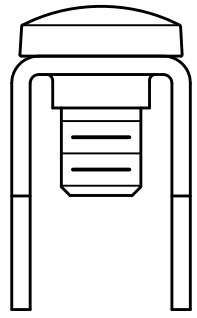
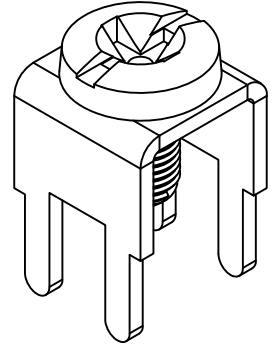
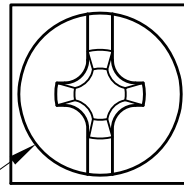

PC SCREW TERMINAL WITH COLORED SCREW HEAD

PART NO.	HEAD COLOR	PART NO.	HEAD COLOR
7701-2	RED	7701-5	BLUE
7701-3	BLACK	7701-6	GREEN
7701-4	WHITE	7701-7	YELLOW

NOTES:

- 1. TERMINAL:
MAT'L - .032 [0.81] TH'K BRASS, MATTE TIN PLATE
- SCREW:
MAT'L - BRASS, NICKEL PLATE

DATE	DESCRIPTION	REV.
7.13.09	CHANGE AS PER ECN 09-099	B
1.7.08	CHANGE AS PER ECN 08-034	A

KEYSTONE ELECTRONICS CORP.

www.keyelco.com • ASTORIA, N.Y. 11105-2017 • Tel (718) 956-8900

PART NAME
PC SCREW TERM. W/ COLORED SCREW HEAD

MATERIAL
AS NOTED

FINISH AS NOTED	DRN BY	BOONE	DATE	10.1.03
	APP'D	LN	SCALE	3X

TOLERANCES	INCH	[MM]	CODE	DWG NO.
DECIMAL	± .010	[± 0.25]	C	7701-2 - 7701-7
ANGULAR	± 1°			

UNLESS OTHERWISE SPECIFIED

Mouser Electronics

Authorized Distributor

Click to View Pricing, Inventory, Delivery & Lifecycle Information:

[Keystone Electronics:](#)

[7701-2](#)