



PARA LIGHT ELECTRONICS CO., LTD.

11F., No. 8, Jiankang Rd., Zhonghe Dist., New Taipei City 235, Taiwan,

Tel: 886-2-2225-3733

Fax: 886-2-2225-4800

E-mail: para@para.com.tw www.paralighttaiwan.com

DATA SHEET

PART NO. : LRR5UW5C193G-YX

REV: A / 1

CUSTOMER'S APPROVAL: _____

DCC: _____

DRAWING NO. : DS-G-35-17-0038

DATE: 2021-03-31

Page: 1

5.0 mm DIA CYLINDRICAL LED LAMP

LRR5UW5C193G-YX

REV:A / 1

PACKAGE DIMENSIONS

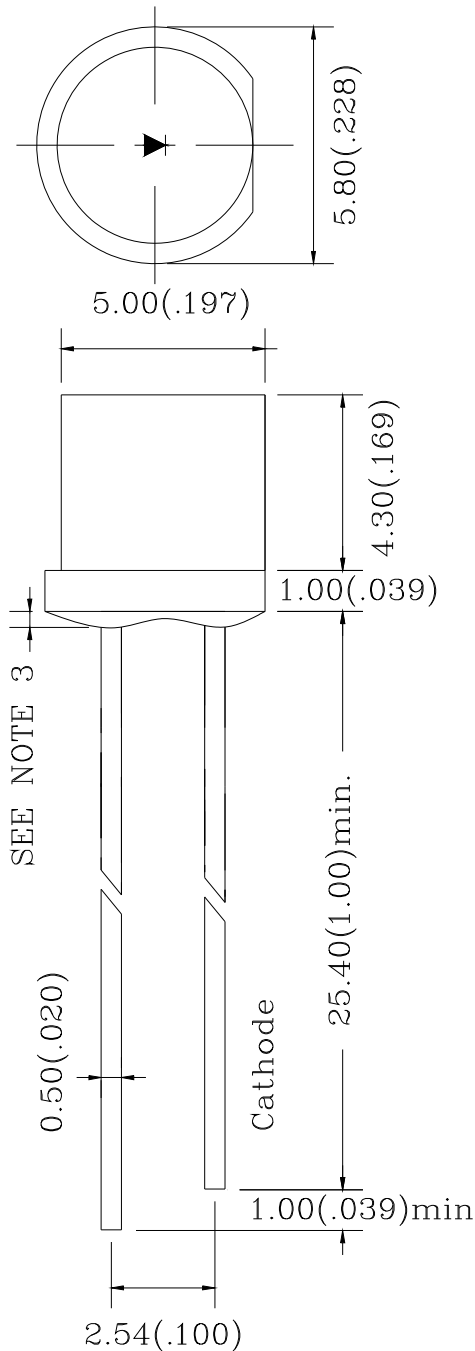

Note:

1. All Dimensions are in millimeters.
2. Tolerance is $\pm 0.25\text{mm}$ (0.010 ") Unless otherwise specified.
3. Protruded resin under flange is 1.5mm (0.059 ") max.
4. Lead spacing is measured where the leads emerge from the package.
5. Specification are subject to change without notice
6. highlight <-500V the led can withstand the max static level when assembling or operation.

5.0 mm DIA CYLINDRICAL LED LAMP

LRR5UW5C193G-YX

REV:A / 1

FEATURES

- * SUITABLE HIGH PULSE CURRENT OPERATION
- * EXTRA HIGH RADIANT POWER AND RADIANT INTENSITY
- * HIGH RELIABILITY
- * LOW FORWARD VOLTAGE

CHIP MATERIALS

- * Dice Material : GaInN/GaN
- * Light Color : ULTRA WHITE
- * Lens Color : WATER CLEAR

ABSOLUTE MAXIMUM RATING:(Ta=25°C)

SYMBOL	DESCRIPTION	ULTRA WHITE	UNIT
PAD	Power Dissipation Per Chip	68	mW
VR	Reverse Voltage Per Chip	5	V
IAF	Average Forward Current Per Chip	20	mA
IFP -	Peak Forward Current Per Chip (Duty=0.1,1KHZ)	80	mA
ESD	Electrostatic Discharge Threshold(HBM)Note A	<1000	V
Topr	Operating Temperature Range	-40°C to 85°C	
Tstg	Storage Temperature Range	-40°C to 85°C	

ELECTRO-OPTICAL CHARACTERISTICS:(Ta=25°C)

SYMBOL	DESCRIPTION	TEST CONDITION	MIN.	TYP.	MAX.	UNIT
VF	Forward Voltage	IF = 20mA		3.0	3.4	V
IR	Reverse Current	VR = 5V			10	μA
2θ1/2	Half Intensity Angle	IF = 20mA		100		deg
IV	Luminous Intensity	IF = 20mA	-	1000	-	mcd
X	Chromaticity Coordinates	IF = 20mA		0.28		
Y		IF = 20mA		0.27		

5.0 mm DIA CYLINDRICAL LED LAMP

LRR5UW5C193G-YX

REV:A / 1

■ Forward Voltage vs. Forward Current

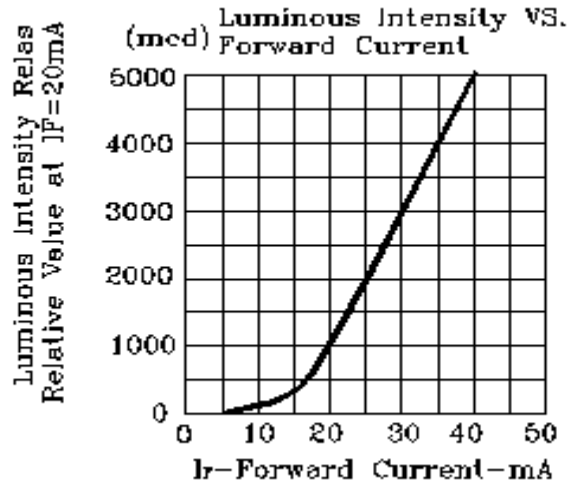
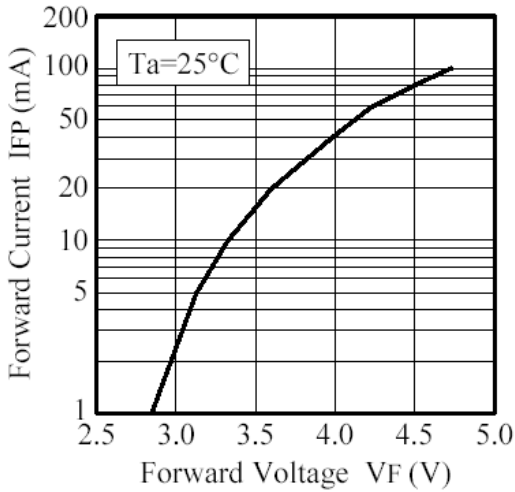

■ Duty Ratio vs. Allowable Forward Current

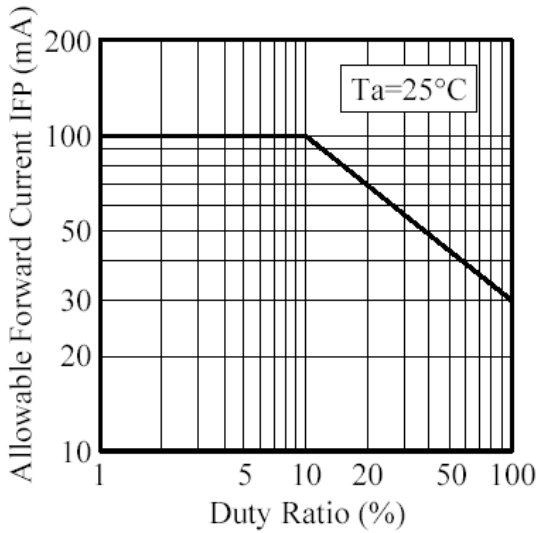

■ Ambient Temperature vs. Forward Voltage

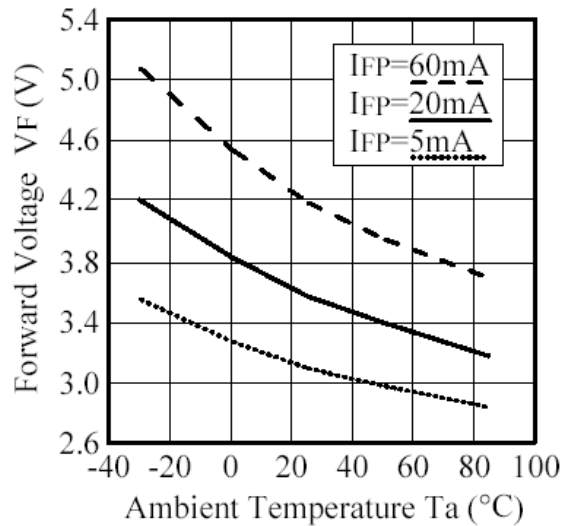

5.0 mm DIA CYLINDRICAL LED LAMP

LRR5UW5C193G-YX

REV:A / 1

■ Ambient Temperature vs. Relative Luminosity

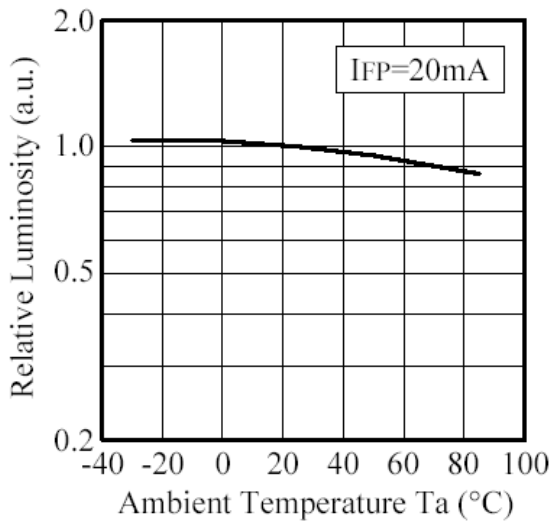

■ Ambient Temperature vs. Allowable Forward Current

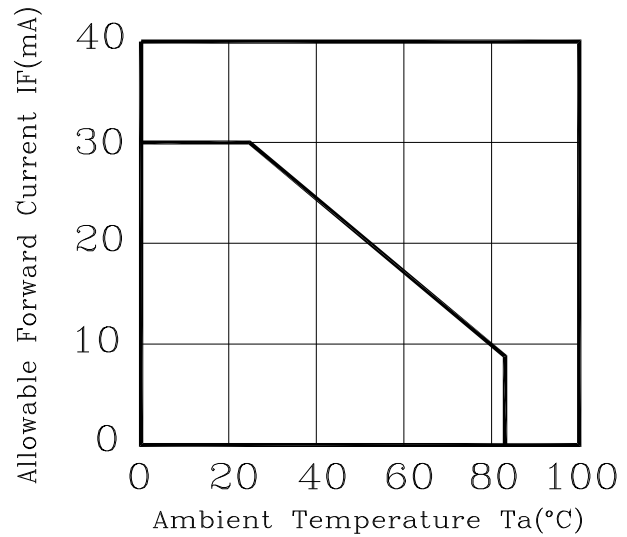

■ Forward Current vs. Chromaticity Coordinate

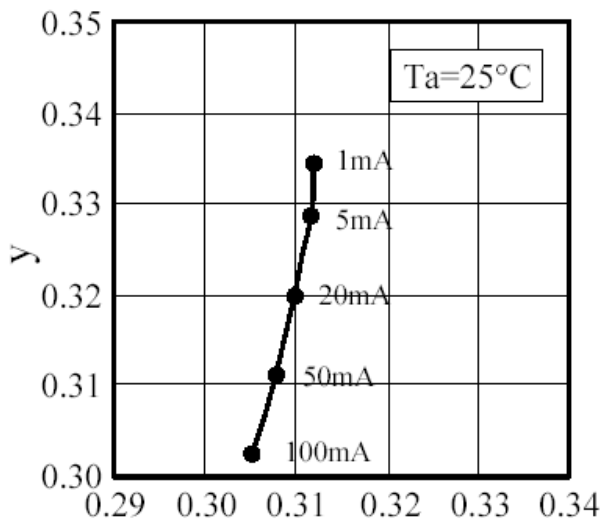

■ Spectrum

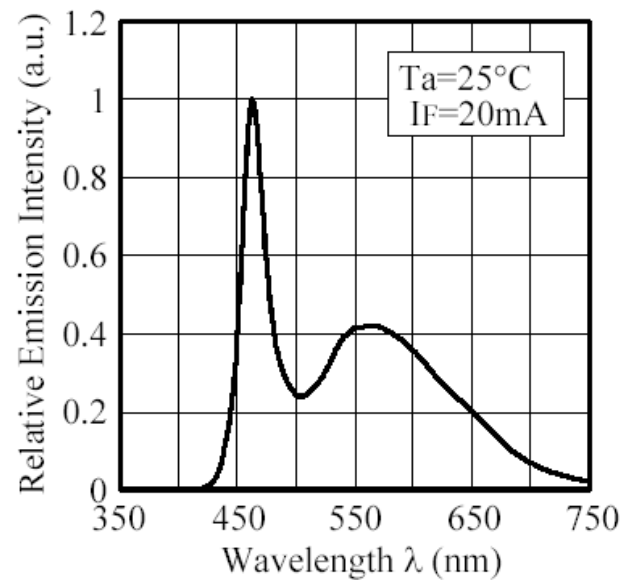

5.0 mm DIA CYLINDRICAL LED LAMP

LRR5UW5C193G-YX

REV:A / 1

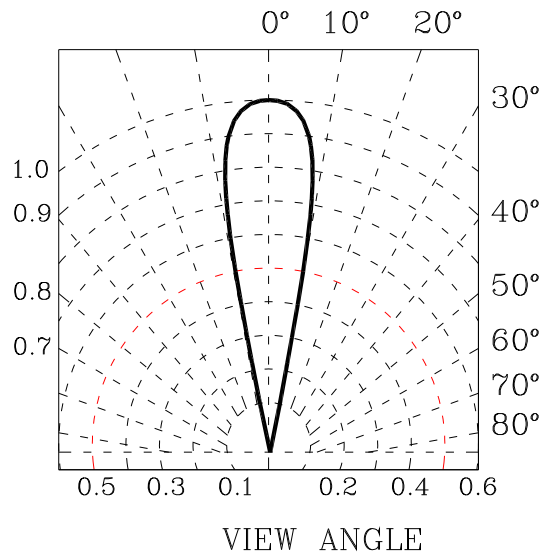

Label Explanation

PARA NO. :	
LOT NO. :	INSPECTED
BIN :	
Q' TY :	PCS
N. W :	g

PARA NO. : Refer to p14

LOT NO. : **E L L 4 7 0009**

A B C D E F

- A---E: For series number
- B---L: Local F: Foreign
- C---L: LAMP
- D---Year
- E---Month
- F---SPEC.

5.0 mm DIA CYLINDRICAL LED LAMP

LRR5UW5C193G-YX

REV:A / 1

•SOLDERING

METHOD	SOLDERING CONDITIONS	REMARK
DIP SOLDERING	Bath temperature: 260°C Immersion time: with 5 sec, 1 time	<ul style="list-style-type: none"> • Solder no closer than 3mm from the base of the package • Using soldering flux, "RESIN FLUX" is recommended.
SOLDERING IRON	Soldering iron: 30W or smaller Temperature at tip of iron: 300°C or lower Soldering time: within 3 sec.	<ul style="list-style-type: none"> • During soldering, take care not to press the tip of iron against the lead. <p>(To prevent heat from being transferred directly to the lead, hold the lead with a pair of tweezers while soldering</p>

1) When soldering the lead of LED in a condition that the package is fixed with a panel (See FIG.1), be careful not to stress the leads with iron tip.

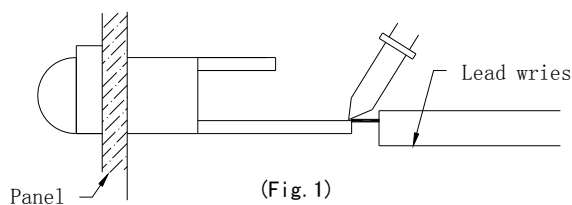

2) When soldering wire to the lead, work with a Fig (See Fig.2) to avoid stressing the package.

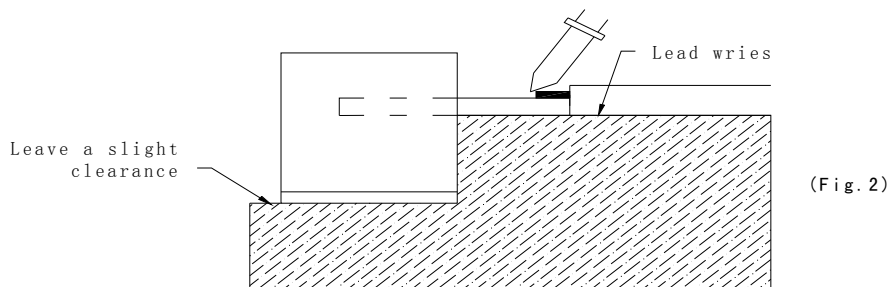

5.0 mm DIA CYLINDRICAL LED LAMP

LRR5UW5C193G-YX

REV:A / 1

- 3) Similarly, when a jig is used to solder the LED to PC board, take care as much as possible to avoid steering the leads (See Fig.3).

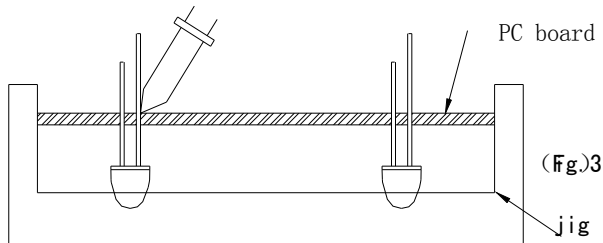

- 4) Repositioning after soldering should be avoided as much as possible. If inevitable, be sure to preserve the soldering conditions with irons stated above: select a best-suited method that assures the least stress to the LED.
- 5) Lead cutting after soldering should be performed only after the LED temperature has returned to normal temperature.

•LED MOUNTING METHOD

- 1) When mounting the LED by using a case, as shown Fig.4, ensure that the mounting holds on the PC board match the pitch of the leads correctly-tolerance of dimensions of the respective components including the LED should be taken into account especially when designing the case, PC board, etc. to prevent pitch misalignment between the leads and board holes, the diameter of the board holes should be slightly larger than the size of the lead. Alternatively, the shape of the holes should be made oval. (See Fig.4)

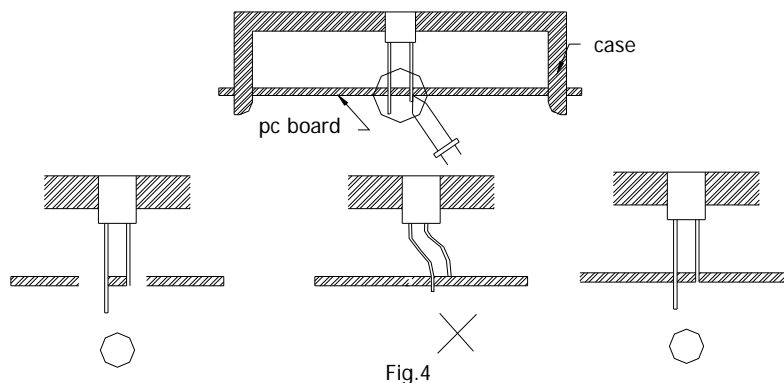

5.0 mm DIA CYLINDRICAL LED LAMP

LRR5UW5C193G-YX

REV:A / 1

2) Use LEDs with stand-off (Fig.5) or the tube or spacer made of resin (Fig.6) to position the LEDs.

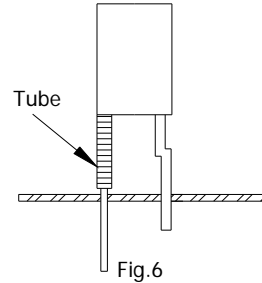
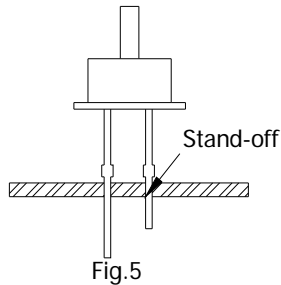

●FORMED LEAD

1) The lead should be bent at a point located at least 2mm away from the package. Bending should be performed with base fixed means of a jig or pliers (Fig.7)

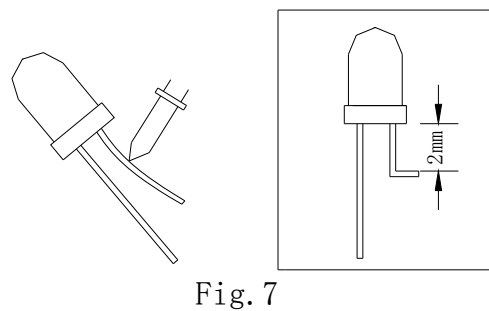

2) Forming lead should be carried out prior to soldering and never during or after soldering.

3) Form the lead of ensure alignment between the leads and the hole on board, so that stress against the LED is prevented. (Fig.8)

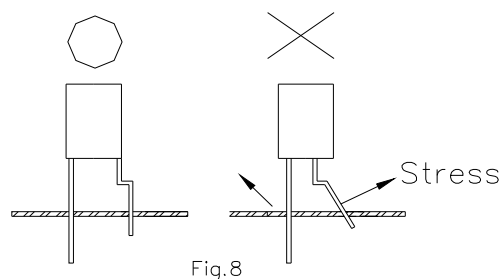

5.0 mm DIA CYLINDRICAL LED LAMP

LRR5UW5C193G-YX

REV:A / 1

●LEAD STRENGTH

1) Bend strength

Do not bend the lead more than twice. (Fig.9)

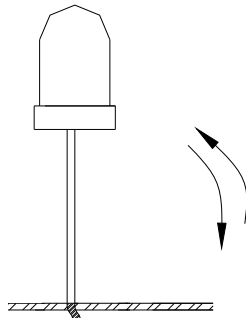

Fig.9

2) Tensile strength (@Room Temperature)

If the force is 1kg or less, there will be no problem. (Fig.10)

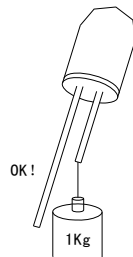

Fig.10

●HANDLING PRECAUTIONS

Although rigid against vibration, the LEDs may be damaged or scratched if dropped. So take care when handling.

●CHEMICAL RESISTANCE

- 1) Avoid exposure to chemicals as it may attack the LED surface and cause discoloration.
- 2) When washing is required, refer to the following table for the proper chemical to be used.
(Immersion time: within 3 minutes at room temperature.)

SOLVENT	ADAPTABILITY
Freon TE	⊙
Chloroethene	✕
Isopropyl Alcohol	⊙
Thinner	✕
Acetone	✕
Trichloroethylene	✕

⊙--Usable ✕--Do not use.

NOTE: Influences of ultrasonic cleaning of the LED resin body differ depending on such factors as the oscillator output, size of the PC board and the way in which the LED is mounted. Therefore, ultrasonic cleaning should only be performed after confirming there is no problem by conducting a test under practical.

5.0 mm DIA CYLINDRICAL LED LAMP

LRR5UW5C193G-YX

REV:A / 1

●OTHERS

- 1) Care must be taken to ensure that the reverse voltage will not exceed the absolute maximum rating when using the LEDs with matrix drive.
- 2) Flashing lights have been known to cause discomfort in people; you can prevent this by taking precautions during use. Also, people should be cautious when using equipment that has had LEDs incorporated into it.
- 3) The LEDs described in this brochure are intended to be used for ordinary electronic equipment (such as office equipment, communications equipment, measurement instruments and household appliances). Consult PARA's sales staff in advance for information on the applications in which exceptional quality and reliability are required , particularly when the failure or malfunction of the LEDs may directly jeopardize life or health (such as for airplanes, aerospace, submersible repeaters, nuclear reactor control systems, automobiles, traffic control equipment, life support systems and safety devices).
- 4) User shall not reverse engineer by disassembling or analysis of the LEDs without having prior written consent from PARA. When defective LEDs are found, the User shall inform PARA directly before disassembling or analysis.
- 5) The formal specifications must be exchanged and signed by both parties before large volume purchase begins.
- 6) The appearance and specifications of the product may be modified for improvement without notice.

5.0 mm DIA CYLINDRICAL LED LAMP

LRR5UW5C193G-YX

REV:A / 1

Bin code list

Forward Voltage (VF), Unit:v@20mA		
Bin Code	Min	Max
V0	2.8	3.0
V1	3.0	3.2
V2	3.2	3.4

Luminous Intensity(IV), Unit:mcd@20mA		
Bin Code	Min	Max
IB	1810	2110
JA	2110	2530
JB	2530	2950
KA	2950	3540
KB	3540	4130

	WA4					WA5			
X	0.25	0.25	0.26	0.26	X	0.26	0.26	0.264	0.28
Y	0.19	0.25	0.265	0.205	Y	0.205	0.265	0.267	0.248
	A0					B11			
X	0.28	0.264	0.283	0.296	X	0.287	0.283	0.31	0.31
Y	0.248	0.267	0.305	0.276	Y	0.295	0.305	0.335	0.318
	B12								
X	0.31	0.31	0.33	0.33					
Y	0.318	0.335	0.36	0.339					