

Low-Power Operational Amplifier

Features

- Small Footprint SOT-23-5 Package
- Guaranteed 2.7V, 3V, 5V, and 12V Performance
- 500 kHz Gain-Bandwidth
- 0.01% Total Harmonic Distortion at 10 kHz (5V, 2 k Ω)
- 0.5 mA Typical Supply Current at 5V

Applications

- Mobile Communications, Cellular Phones, Pagers
- Battery-Powered Instrumentation
- PCMCIA, USB
- Portable Computers and PDAs

General Description

The LMC7101 is a high-performance, low-power, operational amplifier that is pin-for-pin compatible with the National Semiconductor LMC7101. It features rail-to-rail input and output performance in the IttyBitty SOT-23-5 package.

The LMC7101 is a 500 kHz gain-bandwidth amplifier designed to operate from 2.7V to 12V single-ended power supplies with guaranteed performance at supply voltages of 2.7V, 3V, 5V, and 12V.

This op amp's input common-mode range includes ground and extends 300 mV beyond the supply rails. For example, the common-mode range is $-0.3V$ to $+5.3V$ with a 5V supply.

Package Type

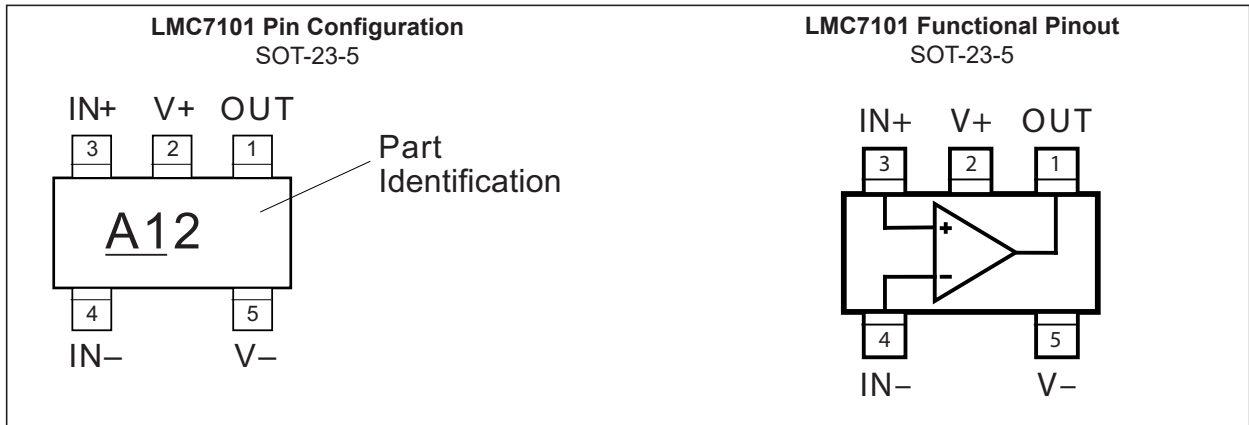

LMC7101

1.0 ELECTRICAL CHARACTERISTICS

Absolute Maximum Ratings † ††

Supply Voltage, ($V_{V+} - V_{V-}$)	+15V
Differential Input Voltage, ($V_{IN+} - V_{IN-}$)	$\pm(V_{V+} - V_{V-})$
I/O Pin Voltage, (V_{IN}, V_{OUT}) (Note 1)	$V_{V+} + 0.3V$ to $V_{V-} - 0.3V$
ESD Protection, (Note 2)	± 2 kV HBM

Operating Ratings††

Supply Voltage, $V_{IN} - V_{V-}$	2.7V to 12V
Max. Power Dissipation	(Note 3)

† Notice: Stresses above those listed under “Absolute Maximum Ratings” may cause permanent damage to the device. This is a stress rating only and functional operation of the device at those or any other conditions above those indicated in the operational sections of this specification is not intended. Exposure to maximum rating conditions for extended periods may affect device reliability.

†† Notice: Absolute maximum ratings indicate limits beyond which damage to the component may occur. Electrical specifications do not apply when operating the device outside its recommended operating ratings.

Note 1: I/O pin voltage is any external voltage to which an input or output is referenced.

2: Human body model, 1.5 k Ω in series with 100 pF.

3: The maximum allowable power dissipation is a function of the maximum junction temperature, $T_{J(max)}$; the junction-to-ambient thermal resistance, θ_{JA} ; and the ambient temperature, T_A . The maximum allowable power dissipation at any ambient temperature is calculated using: $P_D = (T_{J(max)} - T_A) \div \theta_{JA}$. Exceeding the maximum allowable power dissipation will result in excessive die temperature.

LM7101A 2.7V DC ELECTRICAL CHARACTERISTICS

Electrical Characteristics: Unless otherwise indicated, $V_+ = +2.7V$, $V_- = 0V$, $V_{CM} = V_{OUT} = V_+/2$; $R_L = 1\text{ M}\Omega$; $T_J = +25^\circ\text{C}$.

Parameters	Symbol	Min.	Typ.	Max.	Units	Conditions
Input Offset Voltage	V_{OS}	—	0.11	6	mV	—
Input Offset Voltage Average Drift	TCV_{OS}	—	1.0	—	$\mu\text{V}/^\circ\text{C}$	—
Input Bias Current	I_B	—	1.0	64	pA	$-40^\circ\text{C} \leq T_J \leq +85^\circ\text{C}$
Input Offset Current	I_{OS}	—	0.5	32		$-40^\circ\text{C} \leq T_J \leq +85^\circ\text{C}$
Input Resistance	R_{IN}	—	>1	—	T Ω	—
Common-Mode Rejection Ratio	CMRR	50	70	—	dB	$0V \leq V_{CM} \leq 2.7V$, Note 1
Input Common Mode Voltage	V_{CM}	—	-0.3	0.0	V	Input LOW, CMRR ≥ 50 dB
		2.7	3.0	—	V	Input HIGH, CMRR ≥ 50 dB
Power Supply Rejection Ratio	PSRR	50	60	—	dB	$V_+ = 1.35V$ to $1.65V$, $V_- = -1.35V$ to $-1.65V$, $V_{CM} = 0V$
Common-Mode Input Capacitance	C_{IN}	—	3	—	pF	—
Output Swing	V_O	2.64	2.699	—	V	Output HIGH, $R_L = 10\text{ k}\Omega$
		—	0.001	0.06	V	Output LOW, $R_L = 10\text{ k}\Omega$
		2.6	2.692	—	V	Output HIGH, $R_L = 2\text{ k}\Omega$
		—	0.008	0.1	V	Output LOW, $R_L = 2\text{ k}\Omega$
Supply Current	I_S	—	0.5	0.81	mA	—
		—	—	0.95	mA	$-40^\circ\text{C} \leq T_J \leq +85^\circ\text{C}$
Slew Rate	SR	—	0.4	—	V/ μs	—
Gain-Bandwidth Product	GBW	—	0.5	—	MHz	—

Note 1: Common-mode performance tends to follow the typical value. Minimum value limits reflect performance only near the supply rails.

LMC7101

LM7101B 2.7V DC ELECTRICAL CHARACTERISTICS

Electrical Characteristics: Unless otherwise indicated, $V_+ = +2.7V$, $V_- = 0V$, $V_{CM} = V_{OUT} = V_+/2$; $R_L = 1M\Omega$; $T_J = +25^\circ C$. **Bold** values indicate $-40^\circ C \leq T_J \leq +85^\circ C$.

Parameters	Symbol	Min.	Typ.	Max.	Units	Conditions
Input Offset Voltage	V_{OS}	—	0.11	9	mV	—
Input Offset Voltage Average Drift	TCV_{OS}	—	1.0	—	$\mu V/^\circ C$	—
Input Bias Current	I_B	—	1.0	64	pA	$-40^\circ C \leq T_J \leq +85^\circ C$
Input Offset Current	I_{OS}	—	0.5	32	pA	$-40^\circ C \leq T_J \leq +85^\circ C$
Input Resistance	R_{IN}	—	>1	—	$T\Omega$	—
Common-Mode Rejection Ratio	CMRR	50	70	—	dB	$0V \leq V_{CM} \leq 2.7V$, Note 1
Input Common Mode Voltage	V_{CM}	—	-0.3	0.0	V	Input LOW, CMRR ≥ 50 dB
		2.7	3.0	—	V	Input HIGH, CMRR ≥ 50 dB
Power Supply Rejection Ratio	PSRR	45	60	—	dB	$V_+ = 1.35V$ to $1.65V$, $V_- = -1.35V$ to $-1.65V$, $V_{CM} = 0V$
Common-Mode Input Capacitance	C_{IN}	—	3	—	pF	—
Output Swing	V_O	2.64	2.699	—	V	Output HIGH, $R_L = 10\text{ k}\Omega$
		—	0.001	0.06	V	Output LOW, $R_L = 10\text{ k}\Omega$
		2.6	2.692	—	V	Output HIGH, $R_L = 2\text{ k}\Omega$
		—	0.008	0.1	V	Output LOW, $R_L = 2\text{ k}\Omega$
Supply Current	I_S	—	0.5	0.81	mA	—
		—	—	0.95	mA	$-40^\circ C \leq T_J \leq +85^\circ C$
Slew Rate	SR	—	0.4	—	$V/\mu s$	—
Gain-Bandwidth Product	GBW	—	0.5	—	MHz	—

Note 1: Common-mode performance tends to follow the typical value. Minimum value limits reflect performance only near the supply rails.

LM7101A 3.0V DC ELECTRICAL CHARACTERISTICS

Electrical Characteristics: Unless otherwise indicated, $V_+ = +3.0V$, $V_- = 0V$, $V_{CM} = V_{OUT} = V_+/2$; $R_L = 1\text{ M}\Omega$; $T_J = +25^\circ\text{C}$.

Parameters	Symbol	Min.	Typ.	Max.	Units	Conditions
Input Offset Voltage	V_{OS}	—	0.11	4	mV	—
		—	0.11	6	mV	$-40^\circ\text{C} \leq T_J \leq +85^\circ\text{C}$
Input Offset Voltage Average Drift	TCV_{OS}	—	1.0	—	$\mu\text{V}/^\circ\text{C}$	—
Input Bias Current	I_B	—	1.0	64	pA	$-40^\circ\text{C} \leq T_J \leq +85^\circ\text{C}$
Input Offset Current	I_{OS}	—	0.5	32	pA	$-40^\circ\text{C} \leq T_J \leq +85^\circ\text{C}$
Input Resistance	R_{IN}	—	>1	—	$\text{T}\Omega$	—
Common-Mode Rejection Ratio	CMRR	60	74	—	dB	$0V \leq V_{CM} \leq 3.0V$, Note 1
Input Common Mode Voltage	V_{CM}	—	-0.3	0.0	V	Input LOW, CMRR ≥ 50 dB
		3.0	3.3	—	V	Input HIGH, CMRR ≥ 50 dB
Power Supply Rejection Ratio	PSRR	68	80	—	dB	$V_+ = 1.5V$ to $6.0V$, $V_- = -1.5V$ to $-6.0V$, $V_{CM} = 0V$
Common-Mode Input Capacitance	C_{IN}	—	3	—	pF	—
Output Swing	V_{OUT}	2.9	2.992	—	V	Output HIGH, $R_L = 2\text{ k}\Omega$
		—	0.008	0.1	V	Output LOW, $R_L = 2\text{ k}\Omega$
		2.85	2.973	—	V	Output HIGH, $R_L = 600\Omega$
		—	0.027	0.15	V	Output LOW, $R_L = 600\Omega$
Supply Current	I_S	—	0.5	0.81	mA	—
		—	—	0.95	mA	$-40^\circ\text{C} \leq T_J \leq +85^\circ\text{C}$

Note 1: Common-mode performance tends to follow the typical value. Minimum value limits reflect performance only near the supply rails.

LMC7101

LM7101B 3.0V DC ELECTRICAL CHARACTERISTICS

Electrical Characteristics: Unless otherwise indicated, $V_+ = +3.0V$, $V_- = 0V$, $V_{CM} = V_{OUT} = V_+/2$; $R_L = 1\text{ M}\Omega$; $T_J = +25^\circ\text{C}$.

Parameters	Symbol	Min.	Typ.	Max.	Units	Conditions
Input Offset Voltage	V_{OS}	—	0.11	7	mV	—
		—	0.11	9	mV	$-40^\circ\text{C} \leq T_J \leq +85^\circ\text{C}$
Input Offset Voltage Average Drift	TCV_{OS}	—	1.0	—	$\mu\text{V}/^\circ\text{C}$	—
Input Bias Current	I_B	—	1.0	64	pA	$-40^\circ\text{C} \leq T_J \leq +85^\circ\text{C}$
Input Offset Current	I_{OS}	—	0.5	32	pA	$-40^\circ\text{C} \leq T_J \leq +85^\circ\text{C}$
Input Resistance	R_{IN}	—	>1	—	$\text{T}\Omega$	—
Common-Mode Rejection Ratio	CMRR	60	74	—	dB	$0V \leq V_{CM} \leq 3.0V$, Note 1
Input Common Mode Voltage	V_{CM}	—	-0.3	0.0	V	Input LOW, CMRR ≥ 50 dB
		3.0	3.3	—	V	Input HIGH, CMRR ≥ 50 dB
Power Supply Rejection Ratio	PSRR	60	80	—	dB	$V_+ = 1.5V$ to $6.0V$, $V_- = -1.5V$ to $-6.0V$, $V_{CM} = 0$
Common-Mode Input Capacitance	C_{IN}	—	3	—	pF	—
Output Swing	V_O	2.9	2.992	—	V	Output HIGH, $R_L = 2\text{ k}\Omega$
		—	0.008	0.1	V	Output LOW, $R_L = 2\text{ k}\Omega$
		2.85	2.973	—	V	Output HIGH, $R_L = 600\Omega$
		—	0.027	0.15	V	Output LOW, $R_L = 600\Omega$
Supply Current	I_S	—	0.5	0.81	mA	—
		—	—	0.95	mA	$-40^\circ\text{C} \leq T_J \leq +85^\circ\text{C}$

Note 1: Common-mode performance tends to follow the typical value. Minimum value limits reflect performance only near the supply rails.

LM7101A 5.0V DC ELECTRICAL CHARACTERISTICS

Electrical Characteristics: Unless otherwise indicated, $V_+ = +5.0V$, $V_- = 0V$, $V_{CM} = 1.5V$, $V_{OUT} = V_+/2$; $R_L = 1\ M\Omega$; $T_J = +25^\circ C$.

Parameters	Symbol	Min.	Typ.	Max.	Units	Conditions
Input Offset Voltage	V_{OS}	—	0.11	3	mV	—
		—	0.11	5	mV	$-40^\circ C \leq T_J \leq +85^\circ C$
Input Offset Voltage Average Drift	TCV_{OS}	—	1.0	—	$\mu V/^\circ C$	—
Input Bias Current	I_B	—	1.0	64	pA	$-40^\circ C \leq T_J \leq +85^\circ C$
Input Offset Current	I_{OS}	—	0.5	32	pA	$-40^\circ C \leq T_J \leq +85^\circ C$
Input Resistance	R_{IN}	—	>1	—	$T\Omega$	—
Common-Mode Rejection Ratio	CMRR	60	82	—	dB	$0V \leq V_{CM} \leq 5V$, Note 1
		55	—	—	dB	$0V \leq V_{CM} \leq 5V$, Note 1 , $-40^\circ C \leq T_J \leq +85^\circ C$
Input Common Mode Voltage	V_{CM}	—	-0.3	-0.20	V	Input LOW, CMRR ≥ 50 dB
		—	—	0.00	V	Input LOW, CMRR ≥ 50 dB, $-40^\circ C \leq T_J \leq +85^\circ C$
		5.20	5.3	—	V	Input HIGH, CMRR ≥ 50 dB
		5.0	—	—	V	Input HIGH, CMRR ≥ 50 dB, $-40^\circ C \leq T_J \leq +85^\circ C$
Positive Power Supply Rejection Ratio	+PSRR	70	82	—	dB	$V_+ = 5V$ to 12V, $V_- = 0V$, $V_{OUT} = 1.5V$
		65	—	—	db	$V_+ = 5V$ to 12V, $V_- = 0V$, $V_{OUT} = 1.5V$, $-40^\circ C \leq T_J \leq +85^\circ C$
Negative Power Supply Rejection Ratio	-PSRR	70	82	—	dB	$V_+ = 0V$, $V_- = -5V$ to -12V, $V_{OUT} = -1.5V$
		65	—	—	dB	$V_+ = 0V$, $V_- = -5V$ to -12V, $V_{OUT} = -1.5V$, $-40^\circ C \leq T_J \leq +85^\circ C$
Common-Mode Input Capacitance	C_{IN}	—	3	—	pF	—

Note 1: Common-mode performance tends to follow the typical value. Minimum value limits reflect performance only near the supply rails.

2: Continuous short circuit may exceed absolute maximum T_J under some conditions.

LMC7101

LM7101A 5.0V DC ELECTRICAL CHARACTERISTICS (CONTINUED)

Electrical Characteristics: Unless otherwise indicated, $V_+ = +5.0V$, $V_- = 0V$, $V_{CM} = 1.5V$, $V_{OUT} = V_+/2$; $R_L = 1\text{ M}\Omega$; $T_J = +25^\circ\text{C}$.

Parameters	Symbol	Min.	Typ.	Max.	Units	Conditions
Output Swing	V_{OUT}	4.9	4.989	—	V	Output HIGH, $R_L = 2\text{ k}\Omega$
		4.85	—	—	V	Output HIGH, $R_L = 2\text{ k}\Omega$, $-40^\circ\text{C} \leq T_J \leq +85^\circ\text{C}$
		—	0.011	0.1	V	Output LOW, $R_L = 2\text{ k}\Omega$
		—	—	0.15	V	Output LOW, $R_L = 2\text{ k}\Omega$, $-40^\circ\text{C} \leq T_J \leq +85^\circ\text{C}$
		4.9	4.963	—	V	Output HIGH, $R_L = 600\Omega$
		4.8	—	—	V	Output HIGH, $R_L = 600\Omega$, $-40^\circ\text{C} \leq T_J \leq +85^\circ\text{C}$
		—	0.037	0.1	V	Output LOW, $R_L = 600\Omega$
		—	—	0.2	V	Output LOW, $R_L = 600\Omega$, $-40^\circ\text{C} \leq T_J \leq +85^\circ\text{C}$
Output Short Supply Current Note 2	I_{SC}	120	200	—	mA	Sourcing ($V_{OUT} = 0V$) or Sinking ($V_{OUT} = 5V$)
		80	—	—	mA	Sourcing ($V_{OUT} = 0V$) or Sinking ($V_{OUT} = 5V$), $-40^\circ\text{C} \leq T_J \leq +85^\circ\text{C}$
Supply Current	I_S	—	0.5	0.85	mA	—
		—	—	1.0	mA	$-40^\circ\text{C} \leq T_J \leq +85^\circ\text{C}$
<p>Note 1: Common-mode performance tends to follow the typical value. Minimum value limits reflect performance only near the supply rails.</p> <p>2: Continuous short circuit may exceed absolute maximum T_J under some conditions.</p>						

LM7101B 5.0V DC ELECTRICAL CHARACTERISTICS

Electrical Characteristics: Unless otherwise indicated, $V_+ = +5.0V$, $V_- = 0V$, $V_{CM} = 1.5V$, $V_{OUT} = V_+/2$; $R_L = 1\ M\Omega$; $T_J = +25^\circ C$.

Parameters	Symbol	Min.	Typ.	Max.	Units	Conditions
Input Offset Voltage	V_{OS}	—	0.11	7	mV	—
		—	0.11	9	mV	$-40^\circ C \leq T_J \leq +85^\circ C$
Input Offset Voltage Average Drift	TCV_{OS}	—	1.0	—	$\mu V/^\circ C$	—
Input Bias Current	I_B	—	1.0	64	pA	$-40^\circ C \leq T_J \leq +85^\circ C$
Input Offset Current	I_{OS}	—	0.5	32	pA	$-40^\circ C \leq T_J \leq +85^\circ C$
Input Resistance	R_{IN}	—	>1	—	$T\Omega$	—
Common-Mode Rejection Ratio	CMRR	60	82	—	dB	$0V \leq V_{CM} \leq 5V$, Note 1
		55	—	—	dB	$0V \leq V_{CM} \leq 5V$, Note 1 , $-40^\circ C \leq T_J \leq +85^\circ C$
Input Common Mode Voltage	V_{CM}	—	-0.3	-0.20	V	Input LOW, CMRR ≥ 50 dB
		—	—	0.00	V	Input LOW, CMRR ≥ 50 dB, $-40^\circ C \leq T_J \leq +85^\circ C$
		5.20	5.3	—	V	Input HIGH, CMRR ≥ 50 dB
		5.0	—	—	V	Input HIGH, CMRR ≥ 50 dB, $-40^\circ C \leq T_J \leq +85^\circ C$
Positive Power Supply Rejection Ratio	+PSRR	65	82	—	dB	$V_+ = 5V$ to 12V, $V_- = 0V$, $V_{OUT} = 1.5V$
		62	—	—	dB	$V_+ = 5V$ to 12V, $V_- = 0V$, $V_{OUT} = 1.5V$, $-40^\circ C \leq T_J \leq +85^\circ C$
Negative Power Supply Rejection Ratio	-PSRR	65	82	—	dB	$V_+ = 0V$, $V_- = -5V$ to -12V, $V_{OUT} = -1.5V$
		62	—	—	dB	$V_+ = 0V$, $V_- = -5V$ to -12V, $V_{OUT} = -1.5V$, $-40^\circ C \leq T_J \leq +85^\circ C$
Common-Mode Input Capacitance	C_{IN}	—	3	—	pF	—

Note 1: Common-mode performance tends to follow the typical value. Minimum value limits reflect performance only near the supply rails.

2: Continuous short circuit may exceed absolute maximum T_J under some conditions.

LMC7101

LM7101B 5.0V DC ELECTRICAL CHARACTERISTICS (CONTINUED)

Electrical Characteristics: Unless otherwise indicated, $V_+ = +5.0V$, $V_- = 0V$, $V_{CM} = 1.5V$, $V_{OUT} = V_+/2$; $R_L = 1\text{ M}\Omega$; $T_J = +25^\circ\text{C}$.

Parameters	Symbol	Min.	Typ.	Max.	Units	Conditions
Output Swing	V_{OUT}	4.9	4.989	—	V	Output HIGH, $R_L = 2\text{ k}\Omega$
		4.85	—	—	V	Output HIGH, $R_L = 2\text{ k}\Omega$, $-40^\circ\text{C} \leq T_J \leq +85^\circ\text{C}$
		—	0.011	0.1	V	Output LOW, $R_L = 2\text{ k}\Omega$
		—	—	0.15	V	Output LOW, $R_L = 2\text{ k}\Omega$, $-40^\circ\text{C} \leq T_J \leq +85^\circ\text{C}$
		4.9	4.963	—	V	Output HIGH, $R_L = 600\Omega$
		4.8	—	—	V	Output HIGH, $R_L = 600\Omega$, $-40^\circ\text{C} \leq T_J \leq +85^\circ\text{C}$
		—	0.037	0.1	V	Output LOW, $R_L = 600\Omega$
		—	—	0.2	V	Output LOW, $R_L = 600\Omega$, $-40^\circ\text{C} \leq T_J \leq +85^\circ\text{C}$
Output Short Supply Current Note 2	I_{SC}	120	200	—	mA	Sourcing ($V_{OUT} = 0V$) or Sinking ($V_{OUT} = 5V$)
		80	—	—	mA	Sourcing ($V_{OUT} = 0V$) or Sinking ($V_{OUT} = 5V$), $-40^\circ\text{C} \leq T_J \leq +85^\circ\text{C}$
Supply Current	I_S	—	0.5	0.85	mA	—
		—	—	1.0	mA	$-40^\circ\text{C} \leq T_J \leq +85^\circ\text{C}$
<p>Note 1: Common-mode performance tends to follow the typical value. Minimum value limits reflect performance only near the supply rails.</p> <p>2: Continuous short circuit may exceed absolute maximum T_J under some conditions.</p>						

LM7101A 12.0V DC ELECTRICAL CHARACTERISTICS

Electrical Characteristics: Unless otherwise indicated, $V_+ = +12V$, $V_- = 0V$, $V_{CM} = 1.5V$, $V_{OUT} = V_+/2$; $R_L = 1\text{ M}\Omega$; $T_J = +25^\circ\text{C}$.

Parameters	Symbol	Min.	Typ.	Max.	Units	Conditions
Input Offset Voltage	V_{OS}	—	0.11	6	mV	—
Input Offset Voltage Average Drift	TCV_{OS}	—	1.0	—	$\mu\text{V}/^\circ\text{C}$	—
Input Bias Current	I_B	—	1.0	64	pA	$-40^\circ\text{C} \leq T_J \leq +85^\circ\text{C}$
Input Offset Current	I_{OS}	—	0.5	32	pA	$-40^\circ\text{C} \leq T_J \leq +85^\circ\text{C}$
Input Resistance	R_{IN}	—	>1	—	$\text{T}\Omega$	—
Common-Mode Rejection Ratio	CMRR	65	82	—	dB	$0V \leq V_{CM} \leq 12V$, Note 1
		60	—	—	dB	$0V \leq V_{CM} \leq 12V$, Note 1 , $-40^\circ\text{C} \leq T_J \leq +85^\circ\text{C}$
Input Common Mode Voltage	V_{CM}	—	-0.3	-0.20	V	Input LOW, $V_+ = 12V$, CMRR $\geq 50\text{ dB}$
		—	—	0.00	V	Input LOW, $V_+ = 12V$, CMRR $\geq 50\text{ dB}$, $-40^\circ\text{C} \leq T_J \leq +85^\circ\text{C}$
		12.2	12.3	—	V	Input HIGH, $V_+ = 12V$, CMRR $\geq 50\text{ dB}$
		12.0	—	—	V	Input HIGH, $V_+ = 12V$, CMRR $\geq 50\text{ dB}$, $-40^\circ\text{C} \leq T_J \leq +85^\circ\text{C}$
Positive Power Supply Rejection Ratio	+PSRR	70	82	—	dB	$V_+ = 5V$ to $12V$, $V_- = 0V$, $V_{OUT} = 1.5V$
		65	—	—	dB	$V_+ = 5V$ to $12V$, $V_- = 0V$, $V_{OUT} = 1.5V$, $-40^\circ\text{C} \leq T_J \leq +85^\circ\text{C}$
Negative Power Supply Rejection Ratio	-PSRR	70	82	—	dB	$V_+ = 0V$, $V_- = -5V$ to $-12V$, $V_{OUT} = -1.5V$
		65	—	—	dB	$V_+ = 0V$, $V_- = -5V$ to $-12V$, $V_{OUT} = -1.5V$, $-40^\circ\text{C} \leq T_J \leq +85^\circ\text{C}$
Large Signal Voltage Gain	A_V	80	340	—	V/mV	Sourcing or sinking, $R_L = 2\text{k}\Omega$, Note 4
		40	—	—	V/mV	Sourcing or sinking, $R_L = 2\text{k}\Omega$, Note 4 , $-40^\circ\text{C} \leq T_J \leq +85^\circ\text{C}$
		15	300	—	V/mV	Sourcing or sinking, $R_L = 600\Omega$, Note 4
		10	—	—	V/mV	Sourcing or sinking, $R_L = 600\Omega$, Note 4 , $-40^\circ\text{C} \leq T_J \leq +85^\circ\text{C}$
Common-Mode Input Capacitance	C_{IN}	—	3	—	pF	—

Note 1: Common-mode performance tends to follow the typical value. Minimum value limits reflect performance only near the supply rails.

2: Continuous short circuit may exceed absolute maximum T_J under some conditions.

3: Shorting OUT to V_+ when $V_+ > 12V$ may damage the device.

4: R_L connected to $5.0V$. Sourcing: $5V \leq V_{OUT} \leq 12V$. Sinking: $2.5V \leq V_{OUT} \leq 5V$.

LMC7101

LM7101A 12.0V DC ELECTRICAL CHARACTERISTICS (CONTINUED)

Electrical Characteristics: Unless otherwise indicated, $V_+ = +12V$, $V_- = 0V$, $V_{CM} = 1.5V$, $V_{OUT} = V_+/2$; $R_L = 1\text{ M}\Omega$; $T_J = +25^\circ\text{C}$.

Parameters	Symbol	Min.	Typ.	Max.	Units	Conditions
Output Swing	V_{OUT}	11.9	11.98	—	V	Output HIGH, $V_+ = 12V$, $R_L = 2\text{ k}\Omega$
		11.87	—	—	V	Output HIGH, $V_+ = 12V$, $R_L = 2\text{ k}\Omega$, $-40^\circ\text{C} \leq T_J \leq +85^\circ\text{C}$
		—	0.02	0.10	V	Output LOW, $V_+ = 12V$, $R_L = 2\text{ k}\Omega$
		—	—	0.13	V	Output LOW, $V_+ = 12V$, $R_L = 2\text{ k}\Omega$, $-40^\circ\text{C} \leq T_J \leq +85^\circ\text{C}$
		11.73	11.93	—	V	Output HIGH, $V_+ = 12V$, $R_L = 600\Omega$
		11.65	—	—	V	Output HIGH, $V_+ = 12V$, $R_L = 600\Omega$, $-40^\circ\text{C} \leq T_J \leq +85^\circ\text{C}$
		—	0.07	0.27	V	Output LOW, $V_+ = 12V$, $R_L = 600\Omega$
		—	—	0.35	V	Output LOW, $V_+ = 12V$, $R_L = 600\Omega$, $-40^\circ\text{C} \leq T_J \leq +85^\circ\text{C}$
Output Short Supply Current Note 2	I_{SC}	200	300	—	mA	Sourcing ($V_{OUT} = 0V$) or Sinking ($V_{OUT} = 12V$), Note 2, 3
		120	—	—	mA	Sourcing ($V_{OUT} = 0V$) or Sinking ($V_{OUT} = 12V$), Note 2, 3, $-40^\circ\text{C} \leq T_J \leq +85^\circ\text{C}$
Supply Current	I_S	—	0.8	1.5	mA	—
		—	—	1.71	mA	$-40^\circ\text{C} \leq T_J \leq +85^\circ\text{C}$
<p>Note 1: Common-mode performance tends to follow the typical value. Minimum value limits reflect performance only near the supply rails.</p> <p>2: Continuous short circuit may exceed absolute maximum T_J under some conditions.</p> <p>3: Shorting OUT to V_+ when $V_+ > 12V$ may damage the device.</p> <p>4: R_L connected to 5.0V. Sourcing: $5V \leq V_{OUT} \leq 12V$. Sinking: $2.5V \leq V_{OUT} \leq 5V$.</p>						

LM7101B 12.0V DC ELECTRICAL CHARACTERISTICS

Electrical Characteristics: Unless otherwise indicated, $V_+ = +12V$, $V_- = 0V$, $V_{CM} = 1.5V$, $V_{OUT} = V_+/2$; $R_L = 1\text{ M}\Omega$; $T_J = +25^\circ\text{C}$.

Parameters	Symbol	Min.	Typ.	Max.	Units	Conditions
Input Offset Voltage	V_{OS}	—	0.11	9	mV	—
Input Offset Voltage Average Drift	TCV_{OS}	—	1.0	—	$\mu\text{V}/^\circ\text{C}$	—
Input Bias Current	I_B	—	1.0	64	pA	$-40^\circ\text{C} \leq T_J \leq +85^\circ\text{C}$
Input Offset Current	I_{OS}	—	0.5	32	pA	$-40^\circ\text{C} \leq T_J \leq +85^\circ\text{C}$
Input Resistance	R_{IN}	—	>1	—	$\text{T}\Omega$	—
Common-Mode Rejection Ratio	CMRR	65	82	—	dB	$0V \leq V_{CM} \leq 12V$, Note 1
		60	—	—	dB	$0V \leq V_{CM} \leq 12V$, Note 1 , $-40^\circ\text{C} \leq T_J \leq +85^\circ\text{C}$
Input Common Mode Voltage	V_{CM}	—	-0.3	-0.20	V	Input LOW, $V_+ = 12V$, CMRR $\geq 50\text{ dB}$
		—	—	0.00	V	Input LOW, $V_+ = 12V$, CMRR $\geq 50\text{ dB}$, $-40^\circ\text{C} \leq T_J \leq +85^\circ\text{C}$
		12.2	12.3	—	V	Input HIGH, $V_+ = 12V$, CMRR $\geq 50\text{ dB}$
		12.0	—	—	V	Input HIGH, $V_+ = 12V$, CMRR $\geq 50\text{ dB}$, $-40^\circ\text{C} \leq T_J \leq +85^\circ\text{C}$
Positive Power Supply Rejection Ratio	+PSRR	65	82	—	dB	$V_+ = 5V$ to $12V$, $V_- = 0V$, $V_{OUT} = 1.5V$
		62	—	—	db	$V_+ = 5V$ to $12V$, $V_- = 0V$, $V_{OUT} = 1.5V$, $-40^\circ\text{C} \leq T_J \leq +85^\circ\text{C}$
Negative Power Supply Rejection Ratio	-PSRR	65	82	—	dB	$V_+ = 0V$, $V_- = -5V$ to $-12V$, $V_{OUT} = -1.5V$
		62	—	—	dB	$V_+ = 0V$, $V_- = -5V$ to $-12V$, $V_{OUT} = -1.5V$, $-40^\circ\text{C} \leq T_J \leq +85^\circ\text{C}$
Large Signal Voltage Gain	A_V	80	340	—	V/mV	Sourcing or sinking, $R_L = 2\text{k}\Omega$, Note 4
		40	—	—	V/mV	Sourcing or sinking, $R_L = 2\text{k}\Omega$, Note 4 , $-40^\circ\text{C} \leq T_J \leq +85^\circ\text{C}$
		15	300	—	V/mV	Sourcing or sinking, $R_L = 600\Omega$, Note 4
		10	—	—	V/mV	Sourcing or sinking, $R_L = 600\Omega$, Note 4 , $-40^\circ\text{C} \leq T_J \leq +85^\circ\text{C}$
Common-Mode Input Capacitance	C_{IN}	—	3	—	pF	—

Note 1: Common-mode performance tends to follow the typical value. Minimum value limits reflect performance only near the supply rails.

2: Continuous short circuit may exceed absolute maximum T_J under some conditions.

3: Shorting OUT to V_+ when $V_+ > 12V$ may damage the device.

4: R_L connected to $5.0V$. Sourcing: $5V \leq V_{OUT} \leq 12V$. Sinking: $2.5V \leq V_{OUT} \leq 5V$.

LMC7101

LM7101B 12.0V DC ELECTRICAL CHARACTERISTICS (CONTINUED)

Electrical Characteristics: Unless otherwise indicated, $V_+ = +12V$, $V_- = 0V$, $V_{CM} = 1.5V$, $V_{OUT} = V_+/2$; $R_L = 1\text{ M}\Omega$; $T_J = +25^\circ\text{C}$.

Parameters	Symbol	Min.	Typ.	Max.	Units	Conditions
Output Swing	V_{OUT}	11.9	11.98	—	V	Output HIGH, $V_+ = 12V$, $R_L = 2\text{ k}\Omega$
		11.87	—	—	V	Output HIGH, $V_+ = 12V$, $R_L = 2\text{ k}\Omega$, $-40^\circ\text{C} \leq T_J \leq +85^\circ\text{C}$
		—	0.02	0.10	V	Output LOW, $V_+ = 12V$, $R_L = 2\text{ k}\Omega$
		—	—	0.13	V	Output LOW, $V_+ = 12V$, $R_L = 2\text{ k}\Omega$, $-40^\circ\text{C} \leq T_J \leq +85^\circ\text{C}$
		11.73	11.93	—	V	Output HIGH, $V_+ = 12V$, $R_L = 600\Omega$
		11.65	—	—	V	Output HIGH, $V_+ = 12V$, $R_L = 600\Omega$, $-40^\circ\text{C} \leq T_J \leq +85^\circ\text{C}$
		—	0.07	0.27	V	Output LOW, $V_+ = 12V$, $R_L = 600\Omega$
		—	—	0.35	V	Output LOW, $V_+ = 12V$, $R_L = 600\Omega$, $-40^\circ\text{C} \leq T_J \leq +85^\circ\text{C}$
Output Short Supply Current Note 2	I_{SC}	200	300	—	mA	Sourcing ($V_{OUT} = 0V$) or Sinking ($V_{OUT} = 12V$), Note 2, 3
		120	—	—	mA	Sourcing ($V_{OUT} = 0V$) or Sinking ($V_{OUT} = 12V$), Note 2, 3, $-40^\circ\text{C} \leq T_J \leq +85^\circ\text{C}$
Supply Current	I_S	—	0.8	1.5	mA	—
		—	—	1.71	mA	$-40^\circ\text{C} \leq T_J \leq +85^\circ\text{C}$

Note 1: Common-mode performance tends to follow the typical value. Minimum value limits reflect performance only near the supply rails.

2: Continuous short circuit may exceed absolute maximum T_J under some conditions.

3: Shorting OUT to V_+ when $V_+ > 12V$ may damage the device.

4: R_L connected to 5.0V. Sourcing: $5V \leq V_{OUT} \leq 12V$. Sinking: $2.5V \leq V_{OUT} \leq 5V$.

LM7101A 5.0V AC ELECTRICAL CHARACTERISTICS

Electrical Characteristics: Unless otherwise indicated, $V_+ = +5V$, $V_- = 0V$, $V_{CM} = 1.5V$, $V_{OUT} = V_+/2$; $R_L = 1\text{ M}\Omega$; $T_J = +25^\circ\text{C}$.

Parameters	Symbol	Min.	Typ.	Max.	Units	Conditions
Total Harmonic Distortion	THD	—	0.01	—	%	$f = 10\text{ kHz}$, $A_V = -2$, $R_L = 2\text{ k}\Omega$, $V_{OUT} = 4.0\text{ V}_{PP}$
Slew Rate	SR	—	0.3	—	V/ μs	—
Gain Bandwidth Product	GBW	—	0.5	—	MHz	—

LM7101B 5.0V AC ELECTRICAL CHARACTERISTICS

Electrical Characteristics: Unless otherwise indicated, $V_+ = +5V$, $V_- = 0V$, $V_{CM} = 1.5V$, $V_{OUT} = V_+/2$; $R_L = 1\text{ M}\Omega$; $T_J = +25^\circ\text{C}$.

Parameters	Symbol	Min.	Typ.	Max.	Units	Conditions
Total Harmonic Distortion	THD	—	0.01	—	%	$f = 10\text{ kHz}$, $A_V = -2$, $R_L = 2\text{ k}\Omega$, $V_{OUT} = 4.0\text{ V}_{PP}$
Slew Rate	SR	—	0.3	—	$\text{V}/\mu\text{s}$	—
Gain Bandwidth Product	GBW	—	0.5	—	MHz	—

LM7101A 12.0V AC ELECTRICAL CHARACTERISTICS

Electrical Characteristics: Unless otherwise indicated, $V_+ = +12V$, $V_- = 0V$, $V_{CM} = 1.5V$, $V_{OUT} = V_+/2$; $R_L = 1\text{ M}\Omega$; $T_J = +25^\circ\text{C}$.

Parameters	Symbol	Min.	Typ.	Max.	Units	Conditions
Total Harmonic Distortion	THD	—	0.01	—	%	$f = 10\text{ kHz}$, $A_V = -2$, $R_L = 2\text{ k}\Omega$, $V_{OUT} = 8.5\text{ V}_{PP}$
Slew Rate	SR	0.19	0.3	—	$\text{V}/\mu\text{s}$	$V_+ = 12V$, Note 1
		0.15	—	—	$\text{V}/\mu\text{s}$	$V_+ = 12V$, Note 1 , $-40^\circ\text{C} \leq T_J \leq +85^\circ\text{C}$
Gain-Bandwidth Product	GBW	—	0.5	—	MHz	—
Phase Margin	Φ_m	—	45	—	$^\circ$	—
Gain Margin	G_m	—	10	—	dB	—
Input-Referred Voltage Noise	e_n	—	37	—	$nV/\sqrt{\text{Hz}}$	$f = 1\text{ kHz}$, $V_{CM} = 1V$
Input-Referred Current Noise	i_n	—	1.5	—	$fA/\sqrt{\text{Hz}}$	$f = 1\text{ kHz}$

Note 1: Device connected as a voltage follower with a 12V step input. The value is the positive or negative slew rate, whichever is slower.

LMC7101

LM7101B 12.0V AC ELECTRICAL CHARACTERISTICS

Electrical Characteristics: Unless otherwise indicated, $V_+ = +12V$, $V_- = 0V$, $V_{CM} = 1.5V$, $V_{OUT} = V_+/2$; $R_L = 1M\Omega$; $T_J = +25^\circ C$.

Parameters	Symbol	Min.	Typ.	Max.	Units	Conditions
Total Harmonic Distortion	THD	—	0.01	—	%	$f = 10\text{ kHz}$, $A_V = -2$, $R_L = 2\text{ k}\Omega$, $V_{OUT} = 8.5\text{ V}_{PP}$
Slew Rate	SR	0.19	0.3	—	$V/\mu s$	$V_+ = 12V$, Note 1
		0.15	—	—	$V/\mu s$	$V_+ = 12V$, Note 1 , $-40^\circ C \leq T_J \leq +85^\circ C$
Gain-Bandwidth Product	GBW	—	0.5	—	MHz	—
Phase Margin	Φ_m	—	45	—	$^\circ$	—
Gain Margin	G_m	—	10	—	dB	—
Input-Referred Voltage Noise	e_n	—	37	—	nV/\sqrt{Hz}	$f = 1\text{ kHz}$, $V_{CM} = 1V$
Input-Referred Current Noise	i_n	—	1.5	—	fA/\sqrt{Hz}	$f = 1\text{ kHz}$

Note 1: Device connected as a voltage follower with a 12V step input. The value is the positive or negative slew rate, whichever is slower.

TEMPERATURE SPECIFICATIONS ([Note 1](#))

Parameters	Sym.	Min.	Typ.	Max.	Units	Conditions
Temperature Ranges						
Operating Ambient Temperature Range	T_A	-40	—	+85	$^\circ C$	—
Junction Operating Temperature	T_J	-40	—	+125	$^\circ C$	—
Max. Junction Operating Temperature	$T_{J(max)}$	—	—	+125	$^\circ C$	—
Storage Temperature Range	T_A	-65	—	+150	$^\circ C$	—
Package Thermal Resistances						
Thermal Resistance	θ_{JA}	—	325	—	$^\circ C/W$	—

Note 1: Absolute maximum ratings indicate limits beyond which damage to the component may occur. Electrical specifications do not apply when operating the device outside its recommended operating ratings.

2.0 TYPICAL PERFORMANCE CURVES

Note: The graphs and tables provided following this note are a statistical summary based on a limited number of samples and are provided for informational purposes only. The performance characteristics listed herein are not tested or guaranteed. In some graphs or tables, the data presented may be outside the specified operating range (e.g., outside specified power supply range) and therefore outside the warranted range.

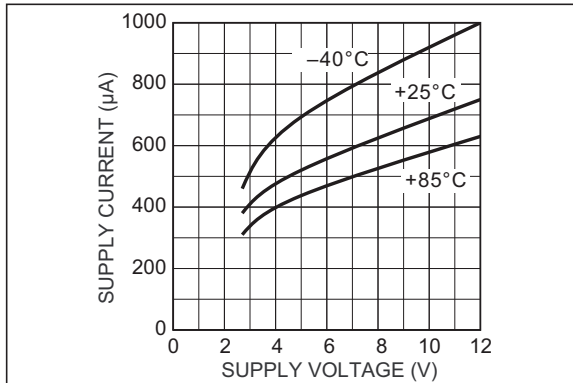

FIGURE 2-1: Supply Current vs. Supply Voltage.

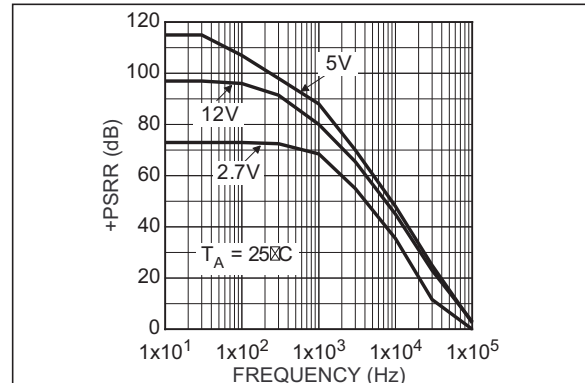

FIGURE 2-4: +PSRR vs. Frequency.

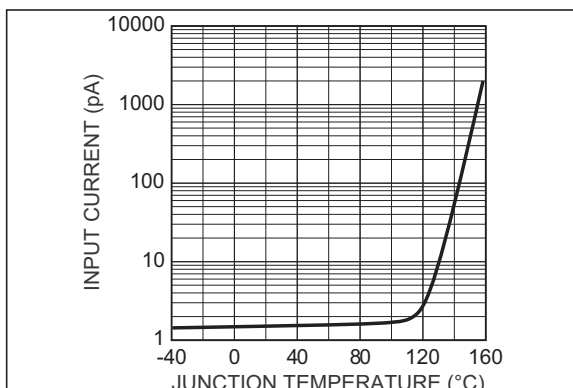

FIGURE 2-2: Input Current vs. Junction Temperature.

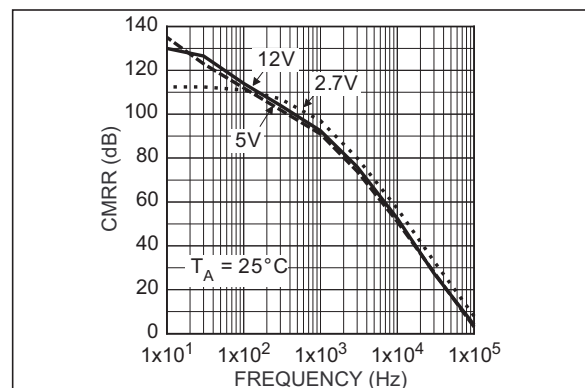

FIGURE 2-5: CMRR vs. Frequency.

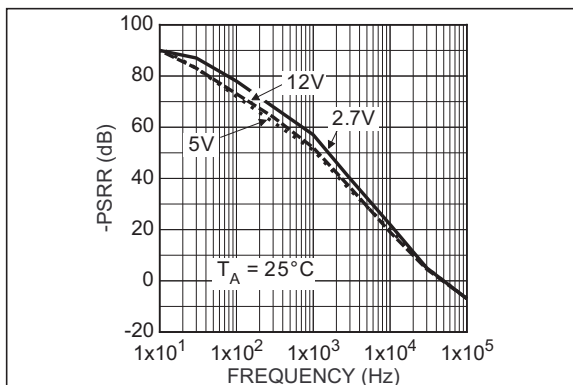

FIGURE 2-3: -PSRR vs. Frequency.

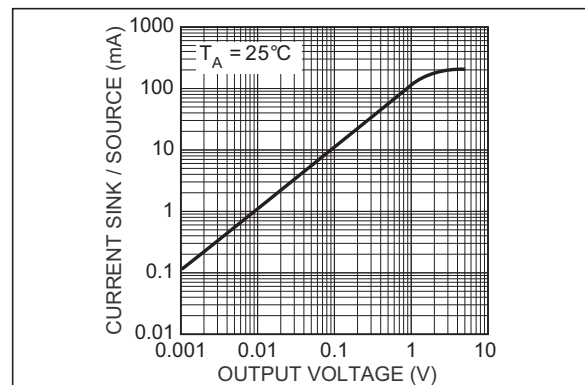

FIGURE 2-6: Sink/Source Current vs. Output Voltage.

LMC7101

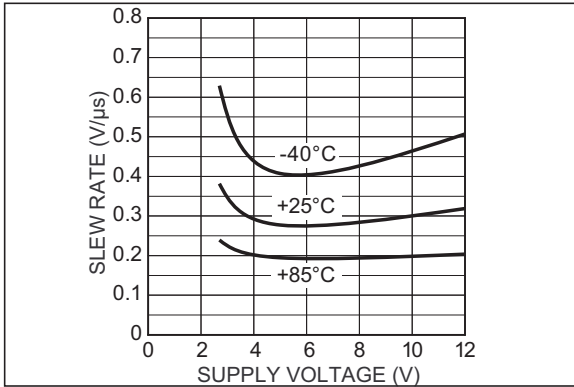

FIGURE 2-7: Falling Slew Rate vs. Supply Voltage.

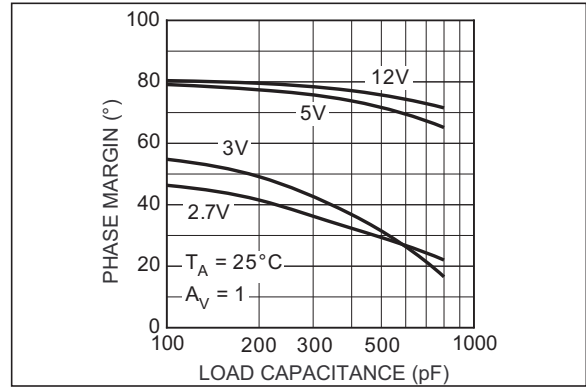

FIGURE 2-10: Phase Margin vs. Capacitance Load.

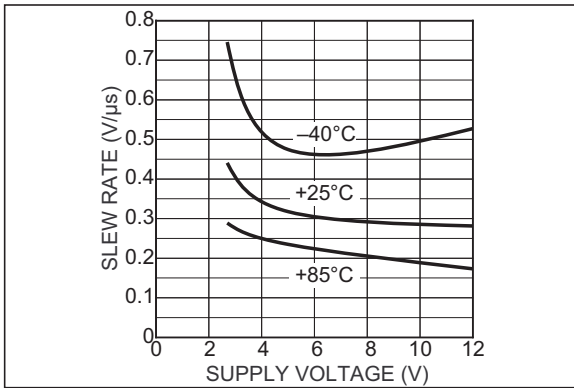

FIGURE 2-8: Rising Slew Rate vs. Supply Voltage.

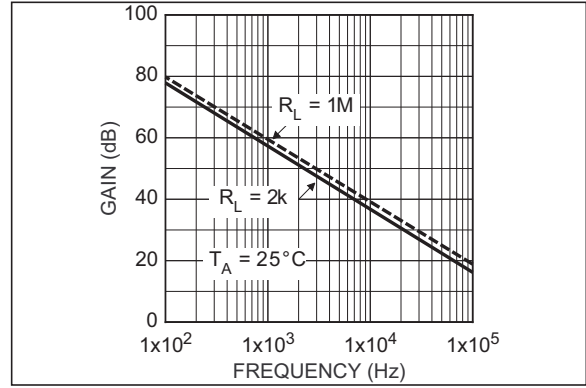

FIGURE 2-11: 2.7V Open-Loop Frequency Response.

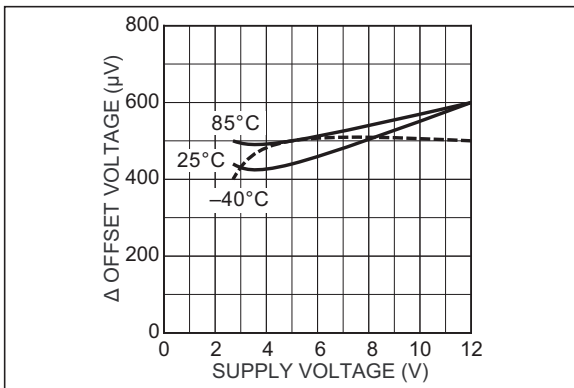

FIGURE 2-9: Offset Voltage vs. Supply Voltage.

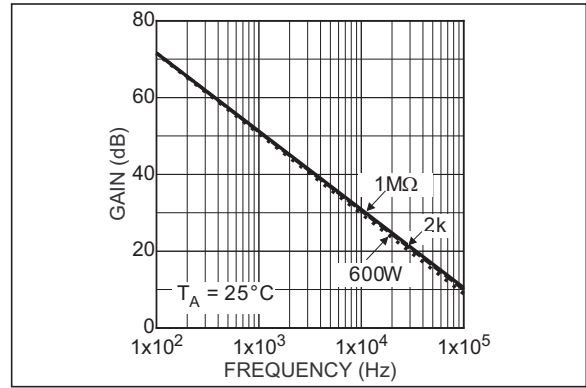

FIGURE 2-12: 5V Open-Loop Frequency Response.

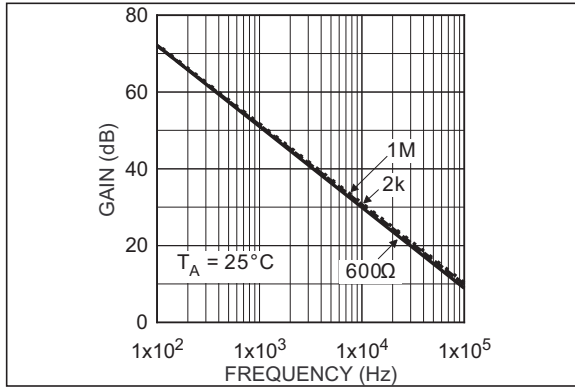

FIGURE 2-13: 12V Open-Loop Frequency Response.

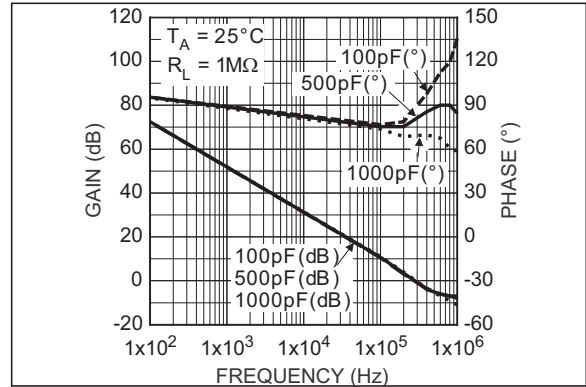

FIGURE 2-16: 12V Open-Loop Gain and Phase.

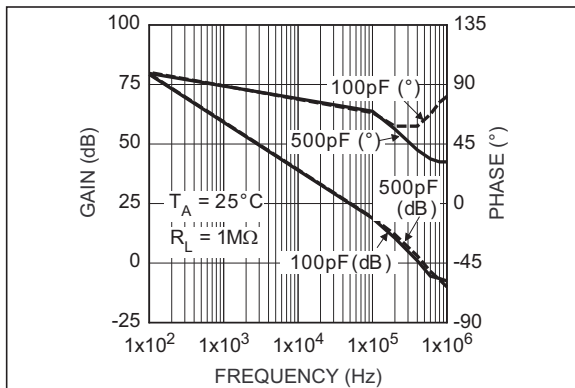

FIGURE 2-14: 2.7V Open-Loop Gain and Phase.

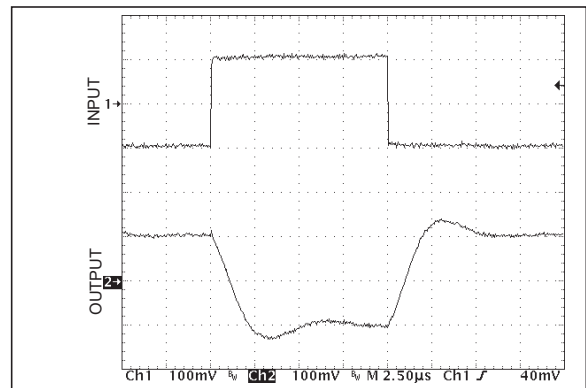

FIGURE 2-17: Inverting Small-Signal Pulse Response.

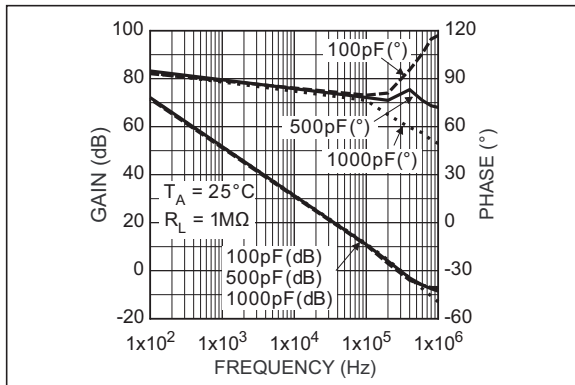

FIGURE 2-15: 5V Open-Loop Gain and Phase.

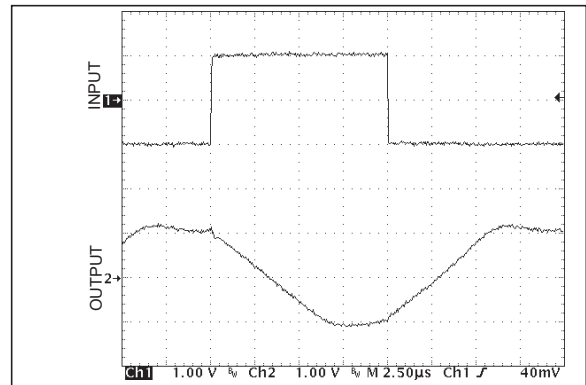

FIGURE 2-18: Inverting Large-Signal Pulse Response.

LMC7101

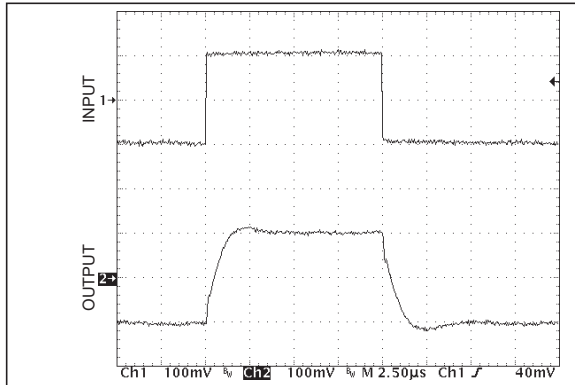

FIGURE 2-19: Non-Inverting Small-Signal Pulse Response.

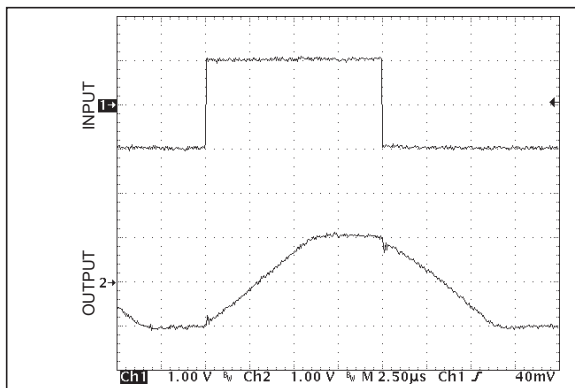

FIGURE 2-20: Non-Inverting Large-Signal Pulse Response.

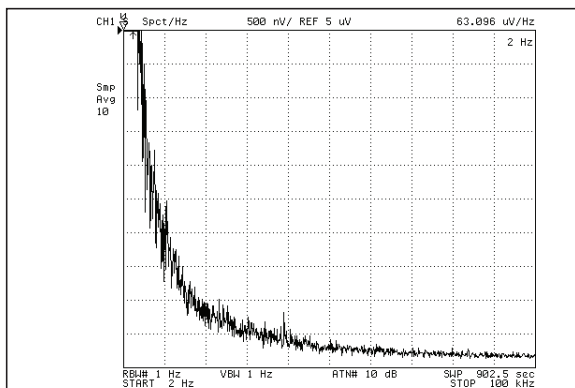

FIGURE 2-21: Input Voltage Noise vs. Frequency.

3.0 PIN DESCRIPTIONS

The descriptions of the pins are listed in [Table 3-1](#).

TABLE 3-1: PIN FUNCTION TABLE

Pin Number	Symbol	Description
1	OUT	Amplifier Output
2	V+	Positive Supply
3	IN+	Non-Inverting Input
4	IN-	Inverting Input
5	V-	Negative Supply: Negative supply for split-supply application or ground for single-supply application.

LMC7101

4.0 APPLICATION INFORMATION

4.1 Input Common-Mode Voltage

Some amplifiers exhibit undesirable or unpredictable performance when the inputs are driven beyond the common-mode voltage range; for example, phase inversion of the output signal. The LMC7101 tolerates input overdrive by at least 200 mV beyond either rail without producing phase inversion.

If the absolute maximum input voltage (700 mV beyond either rail) is exceeded, the input current should be limited to ± 5 mA maximum to prevent reducing reliability. A 10 k Ω series input resistor, used as a current limiter, will protect the input structure from voltages as large as 50V above the supply or below ground. See Figure 4-1.

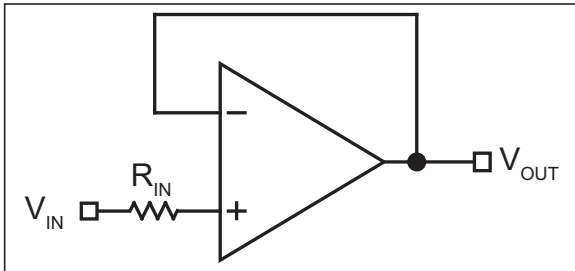

FIGURE 4-1: Input Current-Limit Protection.

4.2 Output Voltage Swing

Sink and source output resistances of the LMC7101 are equal. Maximum output voltage swing is determined by the load and the approximate output resistance. To calculate the output resistance, use Equation 4-1:

EQUATION 4-1:

$$R_{OUT} = \frac{V_{DROP}}{I_{LOAD}}$$

V_{DROP} is the voltage dropped within the amplifier output stage. V_{DROP} and I_{LOAD} can be determined from the V_O (output swing) portion of the appropriate [Electrical Characteristics](#) table. I_{LOAD} is equal to the typical output high voltage minus $V+/2$ and divided by R_{LOAD} . For example, using the [LM7101A 5.0V DC Electrical Characteristics](#) table, the typical output high voltage using a 2 k Ω load (connected to $V+/2$) is 4.989V, which produces an I_{LOAD} of:

EQUATION 4-2:

$$1.245mA \times \left(\frac{4.989V - 2.5V}{2k\Omega} \right) = 1.245mA$$

Voltage drop in the amplifier output stage is:

$$V_{DROP} = 5.0V - 4.989V$$

$$V_{DROP} = 0.011V$$

Because of output stage symmetry, the corresponding typical output low voltage (0.011V) also equals V_{DROP} .

EQUATION 4-3:

$$R_{OUT} = \frac{0.011V}{0.001245A} = 8.8 \approx 9\Omega$$

4.3 Driving Capacitive Loads

Driving a capacitive load introduces phase-lag into the output signal, and this in turn reduces op-amp system phase margin. The application that is least forgiving of reduced phase margin is a unity gain amplifier. The LMC7101 can typically drive a 100 pF capacitive load connected directly to the output when configured as a unity-gain amplifier.

4.4 Using Large-Value Feedback Resistors

A large-value feedback resistor (> 500 k Ω) can reduce the phase margin of a system. This occurs when the feedback resistor acts in conjunction with input capacitance to create phase lag in the feedback signal. Input capacitance is usually a combination of input circuit components and other parasitic capacitance, such as amplifier input capacitance and stray printed circuit board capacitance.

Figure 4-2 illustrates a method of compensating phase lag caused by using a large-value feedback resistor. Feedback capacitor C_{FB} introduces sufficient phase lead to overcome the phase lag caused by feedback resistor R_{FB} and input capacitance C_{IN} . The value of C_{FB} is determined by first estimating C_{IN} and then applying the following formula from Equation 4-4:

EQUATION 4-4:

$$R_{IN} \times C_{IN} \leq R_{FB} \times C_{FB}$$

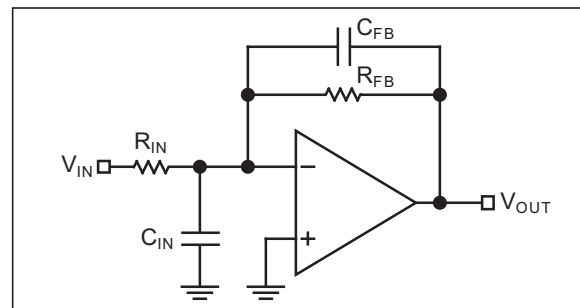

FIGURE 4-2: Canceling Feedback Phase Lag.

Since a significant percentage of C_{IN} may be caused by board layout, it is important to note that the correct value of C_{FB} may change when changing from a breadboard to the final circuit layout.

4.5 Typical Circuits

Some suitable LMC7101 single-supply, rail-to-rail applications are shown in the following circuit diagrams.

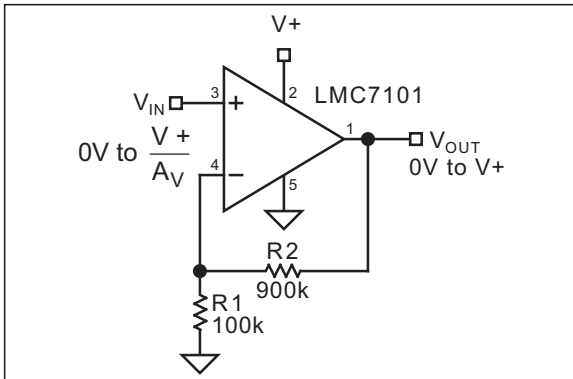

FIGURE 4-3: Non-Inverting Amplifier.

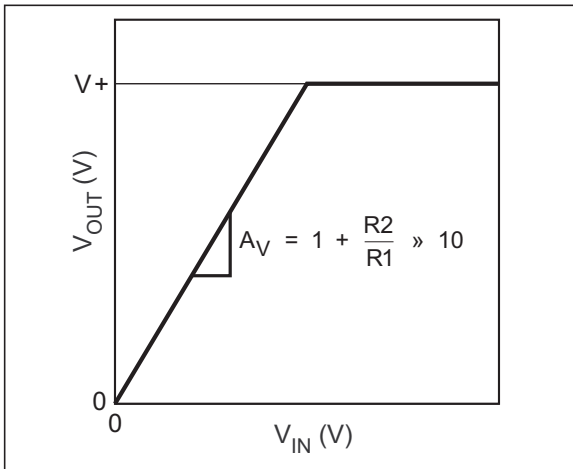

FIGURE 4-4: Non-Inverting Amplifier Behavior.

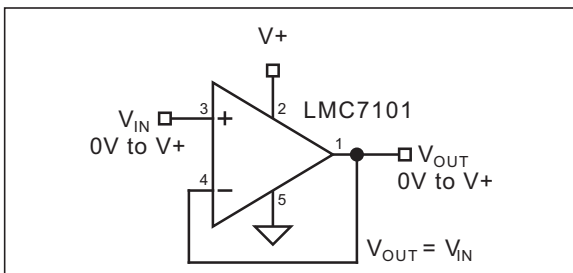

FIGURE 4-5: Voltage Follower.

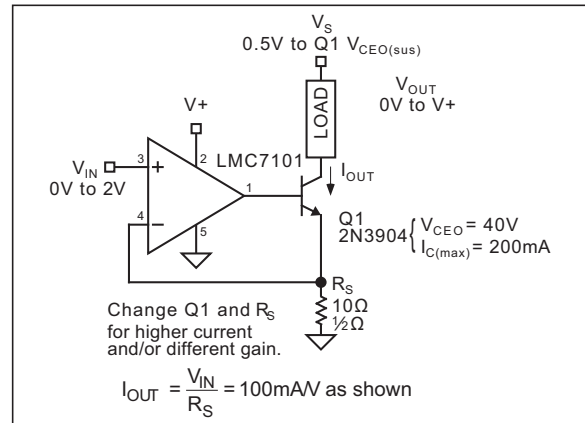

FIGURE 4-6: Voltage-Controlled Current Sink.

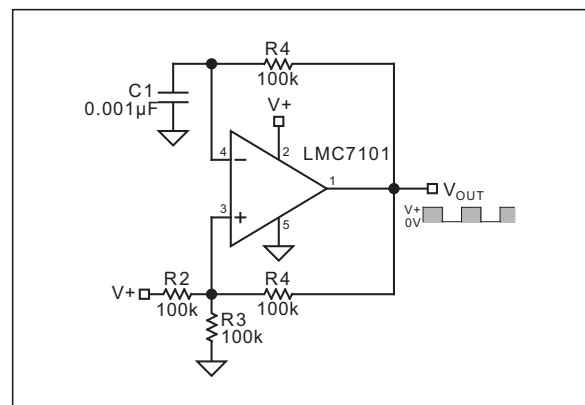

FIGURE 4-7: Square Wave Oscillator.

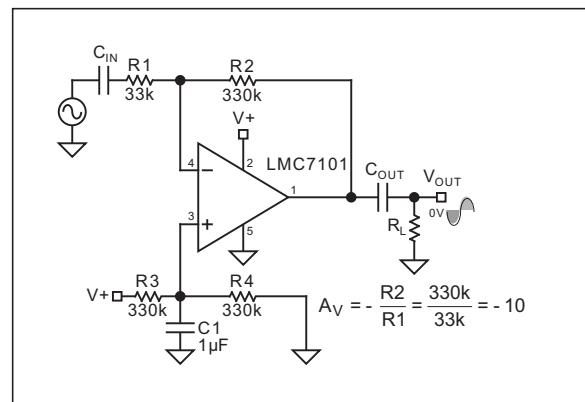

FIGURE 4-8: AC-Coupled Inverting Amplifier.

LMC7101

5.0 PACKAGING INFORMATION

5.1 Package Marking Information

5-Lead SOT-23*

Example

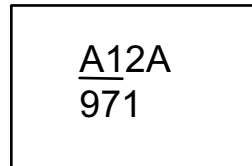
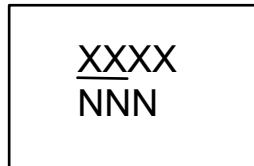

TABLE 5-1: MARKING CODES

Device	Marking Code
LMC7101A	<u>A12A</u>
LMC7101B	<u>A12</u>

<p>Legend: XX...X Product code or customer-specific information Y Year code (last digit of calendar year) YY Year code (last 2 digits of calendar year) WW Week code (week of January 1 is week '01') NNN Alphanumeric traceability code (e3) Pb-free JEDEC® designator for Matte Tin (Sn) * This package is Pb-free. The Pb-free JEDEC designator ((e3)) can be found on the outer packaging for this package. •, ▲, ▼ Pin one index is identified by a dot, delta up, or delta down (triangle mark).</p>
<p>Note: In the event the full Microchip part number cannot be marked on one line, it will be carried over to the next line, thus limiting the number of available characters for customer-specific information. Package may or may not include the corporate logo. Underbar (<u> </u>) and/or Overbar ($\bar{$) symbol may not be to scale.</p>

5-Lead SOT-23 Package Outline and Recommended Land Pattern

TITLE

5 LEAD SOT23 PACKAGE OUTLINE & RECOMMENDED LAND PATTERN

DRAWING #	SOT23-5LD-PL-1	UNIT	MM
------------------	----------------	-------------	----

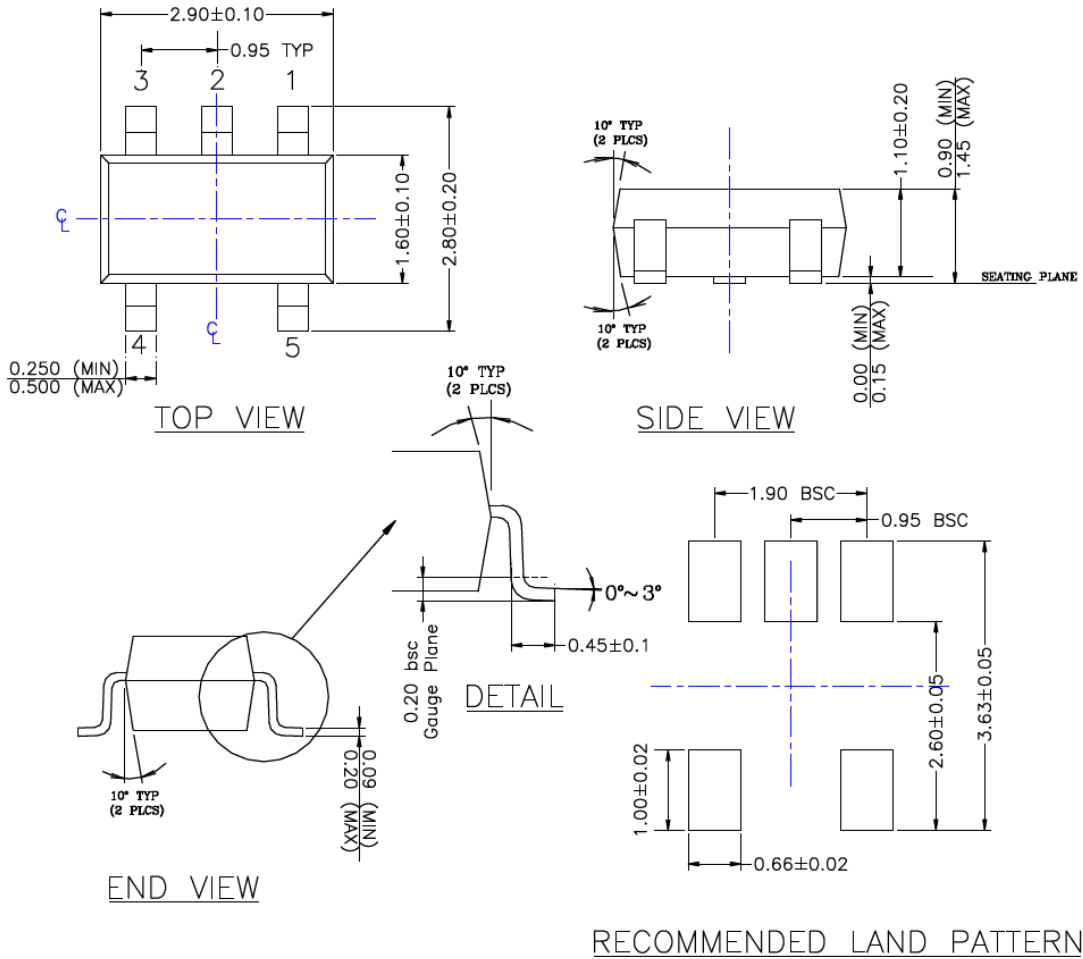

NOTE:

1. PACKAGE OUTLINE EXCLUSIVE OF MOLD FLASH & BURR.
2. PACKAGE OUTLINE INCLUSIVE OF SOLER PLATING.
3. DIMENSION AND TOLERANCE PER ANSI Y14.5M, 1982.
4. FOOT LENGTH MEASUREMENT BASED ON GAUGE PLANE METHOD.
5. DIE FACES UP FOR MOLD, AND FACES DOWN FOR TRIM/FORM.
6. ALL DIMENSIONS ARE IN MILLIMETERS.

Note: For the most current package drawings, please see the Microchip Packaging Specification located at <http://www.microchip.com/packaging>.

LMC7101

NOTES:

APPENDIX A: REVISION HISTORY

Revision A (December 2019)

- Converted Micrel document LMC7101 to Microchip data sheet template DS20006282A.
- Minor grammatical text changes throughout.

MCP1711

NOTES:

PRODUCT IDENTIFICATION SYSTEM

To order or obtain information, e.g., on pricing or delivery, contact your local Microchip representative or sales office.

<u>PART NO.</u>		<u>X</u>	<u>XX</u>	<u>-XX</u>
Device		Temperature Range	Package	Media Type
Device:	LMC7101A: Low-Power Operational Amplifier, A Grade LMC7101B: Low-Power Operational Amplifier, B Grade			
Temperature Range:	Y = -40°C to +85°C			
Packages:	M5 = 5-Lead SOT-23			
Media Type:	TR = 3,000/Reel			

Examples:

a) LMC7101AYM5-TR: Low-Power Operational Amplifier, A Grade, -40°C to +85°C Temperature Range, 5-Lead SOT-23, 3,000/Reel

b) LMC7101BYM5-TR: Low-Power Operational Amplifier, B Grade, -40°C to +85°C Temperature Range, 5-Lead SOT-23, 3,000/Reel

Note 1: Tape and Reel identifier only appears in the catalog part number description. This identifier is used for ordering purposes and is not printed on the device package. Check with your Microchip Sales Office for package availability with the Tape and Reel option.

LMC7101

NOTES:

Note the following details of the code protection feature on Microchip devices:

- Microchip products meet the specification contained in their particular Microchip Data Sheet.
- Microchip believes that its family of products is one of the most secure families of its kind on the market today, when used in the intended manner and under normal conditions.
- There are dishonest and possibly illegal methods used to breach the code protection feature. All of these methods, to our knowledge, require using the Microchip products in a manner outside the operating specifications contained in Microchip's Data Sheets. Most likely, the person doing so is engaged in theft of intellectual property.
- Microchip is willing to work with the customer who is concerned about the integrity of their code.
- Neither Microchip nor any other semiconductor manufacturer can guarantee the security of their code. Code protection does not mean that we are guaranteeing the product as “unbreakable.”

Code protection is constantly evolving. We at Microchip are committed to continuously improving the code protection features of our products. Attempts to break Microchip's code protection feature may be a violation of the Digital Millennium Copyright Act. If such acts allow unauthorized access to your software or other copyrighted work, you may have a right to sue for relief under that Act.

Information contained in this publication regarding device applications and the like is provided only for your convenience and may be superseded by updates. It is your responsibility to ensure that your application meets with your specifications. MICROCHIP MAKES NO REPRESENTATIONS OR WARRANTIES OF ANY KIND WHETHER EXPRESS OR IMPLIED, WRITTEN OR ORAL, STATUTORY OR OTHERWISE, RELATED TO THE INFORMATION, INCLUDING BUT NOT LIMITED TO ITS CONDITION, QUALITY, PERFORMANCE, MERCHANTABILITY OR FITNESS FOR PURPOSE. Microchip disclaims all liability arising from this information and its use. Use of Microchip devices in life support and/or safety applications is entirely at the buyer's risk, and the buyer agrees to defend, indemnify and hold harmless Microchip from any and all damages, claims, suits, or expenses resulting from such use. No licenses are conveyed, implicitly or otherwise, under any Microchip intellectual property rights unless otherwise stated.

Trademarks

The Microchip name and logo, the Microchip logo, Adaptec, AnyRate, AVR, AVR logo, AVR Freaks, BesTime, BitCloud, chipKIT, chipKIT logo, CryptoMemory, CryptoRF, dsPIC, FlashFlex, flexPWR, HELDO, IGLOO, JukeBlox, KeeLoq, Klear, LANCheck, LinkMD, maXStylus, maXTouch, MediaLB, megaAVR, Microsemi, Microsemi logo, MOST, MOST logo, MPLAB, OptoLyzer, PackeTime, PIC, picoPower, PICSTART, PIC32 logo, PolarFire, Prochip Designer, QTouch, SAM-BA, SenGenuity, SpyNIC, SST, SST Logo, SuperFlash, Symmetricom, SyncServer, Tachyon, TempTrackr, TimeSource, tinyAVR, UNI/O, Vectron, and XMEGA are registered trademarks of Microchip Technology Incorporated in the U.S.A. and other countries.

APT, ClockWorks, The Embedded Control Solutions Company, EtherSynch, FlashTec, Hyper Speed Control, HyperLight Load, IntelliMOS, Libero, motorBench, mTouch, Powermite 3, Precision Edge, ProASIC, ProASIC Plus, ProASIC Plus logo, Quiet-Wire, SmartFusion, SyncWorld, Temux, TimeCesium, TimeHub, TimePictra, TimeProvider, Vite, WinPath, and ZL are registered trademarks of Microchip Technology Incorporated in the U.S.A.

Adjacent Key Suppression, AKS, Analog-for-the-Digital Age, Any Capacitor, AnyIn, AnyOut, BlueSky, BodyCom, CodeGuard, CryptoAuthentication, CryptoAutomotive, CryptoCompanion, CryptoController, dsPICDEM, dsPICDEM.net, Dynamic Average Matching, DAM, ECAN, EtherGREEN, In-Circuit Serial Programming, ICSP, INICnet, Inter-Chip Connectivity, JitterBlocker, KlearNet, KlearNet logo, memBrain, Mindi, MiWi, MPASM, MPF, MPLAB Certified logo, MPLIB, MPLINK, MultiTRAK, NetDetach, Omniscient Code Generation, PICDEM, PICDEM.net, PICKit, PICtail, PowerSmart, PureSilicon, QMatrix, REAL ICE, Ripple Blocker, SAM-ICE, Serial Quad I/O, SMART-I.S., SQI, SuperSwitcher, SuperSwitcher II, Total Endurance, TSHARC, USBCheck, VariSense, ViewSpan, WiperLock, Wireless DNA, and ZENA are trademarks of Microchip Technology Incorporated in the U.S.A. and other countries.

SQTP is a service mark of Microchip Technology Incorporated in the U.S.A.

The Adaptec logo, Frequency on Demand, Silicon Storage Technology, and Symmcom are registered trademarks of Microchip Technology Inc. in other countries.

GestIC is a registered trademark of Microchip Technology Germany II GmbH & Co. KG, a subsidiary of Microchip Technology Inc., in other countries.

All other trademarks mentioned herein are property of their respective companies.

© 2019, Microchip Technology Incorporated, All Rights Reserved.

ISBN: 978-1-5224-5370-3

For information regarding Microchip's Quality Management Systems, please visit www.microchip.com/quality.



MICROCHIP

Worldwide Sales and Service

AMERICAS

Corporate Office
2355 West Chandler Blvd.
Chandler, AZ 85224-6199
Tel: 480-792-7200
Fax: 480-792-7277
Technical Support:
<http://www.microchip.com/support>
Web Address:
www.microchip.com

Atlanta

Duluth, GA
Tel: 678-957-9614
Fax: 678-957-1455

Austin, TX

Tel: 512-257-3370

Boston

Westborough, MA
Tel: 774-760-0087
Fax: 774-760-0088

Chicago

Itasca, IL
Tel: 630-285-0071
Fax: 630-285-0075

Dallas

Addison, TX
Tel: 972-818-7423
Fax: 972-818-2924

Detroit

Novi, MI
Tel: 248-848-4000

Houston, TX

Tel: 281-894-5983

Indianapolis

Noblesville, IN
Tel: 317-773-8323
Fax: 317-773-5453
Tel: 317-536-2380

Los Angeles

Mission Viejo, CA
Tel: 949-462-9523
Fax: 949-462-9608
Tel: 951-273-7800

Raleigh, NC

Tel: 919-844-7510

New York, NY

Tel: 631-435-6000

San Jose, CA

Tel: 408-735-9110
Tel: 408-436-4270

Canada - Toronto

Tel: 905-695-1980
Fax: 905-695-2078

ASIA/PACIFIC

Australia - Sydney
Tel: 61-2-9868-6733

China - Beijing
Tel: 86-10-8569-7000

China - Chengdu
Tel: 86-28-8665-5511

China - Chongqing
Tel: 86-23-8980-9588

China - Dongguan
Tel: 86-769-8702-9880

China - Guangzhou
Tel: 86-20-8755-8029

China - Hangzhou
Tel: 86-571-8792-8115

China - Hong Kong SAR
Tel: 852-2943-5100

China - Nanjing
Tel: 86-25-8473-2460

China - Qingdao
Tel: 86-532-8502-7355

China - Shanghai
Tel: 86-21-3326-8000

China - Shenyang
Tel: 86-24-2334-2829

China - Shenzhen
Tel: 86-755-8864-2200

China - Suzhou
Tel: 86-186-6233-1526

China - Wuhan
Tel: 86-27-5980-5300

China - Xian
Tel: 86-29-8833-7252

China - Xiamen
Tel: 86-592-2388138

China - Zhuhai
Tel: 86-756-3210040

ASIA/PACIFIC

India - Bangalore
Tel: 91-80-3090-4444

India - New Delhi
Tel: 91-11-4160-8631

India - Pune
Tel: 91-20-4121-0141

Japan - Osaka
Tel: 81-6-6152-7160

Japan - Tokyo
Tel: 81-3-6880-3770

Korea - Daegu
Tel: 82-53-744-4301

Korea - Seoul
Tel: 82-2-554-7200

Malaysia - Kuala Lumpur
Tel: 60-3-7651-7906

Malaysia - Penang
Tel: 60-4-227-8870

Philippines - Manila
Tel: 63-2-634-9065

Singapore
Tel: 65-6334-8870

Taiwan - Hsin Chu
Tel: 886-3-577-8366

Taiwan - Kaohsiung
Tel: 886-7-213-7830

Taiwan - Taipei
Tel: 886-2-2508-8600

Thailand - Bangkok
Tel: 66-2-694-1351

Vietnam - Ho Chi Minh
Tel: 84-28-5448-2100

EUROPE

Austria - Wels
Tel: 43-7242-2244-39
Fax: 43-7242-2244-393

Denmark - Copenhagen
Tel: 45-4450-2828
Fax: 45-4485-2829

Finland - Espoo
Tel: 358-9-4520-820

France - Paris
Tel: 33-1-69-53-63-20
Fax: 33-1-69-30-90-79

Germany - Garching
Tel: 49-8931-9700

Germany - Haan
Tel: 49-2129-3766400

Germany - Heilbronn
Tel: 49-7131-72400

Germany - Karlsruhe
Tel: 49-721-625370

Germany - Munich
Tel: 49-89-627-144-0
Fax: 49-89-627-144-44

Germany - Rosenheim
Tel: 49-8031-354-560

Israel - Ra'anana
Tel: 972-9-744-7705

Italy - Milan
Tel: 39-0331-742611
Fax: 39-0331-466781

Italy - Padova
Tel: 39-049-7625286

Netherlands - Drunen
Tel: 31-416-690399
Fax: 31-416-690340

Norway - Trondheim
Tel: 47-7288-4388

Poland - Warsaw
Tel: 48-22-3325737

Romania - Bucharest
Tel: 40-21-407-87-50

Spain - Madrid
Tel: 34-91-708-08-90
Fax: 34-91-708-08-91

Sweden - Gothenberg
Tel: 46-31-704-60-40

Sweden - Stockholm
Tel: 46-8-5090-4654

UK - Wokingham
Tel: 44-118-921-5800
Fax: 44-118-921-5820