

Aug.1.2020 Copyright 2020 HIROSE ELECTRIC CO., LTD. All Rights Reserved.
In case of consideration for using Automotive equipment / device which demand high reliability, kindly contact our sales window correspondents.

△數 COUNT	訂正事項 DISCRPTION OF REVISIONS	擔當 B Y	檢圖 CHKD	年月日 DATE	△數 COUNT	訂正事項 DISCRPTION OF REVISIONS	擔當 B Y	檢圖 CHKD	年月日 DATE
5	RE-5-1588	N.J.W	A.B.H	17. 02. 27					

REFERENCE DRAWING

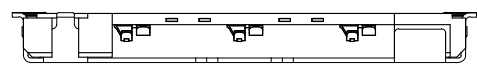

△4 RECOMMEND PCB PATTERN LAYOUT (TOLERANCE : ±0.05)
RECOMMEND METAL MASK THICKNESS = 0.12mm

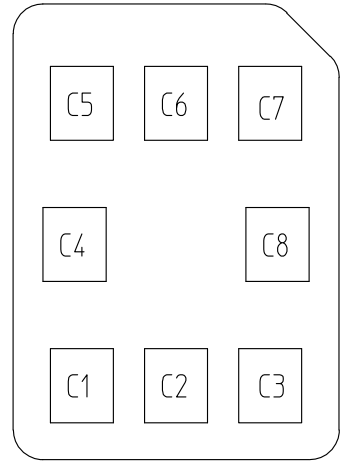
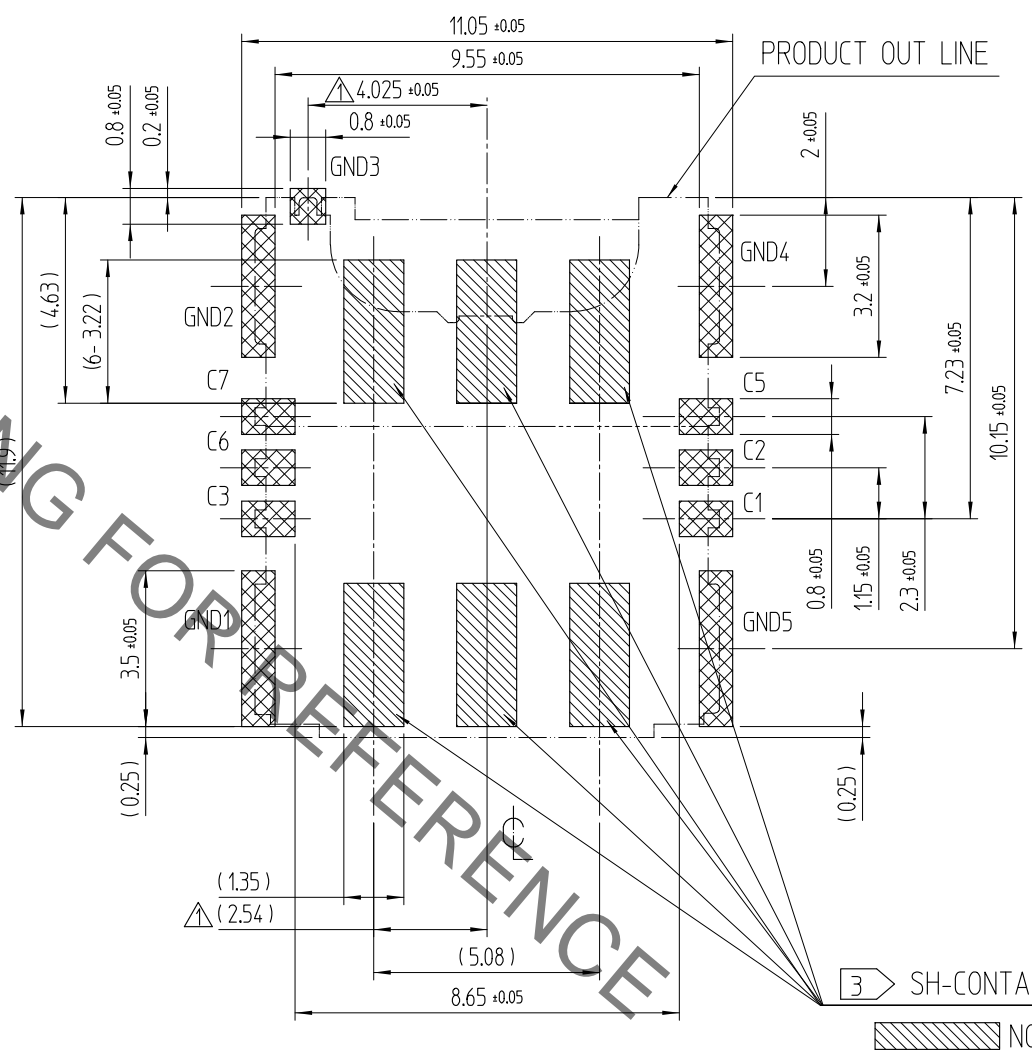
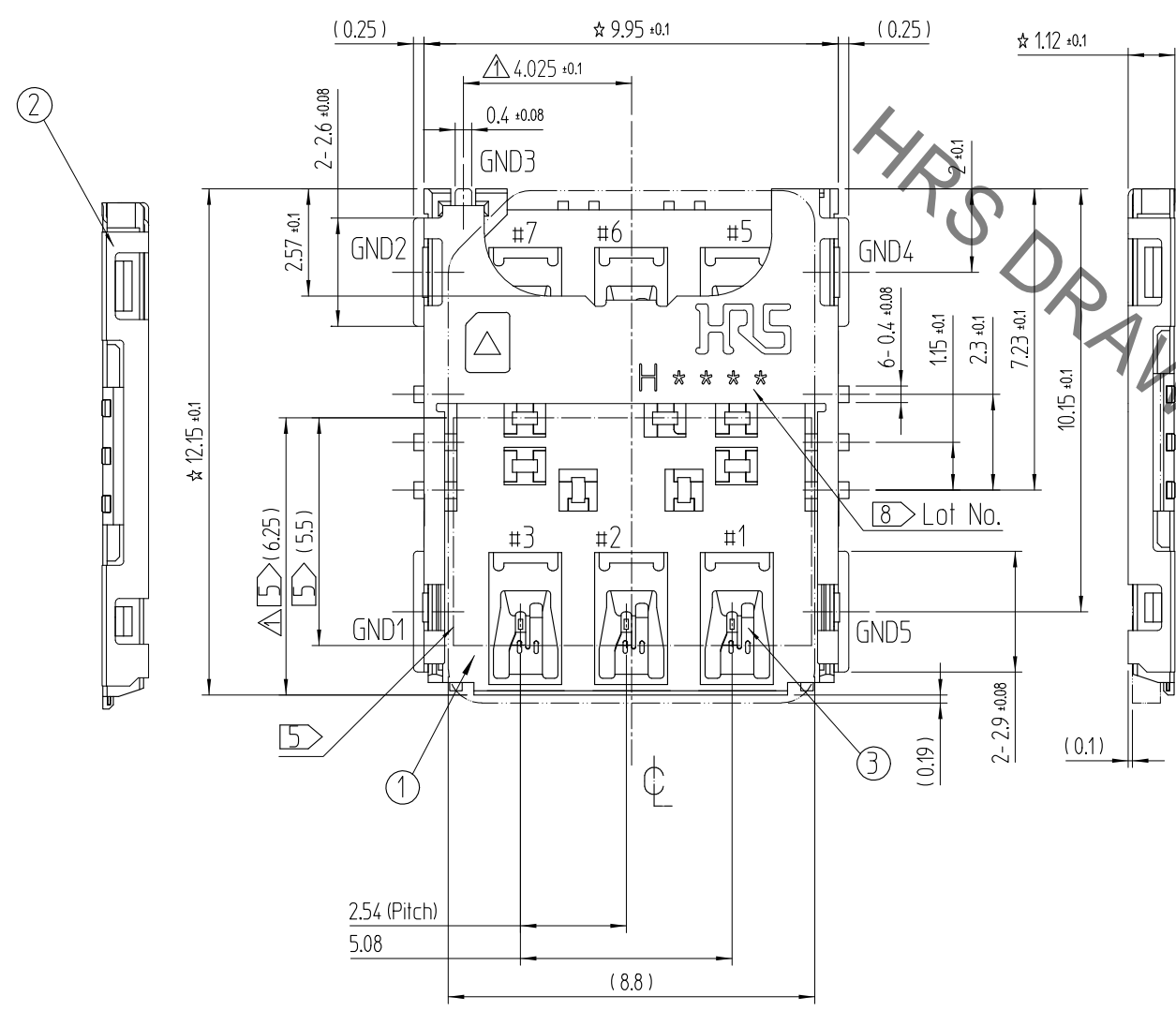

NANO SIM CARD PAD LAY OUT

PIN No.	Name
C1	Vcc
C2	RST
C3	CLK
C5	GND
C6	Vpp
C7	I/O

NANO SIM CARD ASSIGNMENT

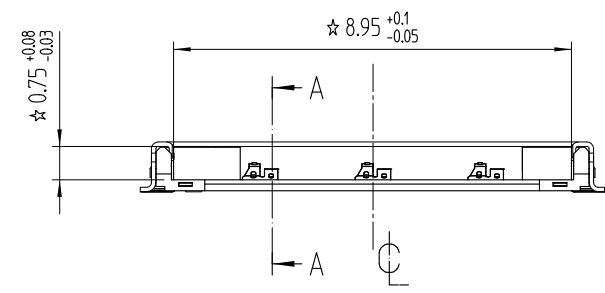

NO.	PART	MATERIAL	FINISH,REMARKS	NO.	PART	MATERIAL	FINISH,REMARKS
2	COVER	STAINLESS STEEL	MOUNTING : NIP + AuP	3	SH-CONTACT	COPPER ALLOY	CONTACT : NP + Pd-Ni + AuP MOUNTING : NIP + AuP
1	Ins.Base	LCP	BLACK / UL94-V0				

CODE NO. (OLD)	DRAWN	DESIGNED	CHECKED	APPROVED	RELEASED
	M.J.CHEON 15.03.02	M.J.CHEON 15.03.02	J.H.CHOI 15.03.02	H.C.SONG 15.03.02	ENG 17.02.28 DEPT

TITLE	DRAWING NO.	PART NO.	CODE NO.
SINGLE PUSH-PULL CARD SOCKET	EDC3-631864	KP13CH-6S-SF(800)	6530-0006-0-800

UNLESS OTHERWISE SPECIFIED, SEE TABLE FOR TOLERANCES

寸分区分 OVER	公差 TOLERANCE
0 6	± 0.05
6 15	± 0.08
15 30	± 0.1
30 60	± 0.15

角度 ANGULAR ± 1°

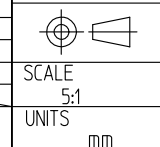

Aug.1.2020 Copyright 2020 HIROSE ELECTRIC CO., LTD. All Rights Reserved.
 In case of consideration for using Automotive equipment / device which demand high reliability, kindly contact our sales window correspondents.

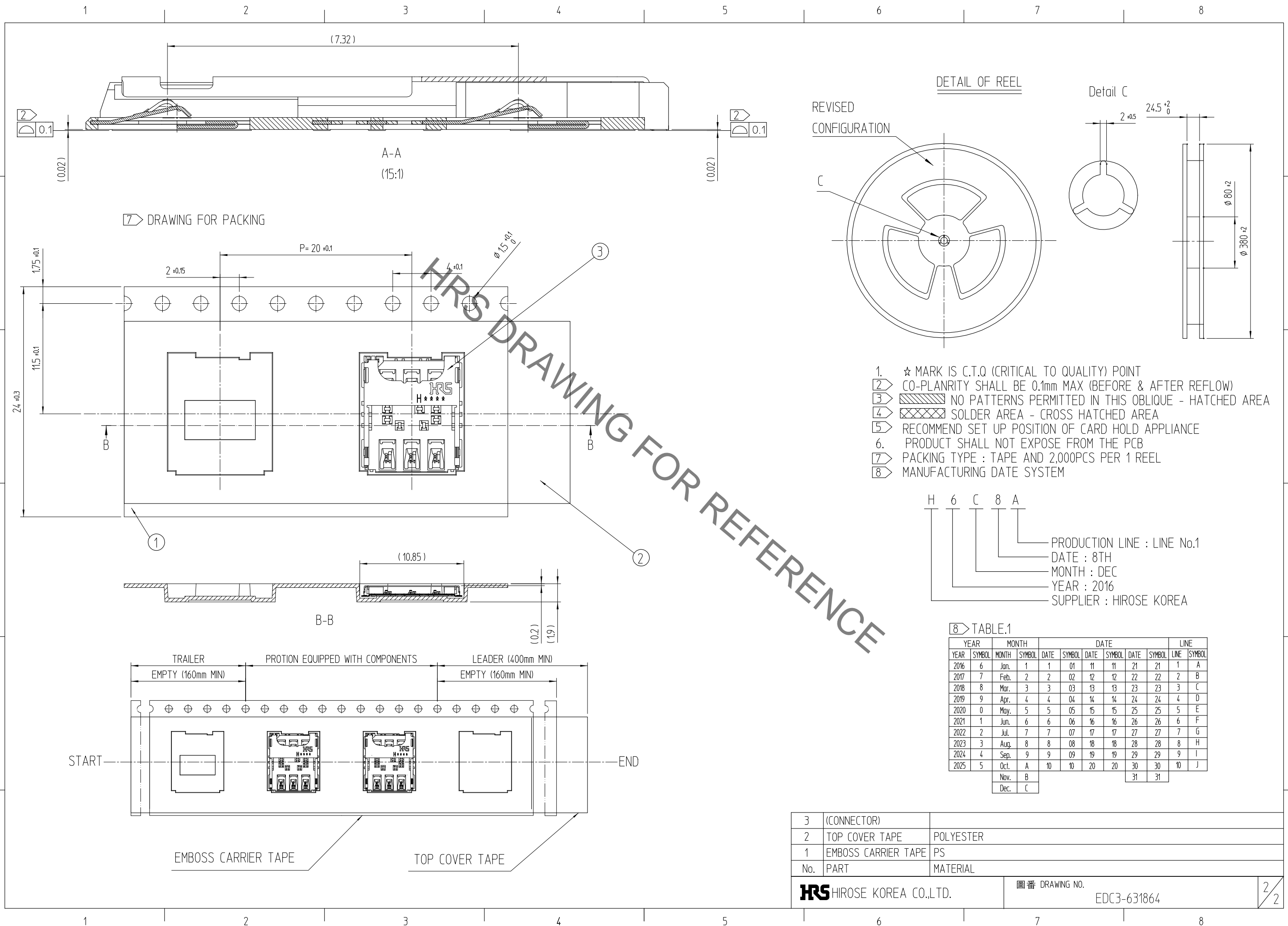

DETAIL OF REEL

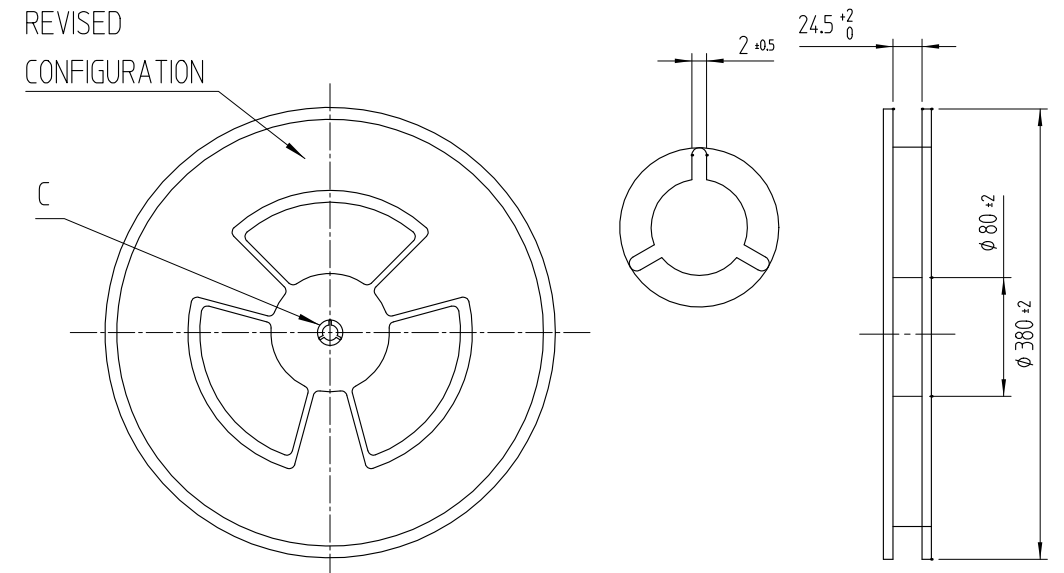

1. ☆ MARK IS C.T.Q (CRITICAL TO QUALITY) POINT
2. CO-PLANRITY SHALL BE 0.1mm MAX (BEFORE & AFTER REFLOW)
3. NO PATTERNS PERMITTED IN THIS OBLIQUE - HATCHED AREA
4. SOLDER AREA - CROSS HATCHED AREA
5. RECOMMEND SET UP POSITION OF CARD HOLD APPLIANCE
6. PRODUCT SHALL NOT EXPOSE FROM THE PCB
7. PACKING TYPE : TAPE AND 2,000PCS PER 1 REEL
8. MANUFACTURING DATE SYSTEM

H 6 C 8 A
 PRODUCTION LINE : LINE No.1
 DATE : 8TH
 MONTH : DEC
 YEAR : 2016
 SUPPLIER : HIROSE KOREA

8 TABLE.1

YEAR	SYMBOL	MONTH	SYMBOL	DATE						LINE	
				DATE	SYMBOL	DATE	SYMBOL	DATE	SYMBOL	LINE	SYMBOL
2016	6	Jan.	1	1	01	11	11	21	21	1	A
2017	7	Feb.	2	2	02	12	12	22	22	2	B
2018	8	Mar.	3	3	03	13	13	23	23	3	C
2019	9	Apr.	4	4	04	14	14	24	24	4	D
2020	0	May.	5	5	05	15	15	25	25	5	E
2021	1	Jun.	6	6	06	16	16	26	26	6	F
2022	2	Jul.	7	7	07	17	17	27	27	7	G
2023	3	Aug.	8	8	08	18	18	28	28	8	H
2024	4	Sep.	9	9	09	19	19	29	29	9	I
2025	5	Oct.	A	10	10	20	20	30	30	10	J
		Nov.	B					31	31		
		Dec.	C								

3	(CONNECTOR)	
2	TOP COVER TAPE	POLYESTER
1	EMBOSS CARRIER TAPE	PS
No.	PART	MATERIAL
HIROSE KOREA CO.,LTD.		圖番 DRAWING NO. EDC3-631864