

**M12 FEMALE 90° FIELD-WIREABLE SCREW TERM.**5-pol. max.0,75mm<sup>2</sup> 6-8mm

Plastic housings with good resistance against chemicals and oils. The resistance to aggressive media should be individually tested for your application. Further details on request.

[Link to Product](#)**Illustration**

# Female

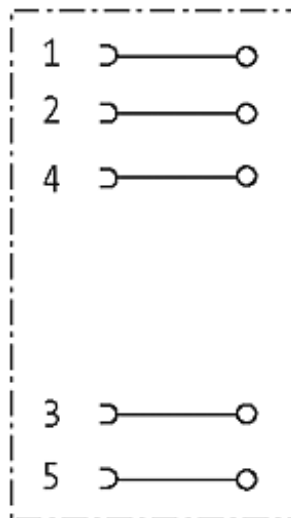
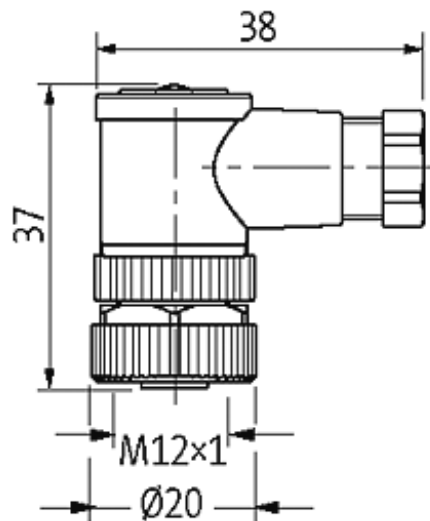
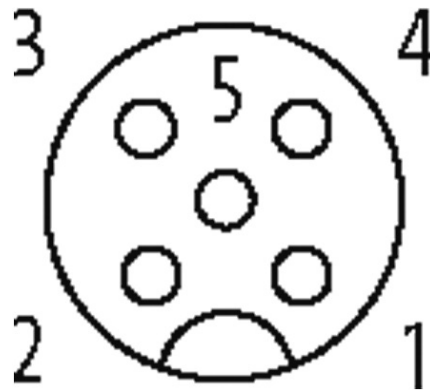

Product may differ from Image

## Approvals



## Form

Form 13041

## Technical Data

Operating voltage	max. 125 V AC/DC
Operating current per contact	max. 4 A
Connection cross section	max. 0.75 mm <sup>2</sup>
Sealing range (cable Ø)	6...8 mm
Locking of ports	Screw thread M12 × 1 mm (recommended torque 0.6 Nm) self-securing

The information in this brochure has been compiled with the utmost care.

Liability for the correctness completeness and topicality of the information is restricted to gross negligence. Version: 08/17

Murrelektronik GmbH | Falkenstraße 3 | 71570 Oppenweiler | Fon +49 (71 91) 47-0 | Fax +49 (71 91) 47-491000 | shop@murrelektronik.com | shop.murrelektronik.com

Protection IP67 inserted and tightened (EN 60529)

**General data**

Temperature range -25...+85 °C

**Commercial data**

country of origin	DE
customs tariff number	85369010
EAN	4048879201490
eClass	27279221
minimum order quantity	1